

COMET ELECTRONICS

PRICE LIST

October 1, 2001

The prices in this catalogue are given in USD, EXW Sofia

**The prices of Comet Electronics are not fixed.
They could be changed due to the current market conditions.
For valid information please contact our Web sites**

**www.comet.bg
www.comet.srl.ro**

Dear Customers,

Comet Electronics offers:

- sales of electronic components from its stock located in Sofia. The basic items of it are included in the current price list;
- supply of components not included in the list. For small quantities the items are ordered via our partner Premier Farnell plc, which includes Farnell, Newark and CPC. Bigger quantities are offered via more than 60 different sources – manufacturers or distributors all over the world;
- technological equipment and consumables for the electronic manufacturing technology;
- **sales via the virtual shop at the following address: www.comet.bg.** Different methods of payment are offered, debit cards included.

Every day more than 35 employees of Comet Electronics receive and handle dozens inquiries.

From the received quotations, data bases, catalogs and price lists they choose and offer you the optimum quotation.

Every day a great number of shipments from all the world are handled. And all this is done for you - to be more flexible and competitive on the severe world market of electronic devices.

CONTENTS

SMD	7
Integrated Circuits SMD	7
Comparators SMD	7
Operational Amplifiers SMD	7
Operational Amplifiers MICROCHIP SMD	7
Voltage Regulators SMD	7
Static RAMs SMD	7
EEPROMs SMD	7
Miscellaneous ICs SMD	7
CMOS 4000 series SMD	8
IC 74HC series SMD	8
IC 74HCT series SMD	9
Opto-couplers SMD	9
Resistors SMD 0805 MCR10 ROHM 5%	9
Resistors SMD 0805 MCR10 ROHM 1%	11
Resistors SMD 1206 MCR18 ROHM 5%	12
Resistors SMD 1206 MCR18 ROHM 1%	12
Ceramic Capacitors SMD 0805 MCH21 ROHM	13
Ceramic Capacitors SMD 1206 MCH31 ROHM	15
Tantlium Capacitors SMD ROHM	16
Zener Diodes 500mV MINI-MELF BZV	16
Zener Diodes 200mV SMD SOD-323 ROHM	16
Transistors SMD	17
Digital Transistors ROHM	17
Diodes SMD	19
Operational Amplifiers	19
Comparators	20
Timers	20
Miscellaneous	20
Security	21
Receiver/Transmitter Modules	22
Voltage References	22
ADC, S/H, V/F	22
Interface ICs	22
Driver ICs	23
Final Stage ICs	23
Linear Voltage Regulators	23
Pulse Voltage Regulators	24
EPROMs	24
EEPROMs - I ² C BUS	24
EEPROMs - SPI BUS	25
EEPROM - MICROWIRE BUS	25
FLASH	25
TTL PROM	25
GAL	25
STATIC RAMs	26
Microcontrollers 68HC series	26
Microcontrollers 8080 series	26
Microcontrollers Atmel 89C series	26
Microcontrollers Zilog Z80 series	26
Microchip	27
PIC Microcontrollers	27
CMOS 4000 Series	32
ICs 74HC Series	33
ICs 74HCT Series	35
TTL Standard Series	36
TTL IC - LS Series	36
Transistors 2N,PN	38
Transistors 2S	38
Transistors BC	38

CONTENTS

Transistors BD,BDX	38
Transistors BF,BFG,BFR,BFY,BGY	39
Transistors BU,BUT	39
Transistors MJE, MPSA	39
Transistors TIP	39
Transistors ZETEX E-Line~TO92	39
Transistors FET ZETEX	40
Transistors FET	40
Power MOS FET	40
Power IGBT Transistors	40
Diodes up to 0.3A	41
Diodes up to 1A	41
Diodes up to 5A	41
Diodes above 5A	41
Bridge Rectifiers	41
Diacs	43
Triacs	43
Zener Diodes 500 mW DO35	43
Zener Diodes 1.3 W	44
LCD Matrix Modules	44
LCD Graphic Modules	44
LED Dot Matrix Displays	49
LED Light Bars	49
LED Displays	49
LED Lamps	50
SMD LEDs	52
IR Devices	52
Opto-couplers with transistor output	52
Opto-couplers with triac output	53
Opto-couplers with air gap	53
Fuses	55
Resettable Fuses	55
Low cost sockets 2.54 mm	55
HIGH DENSITY Sockets 1.778 mm	55
PLCC Sockets	56
PLCC SMD Sockets	56
Machined Pins Sockets	56
Thermal Blocks	56
Relays	58
Connectors	59
Cable Ties	66
Head Shrinking Sleeves	66
Mechanical Accessories	66
Bobbins	69
Switches	69
Indicator Lights	72
Buzzers and Microphones	73
Crystals	74
Quartz Oscillators	74
Ceramic Resonators and Filters	74
Ferrite Cores KASCHKE	74
R.F. Coils	75
Fixed Inductors	75
Varistors	77
Resistors	77
Resistor Networks	85
R - Trimmers	85
Potentiometers	87
Trimmer Capacitors	87
Tantalum Capacitors	87
Capacitors MPT111	87

CONTENTS

Capacitors MPT221 88
Capacitors WIMA 88
Electrolytic capacitors 89
Batteries 91
Development Tools 91
Enclosures 92
Enclosures PacTec 92
Enclosures BERNIC 93

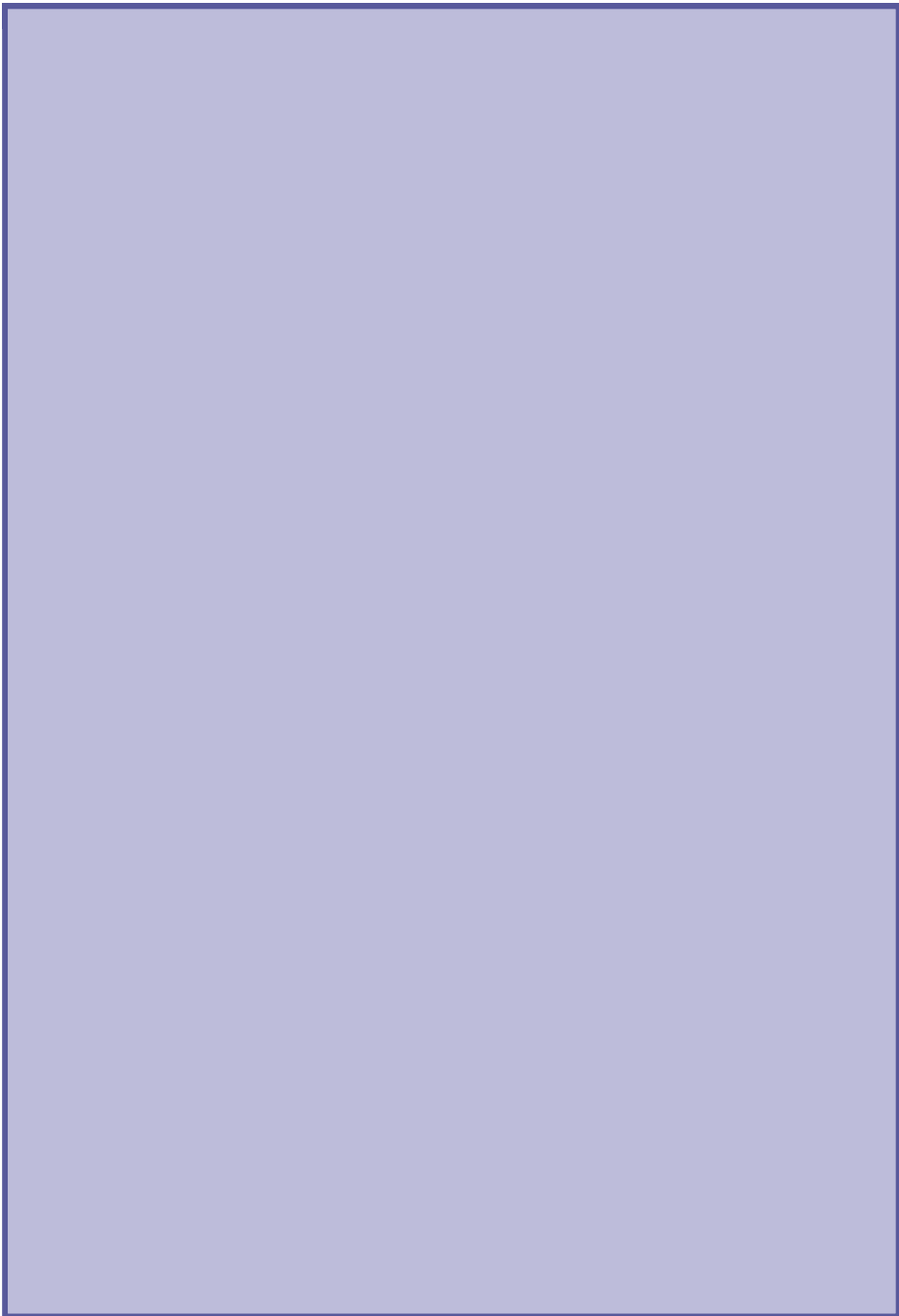

Integrated Circuits SMD							
Comparators SMD			1-4	5-24	25-99	100-499	500+
LM239D SMD	SO14 4 Voltage Comparators		0.210	0.189	0.174	0.162	0.150
LM311D SMD	SO8 Voltage Comparator		0.299	0.269	0.248	0.231	0.214
LM339D SMD	SO14 4 Voltage Comparators		0.155	0.140	0.129	0.120	0.111
LM339F ROHM SMD	SO14 4 Voltage Comparators		0.154	0.138	0.127	0.119	0.110
LM393D SMD	SO8 2 Comparators		0.177	0.161	0.142	0.131	
LM393F ROHM SMD	SO8 2 Comparators		0.161	0.145	0.133	0.124	0.115
Operational Amplifiers SMD			1-4	5-24	25-99	100-499	500+
LM324D SMD	SO14 4 Operational Amplifiers		0.166	0.149	0.137	0.128	
LM324AF ROHM SMD	SO14 4 Operational Amplifiers		0.189	0.170	0.157	0.146	0.135
LM358D SMD	SO8 2 Operational Amplifiers		0.152	0.137	0.126	0.118	0.109
LM358F ROHM SMD	SO8 2 Operational Amplifiers		0.154	0.138	0.127	0.119	0.110
LMC555CD (7555) SMD	SO8 2 Operational Amplifiers		0.196	0.176	0.162	0.151	
NE555D SMD	SO8 Timer		0.167	0.150	0.138	0.129	0.119
TL064CD SMD	SO14 4 Operational Amplifiers JFET		0.289	0.260	0.239	0.223	
TL074CD SMD	SO14 4 Operational Amplifiers JFET		0.291	0.262	0.241	0.224	
TL082CD SMD	SO8 2 Operational Amplifiers JFET		0.206	0.186	0.171	0.159	
TL084CD SMD	SO14 4 Operational Amplifiers JFET		0.278	0.250	0.230	0.214	
Operational Amplifiers MICROCHIP SMD			1-4	5-24	25-99	100-499	500+
MCP601-I/SN	SO8 1 OA 2mV, 1pA, 2.7-5.5V, 230uA, 2.8MHz		0.502	0.456	0.409	0.386	
MCP602-I/SN	SO8 2 OA 2mV, 1pA, 2.7-5.5V, 230uA, 2.8MHz		0.651	0.591	0.531	0.501	
MCP602-I/SN SLS	SO8 2 OA 2mV, 1pA, 2.7-5.5V, 230uA, 2.8MHz		0.651	0.591	0.531	0.501	
MCP603-I/SN	SO8 1 OA C/S 2mV, 1pA, 2.7-5.5V, 230uA, 2.8		0.521	0.472	0.424	0.400	
MCP603-I/SN SLS	SO8 1 OA C/S 2mV, 1pA, 2.7-5.5V, 230uA, 2.8		0.521	0.472	0.424	0.400	
MCP604-I/SL	SO8 4 OA 2mV, 1pA, 2.7-5.5V, 230uA, 2.8MHz		1.190	1.080	0.970	0.915	
MCP604-I/SL SLS	SO8 4 OA 2mV, 1pA, 2.7-5.5V, 230uA, 2.8MHz		1.190	1.080	0.970	0.915	
MCP606-I/SN	SO8 1 OA 0.2mV, 1pA, 2.7-5.5V, 25uA, 155kHz		0.744	0.675	0.606	0.572	
MCP607-I/SN	SO8 2 OA 0.2mV, 1pA, 2.7-5.5V, 25uA, 155kHz		0.985	0.894	0.803	0.758	
MCP608-I/SN	SO8 1 OA C/S 0.2mV, 1pA, 2.7-5.5V, 25uA		0.799	0.726	0.652	0.615	
MCP609-I/SL	SO8 4 OA 0.2mV, 1pA, 2.7-5.5V, 25uA, 155kHz		1.487	1.350	1.213	1.144	
Voltage Regulators SMD			1-4	5-24	25-99	100-499	500+
7805FP ROHM SMD	T0252-3 5V 1A		0.302	0.263	0.250	0.237	0.224
78L05 SMD	SO8 5V 100mA		0.134	0.117	0.111	0.105	0.099
78L08 SMD	SO8 8V 100mA		0.143	0.124	0.118	0.112	0.106
78L12 SMD	SO8 12V 100mA		0.133	0.116	0.110	0.104	0.098
MC34063AD SMD	SO8		0.431	0.375	0.357	0.338	0.319
Static RAMs SMD			1-4	5-24	25-99	100+	
6264LP-70 SMD	SOP28 SRAM 8K x 8 Low Power		1.230	1.116	1.003	0.946	
62256LP-70 SMD	SOP28 SRAM 32K x 8 Low Power		2.195	1.993	1.790	1.689	
628128LP-70 SMD	SOP32 SRAM 128K x 8 Low Power		2.909	2.641	2.372	2.238	
EEPROMs SMD			1-24	25-99	100-499	500+	
24LC00T-I/OT SMD	16 byte, 128 bit, 2.5V SEE		0.262	0.231	0.218	0.210	
24LC01B/P	1K, 128 X 8 2.5V SERIAL EE		0.384	0.338	0.320	0.307	
24C02 SMD	SOP8 EEPROM 2K I2C bus		0.383	0.337	0.319	0.307	
24C02 BR24C02F-W SMD	SOP8 EEPROM 2K I2C bus		0.337	0.297	0.281	0.270	
24C04 SMD	SOP8 EEPROM 4K I2C bus		0.331	0.292	0.276	0.265	
24C04 BR24C04F-W SMD	SOP8 EEPROM 2K I2C bus		0.370	0.325	0.307	0.296	
24C08 SMD	SOP8 EEPROM 8K I2C bus		0.418	0.368	0.348	0.335	
24C16 SMD	SOP8 EEPROM 16K I2C bus		0.473	0.417	0.394	0.379	
93LC46/SN SMD	EEPROM 1K SMD		0.454	0.395	0.367	0.349	
93C46 SMD	SOP8 EEPROM 1K		0.388	0.337	0.313	0.299	
93LC66B-I/SN SMD	EEPROM 4K SMD		0.454	0.395	0.367	0.349	
Miscellaneous ICs SMD			1-4	5-24	25-99	100+	
ULN2003D1 SMD	7 channel Darlington driver 0.5A 2.4V		0.223	0.189	0.180	0.171	
ULN2004D1 SMD	7 channel Darlington driver 0.5A 5V		0.202	0.171	0.163	0.155	
ULN2803AFW SMD	8 channel Darlington driver 0.5A 2.4V		0.314	0.266	0.254	0.242	
ULN2804AFW SMD	8 channel Darlington driver 0.5A 5V		0.314	0.266	0.254	0.242	

Miscellaneous ICs SMD		1-4	5-24	25-99	100+
LT1181ACS SMD	RS232 transceiver	3.836	3.479	3.381	3.251
75176 SMD	SO-8 RS485/RS422 bidirectional transceiver	0.495	0.419	0.400	0.381
MAX232(ST232) SMD	SO-16 RS232 driver/receiver	0.648	0.549	0.524	0.499
MC1488D SMD	SO-14 RS232 driver	0.211	0.179	0.171	0.162
MC1489AD SMD	SO-14 RS232 receiver	0.211	0.179	0.171	0.162
UT103 SMD	SOIC universal transducer interface	3.469	3.146	3.058	2.940
7106 SMD	PQFP44 ADC 3 1/2 LCD 333 mS	4.440	4.026	3.913	3.763
CMOS 4000 series SMD		1-4	5-24	25-99	100+
4001 SMD	4 x 2 INP NOR+INV	0.136	0.120	0.115	0.109
4001 ROHM SMD	SOP14 4 x 2 INP NOR+INV	0.185	0.163	0.155	0.148
4006 SMD	18 STAGE SHIFT REG.	0.282	0.248	0.237	0.225
4011 SMD	4 x 2 INP NAND	0.110	0.097	0.092	0.088
4011 ROHM SMD	SOP14 4 x 2 INP NAND	0.177	0.155	0.148	0.141
4013 SMD	2 D FLIP-FLOP	0.143	0.126	0.120	0.115
4017 SMD	DECADE COUNTER/DIVIDER	0.196	0.173	0.165	0.157
4018 SMD	PRESETTABLE DIVIDE-"N" COUNTER	0.358	0.315	0.301	0.286
4023 SMD	3 x 3 INP NAND	0.209	0.184	0.176	0.167
4024 SMD	7-STAGE BINARY/RIPPLE COUNTER	0.347	0.306	0.292	0.278
4025 SMD	3 x 3 INP NOR	0.171	0.151	0.144	0.137
4027 SMD	2 J-K MASTER-SLAVE FLIP-FLOP	0.284	0.250	0.238	0.227
4040 SMD	12-STAGE BINARY/RIPPLE COUNTER	0.187	0.165	0.157	0.150
4049 SMD	6 INVERTING BUFFER/CONVERTER	0.129	0.114	0.109	0.104
4050 SMD	6 NON-INVERTING BUFFER/CONVERTER	0.133	0.117	0.112	0.107
4051 SMD	8-CHANNEL AN. MULTIPLEXER/DEMUTIPLEXER	0.200	0.176	0.168	0.160
4051 ROHM SMD	8-CHANNEL AN. MULTIPLEXER/DEMUTIPLEXER	0.238	0.210	0.200	0.191
4052 SMD	2x4-CHANNEL AN. MULTIPLEXER/DEMUTIP.	0.165	0.146	0.139	0.132
4053 SMD	3x2-CHANNEL AN. MULTIPLEXER/DEMUTIP.	0.167	0.147	0.140	0.133
4060 SMD	14-STAGE COUNTER/DIVIDER AND OSC.	0.228	0.200	0.191	0.182
4066 SMD	4 BILATERAL SWITCH	0.176	0.155	0.148	0.141
4069 SMD	6 INVERTER	0.116	0.102	0.097	0.093
4071 SMD	4x2-INPUT OR GATE	0.116	0.102	0.097	0.093
4093 SMD	4x2-IMP NAND SCHMITT TRIGGER	0.124	0.109	0.104	0.099
4094 SMD	8-STAGE SHIFT-AND-STORE BUS REG	0.193	0.170	0.162	0.155
4508 SMD	2x4-BIT LATCH (3-STATE OUTP)	0.744	0.655	0.625	0.595
4538 SMD	2 PRECISION MONOSTABLE MULTIVIBRATOR	0.277	0.244	0.233	0.222
4541 SMD	PROGRAMMABLE TIMER	0.203	0.178	0.170	0.162
IC 74HC series SMD		1-4	5-24	25-99	100+
74HC00 SMD	4x2-IMP NAND	0.138	0.121	0.116	0.110
74HC02 SMD	4x2-IMP NOR	0.111	0.098	0.093	0.089
74HC04 SMD	6 INVERTER	0.111	0.097	0.093	0.089
74HC05 SMD	6 INVERTER O.D.	0.117	0.103	0.098	0.093
74HC08 SMD	4x2-IMP AND	0.105	0.092	0.088	0.084
74HC10 SMD	3x3-IMP NAND	0.110	0.097	0.092	0.088
74HC14 SMD	6 INVERTING SCHMITT TRIGGER	0.133	0.117	0.112	0.106
74HC32 SMD	4x2-IMP OR	0.111	0.097	0.093	0.089
74HC74 SMD	2 D FLIP-FLOP WITH PRESET AND CLEAR	0.113	0.099	0.095	0.090
74HC85 SMD	4-BIT MAGNITUDE COMPARATOR	0.141	0.124	0.118	0.113
74HC123 SMD	2 RETRIGGERABLE MONOSTABLE	0.154	0.135	0.129	0.123
74HC125 SMD	3-STATE 4 BUFFERS	0.168	0.148	0.141	0.135
74HC126 SMD	3-STATE 4 BUFFERS	0.120	0.105	0.100	0.096
74HC132 SMD	4x2-IMP NAND SCHMITT TRIGGER	0.156	0.137	0.131	0.125
74HC138 SMD	3-TO-8 LINE DECODER	0.152	0.134	0.128	0.122
74HC139 SMD	2x2-TO-4 LINE DECODER	0.138	0.122	0.116	0.111
74HC164 SMD	8-BIT SERIAL-IN/PARALLEL-OUT SHIFT REG	0.165	0.145	0.138	0.132
74HC165 SMD	8-BIT PAR.IN/SER. OUT SHIFT REG.	0.193	0.170	0.162	0.155
74HC244 SMD	8x3-STATE BUFFER	0.207	0.182	0.174	0.166
74HC245 SMD	8x3-STATE TRANSCEIVER	0.183	0.161	0.153	0.146
74HC273 SMD	8 D FLIP-FLOPS WITH CLEAR	0.191	0.168	0.160	0.153
74HC373 SMD	3-STATE 8 D-TYPE LATCH	0.185	0.163	0.156	0.148
74HC374 SMD	3-STATE 8 D-TYPE FLIP-FLOP	0.185	0.163	0.156	0.148
74HC573 SMD	3-STATE 8 D-TYPE LATCH	0.188	0.165	0.158	0.150
74HC574 SMD	3-STATE 8 D-TYPE EDGE-TRIGG. FLIP-FLOP	0.186	0.164	0.156	0.149
74HC595 SMD	8 BIT SERIAL TO PARALLEL SHIFT REGISTER	0.215	0.189	0.180	0.172
74HC597 SMD		0.303	0.267	0.255	0.243

IC 74HC series SMD		1-4	5-24	25-99	100+	
74HC4040 SMD	12-BIT BINARY COUNTER	0.198	0.174	0.166	0.158	
74HC4051 SMD	8-CHANNEL AN. MULTIPLEXER/DEMULTIPLEXER	0.194	0.171	0.163	0.155	
74HC4052 SMD	2x4-CHANNEL AN.MULTIPLEXER/DEMULPTIP.	0.194	0.171	0.163	0.155	
74HC4053 SMD	3x2-CHANNEL AN.MULTIPLEXER/DEMULTIPLEXER	0.184	0.162	0.155	0.148	
74HC4060 SMD		0.215	0.189	0.181	0.172	
74HC4066 SMD	4 BILATERAL SWITCH	0.156	0.137	0.131	0.125	
74HC4094 SMD	8-STAGE SHIFT-AND-STORE BUS REG	0.199	0.175	0.167	0.159	
IC 74HCT series SMD		1-4	5-24	25-99	100+	
74HCT00 SMD	4x2-INP NAND	0.107	0.094	0.090	0.086	
74HCT02 SMD	4x2-INP NOR	0.143	0.126	0.120	0.114	
74HCT04 SMD	6 INVERTER	0.109	0.096	0.091	0.087	
74HCT05 SMD	6 INVERTER O.D.	0.113	0.100	0.095	0.091	
74HCT08 SMD	4x2-INP AND	0.105	0.092	0.088	0.084	
74HCT10 SMD	3x3-INP NAND	0.124	0.109	0.104	0.099	
74HCT14 SMD	6 INVERTING SCHMITT TRIGGER	0.112	0.099	0.094	0.090	
74HCT32 SMD	4x2-INP OR	0.112	0.098	0.094	0.090	
74HCT74 SMD	2 D FLIP-FLOP W PRESET/CLEAR	0.127	0.112	0.107	0.101	
74HCT125 SMD	3-STATE 4 BUFFERS	0.122	0.107	0.102	0.098	
74HCT126 SMD	3-STATE 4 BUFFERS	0.143	0.126	0.120	0.114	
74HCT132 SMD	4x2-INP NAND SCHMITT TRIGGER	0.181	0.160	0.152	0.145	
74HCT138 SMD	3-TO-8 LINE DECODER	0.147	0.129	0.123	0.117	
74HCT164 SMD	8-BIT SERIAL-IN/PARALLEL-OUT SHIFT REG	0.218	0.191	0.183	0.174	
74HCT165 SMD	8-BIT PAR.IN/SER. OUT SHIFT REG.	0.224	0.197	0.188	0.179	
74HCT244 SMD	8x3-STATE BUFFER	0.193	0.170	0.162	0.155	
74HCT245 SMD	8x3-STATE TRANSCEIVER	0.183	0.161	0.153	0.146	
74HCT373 SMD	3-STATE 8 D-TYPE LATCH	0.224	0.197	0.188	0.179	
74HCT374 SMD	3-STATE 8 D-TYPE FLIP-FLOP	0.248	0.218	0.208	0.199	
74HCT573 SMD	3-STATE 8 D-TYPE LATCH	0.237	0.208	0.199	0.189	
74HCT574 SMD	3-STATE 8 D-TYPE EDGE-TRIGGG.FLIP-FLOP	0.256	0.225	0.215	0.205	
74HCT595 SMD	8 BIT SERIAL TO PARALLEL SHIFT REGISTER	0.261	0.230	0.219	0.209	
74HCT597 SMD		0.313	0.276	0.263	0.251	
74HCT4053 SMD	3x2-CHANNEL AN.MULTIPLEXER/DEMULTIPLEXER	0.198	0.174	0.166	0.159	
74HCT4066 SMD	4 BILATERAL SWITCH	0.157	0.138	0.132	0.126	
74HCT4094 SMD	8-STAGE SHIFT-AND-STORE BUS REG	0.191	0.168	0.160	0.153	
Opto-couplers SMD		1-4	5-24	25-99	100+	
4N35S-MOT SMD	100% 70/30V 3.5kV 5/5uS SMD	0.169	0.156	0.141	0.125	
CNY17-4.S SMD	160-320% 70/70V 7.5kV 6/5.5uS SMD	0.176	0.163	0.153	0.135	
H11A817C.S SMD	200-400% 35V 5.3kV 2.4/2.4uS SMD	0.163	0.151	0.141	0.125	
Resistors SMD 0805 MCR10 ROHM		1-9	10-99	100-999	1000+	5000+
0805 5%						
R0805 0R 5% ROHM	RES SMD 0805 JUMPER MAX 2A 50mOhm	0.0180	0.0090	0.0040	0.0030	0.0025
R0805 0.47R 5% ROHM	RES SMD 0805 5% 500ppm 0.47R 1/8W MCR10	0.0250	0.0126	0.0056	0.0042	0.0035
R0805 0.68R 5% ROHM	RES SMD 0805 5% 500ppm 0.68R 1/8W MCR10	0.0250	0.0126	0.0056	0.0042	0.0035
R0805 1R 5% ROHM	RES SMD 0805 5% 500ppm 1R 1/8W MCR10	0.0270	0.0137	0.0061	0.0046	0.0039
R0805 1.2R 5% ROHM	RES SMD 0805 5% 500ppm 1.2R 1/8W MCR10	0.0140	0.0069	0.0031	0.0023	0.0019
R0805 1.5R 5% ROHM	RES SMD 0805 5% 500ppm 1.5R 1/8W MCR10	0.0140	0.0069	0.0031	0.0023	0.0019
R0805 1.8R 5% ROHM	RES SMD 0805 5% 500ppm 1.8R 1/8W MCR10	0.0140	0.0069	0.0031	0.0023	0.0019
R0805 2.2R 5% ROHM	RES SMD 0805 5% 500ppm 2.2R 1/8W MCR10	0.0140	0.0069	0.0031	0.0023	0.0019
R0805 2.7R 5% ROHM	RES SMD 0805 5% 500ppm 2.7R 1/8W MCR10	0.0140	0.0069	0.0031	0.0023	0.0019
R0805 3.3R 5% ROHM	RES SMD 0805 5% 500ppm 3.3R 1/8W MCR10	0.0140	0.0069	0.0031	0.0023	0.0019
R0805 3.9R 5% ROHM	RES SMD 0805 5% 500ppm 3.9R 1/8W MCR10	0.0140	0.0069	0.0031	0.0023	0.0019
R0805 4.7R 5% ROHM	RES SMD 0805 5% 500ppm 4.7R 1/8W MCR10	0.0140	0.0069	0.0031	0.0023	0.0019
R0805 5.6R 5% ROHM	RES SMD 0805 5% 500ppm 5.6R 1/8W MCR10	0.0140	0.0069	0.0031	0.0023	0.0019
R0805 6.8R 5% ROHM	RES SMD 0805 5% 500ppm 6.8R 1/8W MCR10	0.0140	0.0069	0.0031	0.0023	0.0019
R0805 8.2R 5% ROHM	RES SMD 0805 5% 500ppm 8.2R 1/8W MCR10	0.0140	0.0069	0.0031	0.0023	0.0019
R0805 10R 5% ROHM	RES SMD 0805 5% 200ppm 10R 1/8W MCR10	0.0140	0.0069	0.0031	0.0023	0.0019
R0805 12R 5% ROHM	RES SMD 0805 5% 200ppm 12R 1/8W MCR10	0.0140	0.0069	0.0031	0.0023	0.0019
R0805 15R 5% ROHM	RES SMD 0805 5% 200ppm 15R 1/8W MCR10	0.0140	0.0069	0.0031	0.0023	0.0019
R0805 18R 5% ROHM	RES SMD 0805 5% 200ppm 18R 1/8W MCR10	0.0140	0.0069	0.0031	0.0023	0.0019
R0805 22R 5% ROHM	RES SMD 0805 5% 200ppm 22R 1/8W MCR10	0.0140	0.0069	0.0031	0.0023	0.0019
R0805 27R 5% ROHM	RES SMD 0805 5% 200ppm 27R 1/8W MCR10	0.0140	0.0069	0.0031	0.0023	0.0019
R0805 33R 5% ROHM	RES SMD 0805 5% 200ppm 33R 1/8W MCR10	0.0140	0.0069	0.0031	0.0023	0.0019

1206 1%			1-9	10-99	100-999	1000+	5000+
R1206 820R 1% ROHM	RES SMD 1206 1% 100ppm 820R 1/4W MCR18		0.0290	0.0144	0.0069	0.0055	0.0048
R1206 1K 1% ROHM	RES SMD 1206 1% 100ppm 1K 1/4W MCR18		0.0290	0.0144	0.0069	0.0055	0.0048
R1206 1.5K 1% ROHM	RES SMD 1206 1% 100ppm 1.5K 1/4W MCR18		0.0290	0.0144	0.0069	0.0055	0.0048
R1206 1.8K 1% ROHM	RES SMD 1206 1% 100ppm 1.8K 1/4W MCR18		0.0290	0.0144	0.0069	0.0055	0.0048
R1206 2.0K 1% ROHM	RES SMD 1206 1% 100ppm 2.0K 1/4W MCR18		0.0290	0.0144	0.0069	0.0055	0.0048
R1206 2.2K 1% ROHM	RES SMD 1206 1% 100ppm 2.2K 1/4W MCR18		0.0290	0.0144	0.0069	0.0055	0.0048
R1206 3.3K 1% ROHM	RES SMD 1206 1% 100ppm 3.3K 1/4W MCR18		0.0290	0.0144	0.0069	0.0055	0.0048
R1206 3.9K 1% ROHM	RES SMD 1206 1% 100ppm 3.9K 1/4W MCR18		0.0290	0.0144	0.0069	0.0055	0.0048
R1206 4.7K 1% ROHM	RES SMD 1206 1% 100ppm 4.7K 1/4W MCR18		0.0290	0.0144	0.0069	0.0055	0.0048
R1206 6.8K 1% ROHM	RES SMD 1206 1% 100ppm 6.8K 1/4W MCR18		0.0290	0.0144	0.0069	0.0055	0.0048
R1206 10K 1% ROHM	RES SMD 1206 1% 100ppm 10K 1/4W MCR18		0.0290	0.0144	0.0069	0.0055	0.0048
R1206 15K 1% ROHM	RES SMD 1206 1% 100ppm 15K 1/4W MCR18		0.0290	0.0144	0.0069	0.0055	0.0048
R1206 22K 1% ROHM	RES SMD 1206 1% 100ppm 22K 1/4W MCR18		0.0290	0.0144	0.0069	0.0055	0.0048
R1206 33K 1% ROHM	RES SMD 1206 1% 100ppm 33K 1/4W MCR18		0.0290	0.0144	0.0069	0.0055	0.0048
R1206 47K 1% ROHM	RES SMD 1206 1% 100ppm 47K 1/4W MCR18		0.0290	0.0144	0.0069	0.0055	0.0048
R1206 68K 1% ROHM	RES SMD 1206 1% 100ppm 68K 1/4W MCR18		0.0290	0.0144	0.0069	0.0055	0.0048
R1206 100K 1% ROHM	RES SMD 1206 1% 100ppm 100K 1/4W MCR18		0.0290	0.0144	0.0069	0.0055	0.0048
R1206 120K 1% ROHM	RES SMD 1206 1% 100ppm 120K 1/4W MCR18		0.0290	0.0144	0.0069	0.0055	0.0048
R1206 150K 1% ROHM	RES SMD 1206 1% 100ppm 150K 1/4W MCR18		0.0290	0.0144	0.0069	0.0055	0.0048
R1206 220K 1% ROHM	RES SMD 1206 1% 100ppm 220K 1/4W MCR18		0.0290	0.0144	0.0069	0.0055	0.0048
R1206 330K 1% ROHM	RES SMD 1206 1% 100ppm 330K 1/4W MCR18		0.0290	0.0144	0.0069	0.0055	0.0048
R1206 470K 1% ROHM	RES SMD 1206 1% 100ppm 470K 1/4W MCR18		0.0290	0.0144	0.0069	0.0055	0.0048
R1206 680K 1% ROHM	RES SMD 1206 1% 100ppm 680K 1/4W MCR18		0.0290	0.0144	0.0069	0.0055	0.0048
R1206 1M 1% ROHM	RES SMD 1206 1% 100ppm 1M 1/4W MCR18		0.0290	0.0144	0.0069	0.0055	0.0048
R1206 1.5M 1% ROHM	RES SMD 1206 1% 100ppm 1.5M 1/4W MCR18		0.0290	0.0144	0.0069	0.0055	0.0048
R1206 2.2M 1% ROHM	RES SMD 1206 1% 100ppm 2.2M 1/4W MCR18		0.0290	0.0144	0.0069	0.0055	0.0048
R1206 10M 1% ROHM	RES SMD 1206 1% 100ppm 10M 1/4W		0.0290	0.0144	0.0069	0.0055	0.0048
Ceramic Capacitors SMD 0805 MCH21 ROHM			1-9	10-99	100-999	1000+	5000+
C0805 1.5pF 50V COG	1.5pF 50V COG+0.25pF		0.0310	0.0140	0.0101	0.0096	0.0088
C0805 1.8pF 50V COG	1.8pF 50V COG+0.25pF		0.0310	0.0140	0.0101	0.0096	0.0088
C0805 2.2pF 50V COG	2.2pF 50V COG+5%		0.0370	0.0168	0.0121	0.0116	0.0105
C0805 2.7pF 50V COG	2.7pF 50V COG+0.25pF		0.0310	0.0140	0.0101	0.0096	0.0088
C0805 3.3pF 50V COG	3.3pF 50V COG+0.25pF		0.0310	0.0140	0.0101	0.0096	0.0088
C0805 3.9pF 50V COG	3.9pF 50V COG+0.25pF		0.0310	0.0140	0.0101	0.0096	0.0088
C0805 3.9pF 50V U2J	3.9pF 50V U2J-0.25pF		0.0470	0.0216	0.0156	0.0149	0.0135
C0805 4.0pF 50V COG	4.0pF 50V COG+0.25pF		0.0300	0.0137	0.0098	0.0094	0.0085
C0805 4.7pF 50V COG	4.7pF 50V COG+0.25pF		0.0370	0.0168	0.0121	0.0116	0.0105
C0805 5.0pF 50V COG	5.0pF 50V COG+0.25pF		0.0300	0.0137	0.0098	0.0094	0.0085
C0805 5.0pF 50V U2J	5.0pF 50V U2J+0.25pF		0.0440	0.0200	0.0144	0.0138	0.0125
C0805 5.6pF 50V COG	5.6pF 50V COG+0.5pF		0.0310	0.0140	0.0101	0.0096	0.0088
C0805 6.0pF 50V COG	6.0pF 50V COG+0.5pF		0.0300	0.0137	0.0098	0.0094	0.0085
C0805 6.8pF 50V COG	6.8pF 50V COG+0.5pF		0.0310	0.0140	0.0101	0.0096	0.0088
C0805 7.0pF 50V COG	7.0pF 50V COG+0.5pF		0.0300	0.0137	0.0098	0.0094	0.0085
C0805 8.0pF 50V COG	8.0pF 50V COG+0.5pF		0.0300	0.0137	0.0098	0.0094	0.0085
C0805 8.2pF 50V COG	8.2pF 50V COG+0.5pF		0.0310	0.0140	0.0101	0.0096	0.0088
C0805 9.0pF 50V COG	9.0pF 50V COG+0.5pF		0.0300	0.0137	0.0098	0.0094	0.0085
C0805 10pF 50V COG	10pF 50V COG+0.5pF		0.0450	0.0205	0.0147	0.0141	0.0128
C0805 10pF 50V U2J	10pF 50V U2J+0.5pF		0.0410	0.0186	0.0133	0.0128	0.0116
C0805 12pF 50V COG	12pF 50V COG+5%		0.0300	0.0137	0.0098	0.0094	0.0085
C0805 12pF 50V U2J	12pF 50V U2J+5%		0.0410	0.0186	0.0133	0.0128	0.0116
C0805 13pF 50V COG	13pF 50V COG+5%		0.0300	0.0137	0.0098	0.0094	0.0085
C0805 15pF 50V COG	15pF 50V COG+5%		0.0300	0.0137	0.0098	0.0094	0.0085
C0805 15pF 50V U2J	15pF 50V U2J+5%		0.0410	0.0186	0.0133	0.0128	0.0116
C0805 18pF 50V COG	18pF 50V COG+5%		0.0300	0.0137	0.0098	0.0094	0.0085
C0805 18pF 50V U2J	18pF 50V U2J+5%		0.0410	0.0186	0.0133	0.0128	0.0116
C0805 20pF 50V COG	20pF 50V COG+5%		0.0300	0.0137	0.0098	0.0094	0.0085
C0805 22pF 50V COG	22pF 50V COG+5%		0.0300	0.0137	0.0098	0.0094	0.0085
C0805 22pF 50V U2J	22pF 50V U2J+5%		0.0410	0.0186	0.0133	0.0128	0.0116
C0805 24pF 50V COG	24pF 50V COG+5%		0.0300	0.0137	0.0098	0.0094	0.0085
C0805 27pF 50V COG	27pF 50V COG+5%		0.0300	0.0137	0.0098	0.0094	0.0085
C0805 27pF 50V U2J	27pF 50V U2J+5%		0.0410	0.0186	0.0133	0.0128	0.0116
C0805 33pF 50V COG	33pF 50V COG+5%		0.0300	0.0137	0.0098	0.0094	0.0085

Ceramic Capacitors SMD 0805 MCH21 ROHM			1-9	10-99	100-999	1000+	5000+
C0805 33pF 50V U2J	33pF 50V U2J+-5%	0.0410	0.0186	0.0133	0.0128	0.0116	
C0805 39pF 50V C0G	39pF 50V C0G+-5%	0.0300	0.0137	0.0098	0.0094	0.0085	
C0805 47pF 50V C0G	47pF 50V C0G+-5%	0.0300	0.0137	0.0098	0.0094	0.0085	
C0805 51pF 50V C0G	51pF 50V C0G+-5%	0.0300	0.0137	0.0098	0.0094	0.0085	
C0805 56pF 50V C0G	56pF 50V C0G+-5%	0.0360	0.0165	0.0119	0.0113	0.0103	
C0805 62pF 50V C0G	62pF 50V C0G+-5%	0.0300	0.0137	0.0098	0.0094	0.0085	
C0805 68pF 50V C0G	68pF 50V C0G+-5%	0.0300	0.0137	0.0098	0.0094	0.0085	
C0805 75pF 50V C0G	75pF 50V C0G+-5%	0.0300	0.0137	0.0098	0.0094	0.0085	
C0805 82pF 50V C0G	82pF 50V C0G+-5%	0.0300	0.0137	0.0098	0.0094	0.0085	
C0805 91pF 50V C0G	91pF 50V C0G+-5%	0.0320	0.0147	0.0106	0.0101	0.0092	
C0805 100pF 50V C0G	100pF 50V C0G+-5%	0.0420	0.0193	0.0139	0.0133	0.0121	
C0805 100pF 50V C0G	100pF 50V C0G+-10%	0.0300	0.0137	0.0098	0.0094	0.0085	
C0805 120pF 50V C0G	120pF 50V C0G+-5%	0.0310	0.0140	0.0101	0.0096	0.0088	
C0805 130pF 50V C0G	130pF 50V C0G+-5%	0.0480	0.0221	0.0159	0.0152	0.0138	
C0805 150pF 50V C0G	150pF 50V C0G+-5%	0.0300	0.0137	0.0098	0.0094	0.0085	
C0805 160pF 50V C0G	160pF 50V C0G+-5%	0.0450	0.0206	0.0148	0.0141	0.0129	
C0805 180pF 50V C0G	180pF 50V C0G+-5%	0.0310	0.0140	0.0101	0.0096	0.0088	
C0805 200pF 50V C0G	200pF 50V C0G+-5%	0.0490	0.0223	0.0160	0.0153	0.0139	
C0805 220pF 50V C0G	220pF 50V C0G+-5%	0.0490	0.0223	0.0161	0.0154	0.0140	
C0805 240pF 50V C0G	240pF 50V C0G+-5%	0.0540	0.0245	0.0176	0.0168	0.0153	
C0805 270pF 50V C0G	270pF 50V C0G+-5%	0.0320	0.0148	0.0107	0.0102	0.0093	
C0805 330pF 50V C0G	330pF 50V C0G+-5%	0.0330	0.0152	0.0109	0.0104	0.0095	
C0805 330pF 50V X7R	330pF 50V X7R+-10%	0.0310	0.0140	0.0101	0.0096	0.0088	
C0805 390pF 50V C0G	390pF 50V C0G+-5%	0.0360	0.0165	0.0119	0.0114	0.0103	
C0805 470pF 50V C0G	470pF 50V C0G+-5%	0.0440	0.0202	0.0145	0.0139	0.0127	
C0805 560pF 50V C0G	560pF 50V C0G+-5%	0.0520	0.0240	0.0172	0.0165	0.0150	
C0805 560pF 50V X7R	560pF 50V X7R+-10%	0.0310	0.0140	0.0101	0.0096	0.0088	
C0805 680pF 50V C0G	680pF 50V C0G+-5%	0.0620	0.0282	0.0202	0.0194	0.0176	
C0805 680pF 50V X7R	680pF 50V X7R+-10%	0.0310	0.0140	0.0101	0.0096	0.0088	
C0805 820pF 50V C0G	820pF 50V C0G+-5%	0.0690	0.0314	0.0226	0.0216	0.0196	
C0805 820pF 50V X7R	820pF 50V X7R+-10%	0.0310	0.0140	0.0101	0.0096	0.0088	
C0805 1.0nF 50V C0G	1.0nF 50V C0G+-5%	0.0660	0.0302	0.0217	0.0208	0.0189	
C0805 1.0nF 50V C0G	1.0nF 50V C0G+-10%	0.0620	0.0282	0.0202	0.0194	0.0176	
C0805 1.0nF 50V X7R	1.0nF 50V X7R+-10%	0.0320	0.0148	0.0107	0.0102	0.0093	
C0805 1.2nF 50V C0G	1.2nF 50V C0G+-5%	0.0760	0.0349	0.0251	0.0240	0.0218	
C0805 1.2nF 50V X7R	1.2nF 50V X7R+-10%	0.0330	0.0152	0.0109	0.0104	0.0095	
C0805 1.5nF 50V X7R	1.5nF 50V X7R+-10%	0.0310	0.0140	0.0101	0.0096	0.0088	
C0805 1.8nF 50V X7R	1.8nF 50V X7R+-10%	0.0330	0.0152	0.0109	0.0104	0.0095	
C0805 2.2nF 50V X7R	2.2nF 50V X7R+-10%	0.0320	0.0146	0.0105	0.0100	0.0091	
C0805 2.7nF 50V X7R	2.7nF 50V X7R+-10%	0.0330	0.0152	0.0109	0.0104	0.0095	
C0805 3.3nF 50V X7R	3.3nF 50V X7R+-10%	0.0310	0.0140	0.0101	0.0096	0.0088	
C0805 3.9nF 50V X7R	3.9nF 50V X7R+-10%	0.0330	0.0152	0.0109	0.0104	0.0095	
C0805 4.7nF 50V X7R	4.7nF 50V X7R+-10%	0.0330	0.0151	0.0108	0.0104	0.0094	
C0805 5.6nF 50V X7R	5.6nF 50V X7R+-10%	0.0330	0.0152	0.0109	0.0104	0.0095	
C0805 6.8nF 50V X7R	6.8nF 50V X7R+-10%	0.0310	0.0140	0.0101	0.0096	0.0088	
C0805 8.2nF 50V X7R	8.2nF 50V X7R+-10%	0.0330	0.0152	0.0109	0.0104	0.0095	
C0805 10nF 50V X7R	10nF 50V X7R+-5%	0.0300	0.0138	0.0099	0.0095	0.0086	
C0805 10nF 50V X7R	10nF 50V X7R+-10%	0.0320	0.0146	0.0105	0.0100	0.0091	
C0805 10nF 50V X7R	10nF 50V X7R+-20%	0.0300	0.0138	0.0099	0.0095	0.0086	
C0805 10nF 50V Y5V	10nF 50V Y5V+-80-20%	0.0300	0.0138	0.0099	0.0095	0.0086	
C0805 12nF 50V X7R	12nF 50V X7R+-10%	0.0390	0.0179	0.0129	0.0123	0.0112	
C0805 15nF 50V X7R	15nF 50V X7R+-10%	0.0330	0.0150	0.0108	0.0103	0.0094	
C0805 18nF 50V X7R	18nF 50V X7R+-10%	0.0420	0.0192	0.0138	0.0132	0.0120	
C0805 22nF 50V X7R	22nF 50V X7R+-10%	0.0340	0.0155	0.0111	0.0107	0.0097	
C0805 22nF 50V Y5V	22nF 50V Y5V+-80-20%	0.0310	0.0140	0.0101	0.0096	0.0088	
C0805 27nF 50V X7R	27nF 50V X7R+-10%	0.0420	0.0192	0.0138	0.0132	0.0120	
C0805 33nF 25V X7R	33nF 25V X7R+-10%	0.0590	0.0272	0.0195	0.0187	0.0170	
C0805 33nF 50V X7R	33nF 50V X7R+-10%	0.0660	0.0302	0.0217	0.0208	0.0189	
C0805 33nF 50V Y5V	33nF 50V Y5V+-80-20%	0.0560	0.0257	0.0185	0.0177	0.0161	
C0805 39nF 50V X7R	39nF 50V X7R+-10%	0.0750	0.0344	0.0247	0.0237	0.0215	
C0805 47nF 25V X7R	47nF 25V X7R+-10%	0.0590	0.0272	0.0195	0.0187	0.0170	
C0805 47nF 50V X7R	47nF 50V X7R+-10%	0.0370	0.0168	0.0121	0.0116	0.0105	
C0805 47nF 50V Y5V	47nF 50V Y5V+-80-20%	0.0320	0.0147	0.0105	0.0101	0.0092	
C0805 56nF 25V X7R	56nF 25V X7R+-10%	0.1040	0.0477	0.0343	0.0328	0.0298	
C0805 68nF 25V X7R	68nF 25V X7R+-10%	0.0730	0.0332	0.0239	0.0228	0.0208	
C0805 68nF 50V Y5V	68nF 50V Y5V+-80-20%	0.0660	0.0302	0.0217	0.0208	0.0189	
C0805 82nF 25V X7R	82nF 25V X7R+-10%	0.0850	0.0389	0.0280	0.0268	0.0243	
C0805 100nF 25V X7R	100nF 25V X7R+-10%	0.0870	0.0398	0.0286	0.0274	0.0249	

Ceramic Capacitors SMD 0805 MCH21 ROHM			1-9	10-99	100-999	1000+	5000+
C0805 100nF 25V Y5V	100nF 25V Y5V+80-20%	0.0340	0.0153	0.0110	0.0106	0.0096	
C0805 100nF 50V X7R	100nF 50V X7R+10%	0.0500	0.0230	0.0165	0.0158	0.0144	
C0805 100nF 50V Y5V	100nF 50V Y5V+80-20%	0.0390	0.0176	0.0127	0.0121	0.0110	
C0805 150nF 25V X7R	150nF 25V X7R+10%	0.1440	0.0660	0.0474	0.0453	0.0412	
C0805 220nF 16V X7R	220nF 16V X7R+10%	0.1560	0.0714	0.0513	0.0491	0.0446	
C0805 220nF 25V Y5V	220nF 25V Y5V+80-20%	0.0450	0.0207	0.0149	0.0143	0.0130	
C0805 220nF 50V Y5V	220nF 50V Y5V+80-20%	0.0780	0.0358	0.0257	0.0246	0.0223	
C0805 330nF 25V Y5V	330nF 25V Y5V+80-20%	0.1270	0.0582	0.0418	0.0400	0.0364	
C0805 470nF 25V Y5V	470nF 25V Y5V+80-20%	0.0730	0.0334	0.0240	0.0230	0.0209	
C0805 1uF 16V Y5V	1uF 16V Y5V+80-20%	0.0980	0.0447	0.0321	0.0307	0.0279	
Ceramic Capacitors SMD 1206 MCH31 ROHM			1-9	10-99	100-999	1000+	5000+
C1206 1.0pF 50V C0G	1.0pF 50V C0G+-0.25pF	0.0590	0.0270	0.0194	0.0185	0.0169	
C1206 1.5pF 50V C0G	1.5pF 50V C0G+-0.25pF	0.0590	0.0270	0.0194	0.0185	0.0169	
C1206 2.2pF 50V C0G	2.2pF 50V C0G+-0.25pF	0.0590	0.0270	0.0194	0.0185	0.0169	
C1206 3.3pF 50V C0G	3.3pF 50V C0G+-0.25pF	0.0590	0.0270	0.0194	0.0185	0.0169	
C1206 4.7pF 50V C0G	4.7pF 50V C0G+-0.25pF	0.0590	0.0270	0.0194	0.0185	0.0169	
C1206 6.8pF 50V C0G	6.8pF 50V C0G+-0.5pF	0.0580	0.0265	0.0190	0.0182	0.0165	
C1206 10pF 50V C0G	10pF 50V C0G+-0.5pF	0.0820	0.0374	0.0269	0.0257	0.0234	
C1206 12pF 50V C0G	12pF 50V C0G+-5%	0.0630	0.0288	0.0207	0.0198	0.0180	
C1206 15pF 50V C0G	15pF 50V C0G+-5%	0.0630	0.0288	0.0207	0.0198	0.0180	
C1206 18pF 50V C0G	18pF 50V C0G+-5%	0.0630	0.0288	0.0207	0.0198	0.0180	
C1206 22pF 50V C0G	22pF 50V C0G+-5%	0.0760	0.0348	0.0250	0.0239	0.0218	
C1206 27pF 50V C0G	27pF 50V C0G+-5%	0.0630	0.0288	0.0207	0.0198	0.0180	
C1206 33pF 50V C0G	33pF 50V C0G+-5%	0.0730	0.0332	0.0239	0.0228	0.0208	
C1206 47pF 50V C0G	47pF 50V C0G+-5%	0.0840	0.0384	0.0276	0.0264	0.0240	
C1206 56pF 50V C0G	56pF 50V C0G+-5%	0.0580	0.0265	0.0190	0.0182	0.0165	
C1206 68pF 50V C0G	68pF 50V C0G+-5%	0.0650	0.0299	0.0215	0.0206	0.0187	
C1206 82pF 50V C0G	82pF 50V C0G+-5%	0.0710	0.0322	0.0232	0.0222	0.0201	
C1206 100pF 50V C0G	100pF 50V C0G+-5%	0.0710	0.0322	0.0232	0.0222	0.0201	
C1206 150pF 50V C0G	150pF 50V C0G+-5%	0.0710	0.0322	0.0232	0.0222	0.0201	
C1206 220pF 50V C0G	220pF 50V C0G+-5%	0.0820	0.0375	0.0270	0.0258	0.0234	
C1206 220pF 50V X7R	220pF 50V X7R+-10%	0.0540	0.0245	0.0176	0.0168	0.0153	
C1206 270pF 50V C0G	270pF 50V C0G+-5%	0.0840	0.0385	0.0277	0.0265	0.0241	
C1206 330pF 50V C0G	330pF 50V C0G+-5%	0.0910	0.0418	0.0300	0.0287	0.0261	
C1206 330pF 50V X7R	330pF 50V X7R+-10%	0.0540	0.0245	0.0176	0.0168	0.0153	
C1206 470pF 50V C0G	470pF 50V C0G+-5%	0.1020	0.0467	0.0336	0.0321	0.0292	
C1206 470pF 50V X7R	470pF 50V X7R+-10%	0.0540	0.0245	0.0176	0.0168	0.0153	
C1206 560pF 50V C0G	560pF 50V C0G+-5%	0.1100	0.0502	0.0361	0.0345	0.0314	
C1206 560pF 50V X7R	560pF 50V X7R+-10%	0.0540	0.0245	0.0176	0.0168	0.0153	
C1206 680pF 50V C0G	680pF 50V C0G+-5%	0.1100	0.0502	0.0361	0.0345	0.0314	
C1206 680pF 50V X7R	680pF 50V X7R+-10%	0.0540	0.0245	0.0176	0.0168	0.0153	
C1206 820pF 50V C0G	820pF 50V C0G+-5%	0.1180	0.0538	0.0387	0.0370	0.0336	
C1206 820pF 50V X7R	820pF 50V X7R+-10%	0.0540	0.0245	0.0176	0.0168	0.0153	
C1206 1.0nF 50V C0G	1.0nF 50V C0G+-5%	0.1180	0.0538	0.0387	0.0370	0.0336	
C1206 1.0nF 50V X7R	1.0nF 50V X7R+-10%	0.0560	0.0255	0.0183	0.0175	0.0159	
C1206 1.5nF 50V X7R	1.5nF 50V X7R+-10%	0.0540	0.0245	0.0176	0.0168	0.0153	
C1206 2.2nF 50V X7R	2.2nF 50V X7R+-10%	0.0580	0.0265	0.0190	0.0182	0.0165	
C1206 3.3nF 50V X7R	3.3nF 50V X7R+-10%	0.0580	0.0265	0.0190	0.0182	0.0165	
C1206 4.7nF 50V X7R	4.7nF 50V X7R+-10%	0.0660	0.0302	0.0217	0.0207	0.0189	
C1206 6.8nF 50V X7R	6.8nF 50V X7R+-10%	0.0620	0.0281	0.0202	0.0193	0.0176	
C1206 10nF 50V X7R	10nF 50V X7R+-10%	0.0680	0.0312	0.0225	0.0215	0.0195	
C1206 15nF 50V X7R	15nF 50V X7R+-10%	0.0700	0.0319	0.0229	0.0219	0.0199	
C1206 22nF 50V X7R	22nF 50V X7R+-10%	0.0720	0.0331	0.0238	0.0227	0.0207	
C1206 33nF 50V X7R	33nF 50V X7R+-10%	0.1050	0.0479	0.0344	0.0329	0.0299	
C1206 47nF 50V X7R	47nF 50V X7R+-10%	0.1050	0.0479	0.0344	0.0329	0.0299	
C1206 47nF 50V Y5V	47nF 50V Y5V+80-20%	0.0870	0.0398	0.0286	0.0274	0.0249	
C1206 68nF 50V X7R	68nF 50V X7R+-10%	0.0920	0.0419	0.0301	0.0288	0.0262	
C1206 100nF 25V X7R	100nF 25V X7R+-10%	0.0660	0.0300	0.0215	0.0206	0.0187	
C1206 100nF 50V X7R	100nF 50V X7R+-10%	0.0900	0.0411	0.0296	0.0283	0.0257	
C1206 100nF 50V Y5V	100nF 50V Y5V+80-20%	0.0900	0.0411	0.0296	0.0283	0.0257	
C1206 150nF 50V Y5V	150nF 50V Y5V+80-20%	0.2130	0.0974	0.0700	0.0669	0.0609	
C1206 220nF 25V X7R	220nF 25V X7R+-10%	0.1210	0.0554	0.0398	0.0381	0.0346	
C1206 220nF 50V Y5V	220nF 50V Y5V+80-20%	0.2130	0.0974	0.0700	0.0669	0.0609	
C1206 330nF 50V Y5V	330nF 50V Y5V+80-20%	0.1740	0.0798	0.0573	0.0548	0.0499	
C1206 470nF 25V Y5V	470nF 25V Y5V+80-20%	0.1900	0.0870	0.0625	0.0598	0.0544	

Ceramic Capacitors SMD 1206 MCH31 ROHM

		1-9	10-99	100-999	1000+	5000+	
C1206	470nF 50V Y5V	470nF 50V Y5V+80-20%	0.2170	0.0993	0.0714	0.0683	0.0621
C1206	1uF 25V Y5V	1uF 25V Y5V+80-20%	0.1910	0.0873	0.0628	0.0600	0.0546
C1206	1.5uF 25V Y5V	1.5uF 25V Y5V+80-20%	0.2500	0.1145	0.0823	0.0787	0.0715
C1206	2.2uF 16V Y5V	2.2uF 16V Y5V+80-20%	0.2500	0.1145	0.0823	0.0787	0.0715

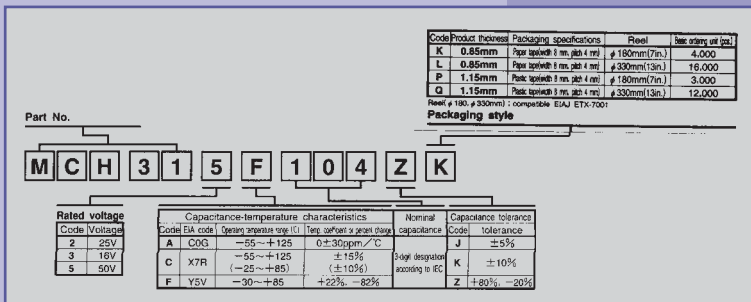

Tantalum Capacitors SMD

		1-9	10-99	100-999	1000+	5000+	
TANT A SMD	1uF 20V	1.0uF 20V 20% A (1206) 0.5uA ESR 10 Ohm	0.3300	0.1511	0.1086	0.1039	0.0944
TANT A SMD	1uF 25V	1.0uF 25V 10% A (1206) 0.5uA ESR(100kHz) 8 Ohm	0.1250	0.1000	0.0914	0.0844	0.0781
TANT A SMD	2.2uF 16V	2.2uF 16V 20% A (1206) 0.5uA ESR 7 Ohm	0.3400	0.1555	0.1118	0.1069	0.0972
TANT B SMD	4.7uF 16V	4.7uF 16V 20% B 0.8uA ESR 3.5 Ohm	0.1630	0.1306	0.1194	0.1102	0.1020
TANT B SMD	10uF 16V	10.0uF 16V 10% B 1.6uA ESR(100kHz) 2.8 Ohm	0.1820	0.1455	0.1330	0.1228	0.1137
TANT B SMD	15uF 10V	15.0uF 10V 20% B 1.5uA ESR 2.5 Ohm	0.4610	0.2107	0.1515	0.1449	0.1317
TANT A SMD	1uF 35V	1.0uF 35V 10% A 0.5uA ESR 8 Ohm	0.2380	0.1906	0.1742	0.1608	0.1489
TANT B SMD	2.2uF 35V	2.2uF 35V 10% B 0.77uA ESR 4.2 Ohm	0.2780	0.2224	0.2033	0.1876	0.1737
TANT B SMD	22uF 16V	22uF 16V 10% B 3.52uA ESR 2.5 Ohm	0.3770	0.3018	0.2759	0.2546	0.2358
TANT B SMD	47uF 6.3V	47uF 6.3V 10% B 2.96uA ESR 2.0 Ohm	0.3770	0.3018	0.2759	0.2546	0.2358

Zener Diodes 500mV MINI-MELF BZV

		1-9	10-99	100-999	1000+	5000+
BZV55C3V0	500 mW 5% 3V	0.0250	0.0190	0.0180	0.0170	0.0154
BZV55C3V3	500 mW 5% 3.3V	0.0260	0.0200	0.0190	0.0180	0.0158
BZV55C3V6	500 mW 5% 3.6V	0.0250	0.0190	0.0180	0.0170	0.0154
BZV55C3V9	500 mW 5% 3.9V	0.0260	0.0200	0.0190	0.0180	0.0158
BZV55C4V3	500 mW 5% 4.3V	0.0260	0.0200	0.0190	0.0180	0.0158
BZV55C4V7	500 mW 5% 4.7V	0.0260	0.0200	0.0190	0.0180	0.0158
BZV55C5V1	500 mW 5% 5.1V	0.0260	0.0200	0.0190	0.0180	0.0158
BZV55C5V6	500 mW 5% 5.6V	0.0260	0.0200	0.0190	0.0180	0.0158
BZV55C6V2	500 mW 5% 6.2V	0.0260	0.0200	0.0190	0.0180	0.0160
BZV55C6V8	500 mW 5% 6.8V	0.0260	0.0200	0.0190	0.0180	0.0158
BZV55C7V5	500 mW 5% 7.5V	0.0260	0.0200	0.0190	0.0180	0.0158
BZV55C8V2	500 mW 5% 8.2V	0.0260	0.0200	0.0190	0.0180	0.0158
BZV55C9V1	500 mW 5% 9.1V	0.0260	0.0200	0.0190	0.0180	0.0158
BZV55C10	500 mW 5% 10V	0.0300	0.0230	0.0220	0.0210	0.0183
BZV55C12	500 mW 5% 12V	0.0260	0.0200	0.0190	0.0180	0.0158
BZV55C13	500 mW 5% 13V	0.0250	0.0190	0.0180	0.0170	0.0154
BZV55C15	500 mW 5% 15V	0.0290	0.0220	0.0220	0.0200	0.0180
BZV55C18	500 mW 5% 18V	0.0260	0.0200	0.0190	0.0180	0.0158
BZV55C20	500 mW 5% 20V	0.0260	0.0200	0.0190	0.0180	0.0158
BZV55C24	500 mW 5% 24V	0.0300	0.0220	0.0220	0.0200	0.0181
BZV55C27	500 mW 5% 27V	0.0260	0.0200	0.0190	0.0180	0.0158
BZV55C30	500 mW 5% 30V	0.0260	0.0200	0.0190	0.0180	0.0158
BZV55C39	500 mW 5% 39V	0.0250	0.0190	0.0180	0.0170	0.0154
BZV55C47	500 mW 5% 47V	0.0260	0.0200	0.0190	0.0180	0.0162
BZV55C75	500 mW 5% 75V	0.0250	0.0190	0.0180	0.0170	0.0154

Zener Diodes 200mV SMD SOD-323 ROHM

		1-9	10-99	100-499	500+	
ZD3.9V	0.2W ROHM SMD	3.9V 200mV SOD-323	0.0570	0.0474	0.0443	0.0392
ZD4.7V	0.2W ROHM SMD	4.7V 200mV SOD-323	0.0570	0.0474	0.0443	0.0392
ZD5.1V	0.2W ROHM SMD	5.1V 200mV SOD-323	0.0570	0.0477	0.0447	0.0395
ZD5.6V	0.2W ROHM SMD	5.6V 200mV SOD-323	0.0570	0.0477	0.0447	0.0395
ZD6.2V	0.2W ROHM SMD	6.2V 200mV SOD-323	0.0570	0.0477	0.0447	0.0395

Zener Diodes 200mV SMD SOD-323 ROHM		1-9	10-99	100-499	500+	
ZD6.8V 0.2W ROHM SMD	6.8V 200mV SOD-323	0.0570	0.0477	0.0447	0.0395	
ZD8.2V 0.2W ROHM SMD	8.2V 200mV SOD-323	0.0570	0.0477	0.0447	0.0395	
ZD12V 0.2W ROHM SMD	12V 200mV SOD-323	0.0590	0.0491	0.0459	0.0406	
ZD15V 0.2W ROHM SMD	15V 200mV SOD-323	0.0560	0.0467	0.0437	0.0386	
ZD24V 0.2W ROHM SMD	24V 200mV SOD-323	0.0560	0.0467	0.0437	0.0386	
Transistors SMD		1-9	10-99	100-499	500-2999	3000+
BC807-25 ROHM SMD	SOT23 PNP 45V 0.8A 0.2W HFE 160-400	0.059	0.041	0.038	0.035	0.033
BC807-40 SMD	SOT23 PNP 45V 0.5A 0.25W HFE 250-600	0.034	0.024	0.022	0.021	0.019
BC817-25 ROHM SMD	SOT23 NPN 45V 0.8A 0.2W HFE 160-400					
BC817-40 SMD	SOT23 NPN 45V 0.5A 0.25W HFE 250-600	0.037	0.026	0.024	0.022	0.021
BC846B SMD	SOT23 NPN 80/65V 0.1A 0.25W HFE min200	0.027	0.019	0.018	0.016	0.015
BC847B ROHM SMD	SOT23 NPN 50/45V 0.1A 0.35W HFE 200-450	0.042	0.030	0.028	0.025	0.024
BC847C SMD	SOT23 NPN 50/45V 0.1A 0.25W HFE 420-800	0.029	0.021	0.019	0.018	0.016
BC847C ROHM SMD	SOT23 NPN 50/45V 0.1A 0.35W HFE 400-800	0.042	0.030	0.028	0.025	0.024
BC856B SMD	SOT23 PNP 80/65V 0.1A 0.25W HFEmin200	0.033	0.023	0.022	0.020	0.019
BC857B ROHM SMD	SOT23 PNP 50/45V 0.1A 0.35W HFE 210-480	0.039	0.027	0.025	0.023	0.022
BC857C SMD	SOT23 PNP 50/45V 0.1A 0.35W HFE 420-800	0.027	0.019	0.018	0.016	0.015
MMBT5401	SOT23 PNP 160/150V 0.6A 0.35W HFE 60-240	0.085	0.059	0.055	0.051	0.047
BCX53-16T ROHM SMD	SOT89 PNP 100/80V 1A 1W HFE 100-250	0.139	0.125	0.115	0.107	0.099
BCX53-16	SOT89 PNP 100/80V 1A 1W HFE 100-250	0.128	0.116	0.106	0.099	0.092
BCX56-16TA ZETEX SMD	SOT89 NPN 100/80V 1A 1W HFE 100-250	0.149	0.134	0.123	0.115	0.106
BCX56-16TA ROHM SMD	SOT89 NPN 80V 1A 0.5W HFE 100-250	0.134	0.121	0.111	0.104	0.096
BCW30 ROHM SMD	SOT23 PNP 32V 0.1A 0.2W	0.047	0.033	0.030	0.028	0.026
BCW30 SMD	SOT23 PNP 32V 0.1A 0.25W	0.041	0.028	0.026	0.024	0.023
BCW32 ROHM SMD	SOT23 NPN 32V 0.1A 0.2W	0.048	0.034	0.031	0.029	0.027
FZT605TA	SOT223 NPN DARL140/120V 1.5A 2W HFE 2K	0.299	0.269	0.248	0.231	0.214
FZT790A	SOT223 NPN 60/50V 3A 2W HFE 300-800	0.346	0.311	0.286	0.267	0.247
FZT690BTA	SOT223 NPN 45/45V 2A 1W HFE 500	0.337	0.304	0.279	0.260	0.241
FZT851	SOT223 NPN 150/60V 6A 3W HFE 100-300	0.462	0.416	0.383	0.356	0.330
FZT949	SOT223 PNP 50/30V 5.5A 3W HFE 100-300	0.474	0.427	0.393	0.366	0.339
FZT951	SOT223 PNP 100/60V 5A 3W HFE 100-300	0.474	0.427	0.393	0.366	0.339
2SA1037AK ROHM SMD	SC59 PNP 60/50V 0.15A 0.2W	0.033	0.030	0.027	0.025	0.024
2SD1918TRQ ROHM SMD	160/160V 1.5A 1(10)W 80MHz	0.284	0.256	0.236	0.219	0.203
2SD2212T100 ROHM SMD	SOT89 NPN 60V 2A 0.5W	0.232	0.209	0.192	0.179	0.165
2SC3837K ROHM SMD	SC59 NPN 30/18V 50mA 0.2W 1.5GHz 4.5dB	0.069	0.062	0.057	0.053	0.049
2SC3838K ROHM SMD	SC59 NPN 20/11V 50mA 0.2W 3.2GHz 3.5dB	0.082	0.074	0.068	0.063	0.059
2SC2412K ROHM SMD	SC59 NPN 60/50V 0.15A 0.2W	0.030	0.027	0.025	0.023	0.021
2SK2504 ROHM SMD	SC63 N 100V 5A	0.298	0.259	0.241	0.229	0.000
MMBT2907A	SOT23 PNP 60/60V 0.6A 0.225W 45/100nS	0.036	0.032	0.030	0.027	0.025
SST2907A ROHM SMD R2F	SOT23 PNP 60/60V 0.6A 0.2W 50/100nS	0.036	0.032	0.030	0.028	0.026
SST3906 ROHM SMD R2F	SOT23 PNP 60/40V 0.2A 0.2W 50/100nS	0.032	0.029	0.027	0.025	0.023
SST3904 ROHM SMD R2F	SOT23 PNP 60/60V 0.1A 0.2W 50/100nS	0.031	0.028	0.025	0.024	0.022
SST2222A ROHM SMD R1P	SOT23 NPN 75/40V 0.6A 0.35W 25/60nS	0.028	0.025	0.023	0.022	0.020
ZVN3310F ZETEX SMD	SOT23 NMOS 100V 0.1A 10 Ohm Ugs 0.8/2.4V	0.173	0.158	0.138	0.128	
ZVN4424G ZETEX SMD	SOT223 NMOS 240V 0.5A 6 Ohm Ugs 0.8/1.8V	0.647	0.589	0.517	0.479	
Digital Transistors ROHM		1-9	10-99	100-999	1000+	5000+
DTA114TKA ROHM SMD	DIGI TRANS Rin 10k PNP 50V 100mA	0.031	0.028	0.026	0.023	0.022
DTA114YKA ROHM SMD	DIGI TRANS Rin 10k Rbe 47k PNP 50V 70mA	0.031	0.028	0.026	0.023	0.022
DTC114TKA ROHM SMD	DIGI TRANS Rin 10k NPN 50V 100mA	0.031	0.028	0.026	0.023	0.022
DTC114YKA ROHM SMD	DIGI TRANS Rin 10k Rbe 47k NPN 50V 70mA	0.031	0.028	0.026	0.023	0.022
DTC124TKA ROHM SMD	DIGI TRANS Rin 22k NPN 50V 100mA	0.031	0.028	0.026	0.023	0.022
DTC143TKA ROHM SMD	DIGI TRANS Rin 4.7k NPN 50V 100mA	0.031	0.028	0.026	0.023	0.022
DTC144TKA ROHM SMD	DIGI TRANS Rin 47k NPN 50V 100mA	0.031	0.028	0.026	0.023	0.022

Transistors SMD

1-9 10-99 100-499 500-2999 3000+

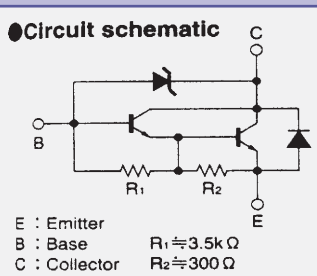
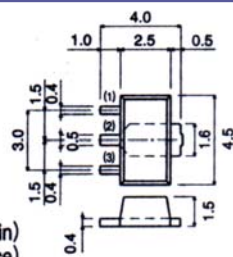
SMD Medium power NPN SMD transistor (motor, relay drive)
2SD2212MPT3
(SC-62)
<SOT-89>

- * built-in center diode between base and collector
- * built-in resistor between base and emitter
- * built-in damper diode
- * strong protection against reverse surges due to L loads

Characteristics

Parameter	Symbol	Value	Unit/Conditions
Collector base voltage	V_{CBO}	60+/-10	V
Collector emitter voltage	V_{CES}	60+/-10	V
Emitter base voltage	V_{EBO}	6	V
Collector current	I_C	2 3	A(DC) A(pulse)
Dissipated power by collector	P_C	2	W (ceramic substrate 40x40x0.7)
Junction temperature	T_j	150	°C
Storage temperature	T_{stg}	-55 - +150	°C
DC current transfer ratio	h_{FE}	1k-10k	V _{CE} =2V, I _C =1A
Breakdown voltage collector-base	BV_{CBO}	50-70	V(I _C =50μA)
Breakdown voltage collector-emitter	BV_{CEO}	50-70	V(I _C =5 mA)
Cut-off collector current	I_{CBO}	1.0	μA(V _{CE} =40V)
Cut-off emitter current	I_{EBO}	3	mA(V _{EB} =5V)
Saturation voltage collector-emitter	$V_{CE(sat)}$	1.5	V(I _C /I _B =1A/1mA)
Output capacitance	C_{ob}	25pF	V _{CB} =10V, f=1MHz

Diodes SMD

		1-9	10-99	100-999	1000+	5000+
BAV70 SMD	SOT23 75V 2x125mA 4ns 1.5pF 250mW	0.033	0.030	0.027	0.025	0.023
BAV99T ROHM SMD	SOT23 80V 2X100mA 4ns 3.5 pF 200mW	0.048	0.043	0.040	0.037	0.034
BAS16 SMD	SOT23 75V 215mA 4ns 1.5pF 250mW	0.026	0.023	0.021	0.020	0.018
1N4148 SMD	SOD-80C(mini melf) 75V 200mA 4ns 4pF 500mW	0.015	0.013	0.012	0.011	0.011
1N4148 ROHM SMD	LL-34 75V	0.019	0.017	0.016	0.015	0.014
1N4006 SMD	Melf 800V 1A	0.055	0.050	0.046	0.042	0.039
1N4007 SMD	Melf 1000V 1A	0.050	0.045	0.041	0.038	0.035
G7 SMD	1000V 1A SM-A GLASS PASIVATED	0.053	0.048	0.044	0.041	0.038
F7 SMD	1000V 1A SM-A FAST 500nS GLASS PASIVATED	0.064	0.058	0.053	0.050	0.046

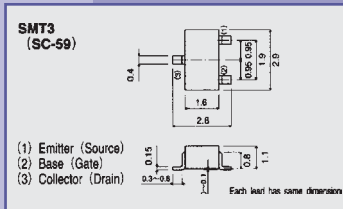
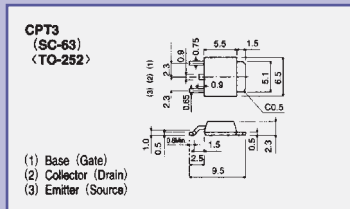
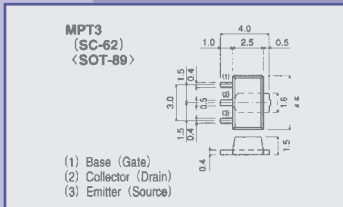
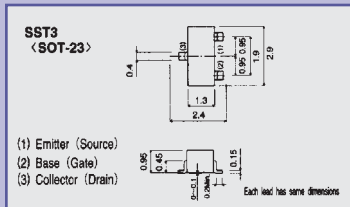

Operational Amplifiers

		1-24	25-99	100-499	500+
OP07CP	DIL8	0.322	0.300	0.280	0.248
TL061CN	DIL8	0.226	0.211	0.197	0.174
TL062CN	DIL8	0.208	0.194	0.181	0.160
TL064CN	DIL14	0.281	0.261	0.244	0.216
TL071CN	DIL8	0.261	0.243	0.227	0.201
TL072CN	DIL8	0.208	0.194	0.181	0.160
TL074CN	DIL14	0.281	0.261	0.244	0.216
TL081CN	DIL8	0.222	0.207	0.193	0.171
TL082CN	DIL8	0.212	0.198	0.185	0.163
TL084CN	DIL14	0.281	0.261	0.244	0.216
LM324N	DIP14 2mV,5na, 20nA,Iq 0.6mA,Vcc32V	0.133	0.123	0.111	0.098
LM324/BA10324A ROHM	DIP14 2mV,5na, 20nA,Iq 0.6mA,Vcc32V	0.259	0.240	0.217	0.192
LM348N	DIL14	0.531	0.495	0.462	0.409
LM349N	DIL14	1.156	1.076	1.005	0.889
LF355N	DIL8	1.323	1.232	1.150	1.018
LF356N	DIL8	0.572	0.533	0.498	0.440
LF357N	DIL8	0.583	0.543	0.507	0.449
LM358N	DIL8 2mV,5nA,45nA,Iq 1mA	0.129	0.120	0.108	0.096
LM358/BA10358 ROHM	DIP8 2mV,5nA,45nA,0.2V/uS,Iq 0.7mA	0.164	0.152	0.137	0.122

		1-4	5-24	25-99	100+
MCP601-I/P	DIL8 1 OA 2mV,1pA,2.7-5.5V,230uA,2.8MHz	0.502	0.456	0.409	0.386
MCP602-I/P	DIL8 2 OA 2mV,1pA,2.7-5.5V,230uA,2.8MHz	0.651	0.591	0.531	0.501
MCP603-I/P	DIL8 1 OA C/S 2mV,1pA,2.7-5.5V,230uA,2.8	0.521	0.472	0.424	0.400
MCP604-I/P	DIL8 4 OA 2mV,1pA,2.7-5.5V,230uA,2.8MHz	1.190	1.080	0.970	0.915
MCP606-I/P	DIL8 1 OA 0.2mV,1pA,2.7-5.5V,25uA,155kHz	0.744	0.675	0.606	0.572
MCP607-I/P	DIL8 2 OA 0.2mV,1pA,2.7-5.5V,25uA,155kHz	0.985	0.894	0.803	0.758
MCP608-I/P	DIL8 1 OA C/S 0.2mV,1pA,2.7-5.5V,25uA	0.799	0.726	0.652	0.615
MCP609-I/P	DIL8 4 OA 0.2mV,1pA,2.7-5.5V,25uA,155kHz	1.487	1.350	1.213	1.144

Operational Amplifiers		1-24	25-99	100-499	500+
UA741CN	DIL8	0.139	0.128	0.116	0.103
UA1458CN	DIL8	0.156	0.145	0.131	0.116
LM2902N	DIL14 4 Op Amps~LM324 -40+85 C	0.147	0.136	0.123	0.109
LM2904N	DIL8 2 Op Amps~LM358 -40+85 C	0.147	0.136	0.123	0.109
CA3054	DIL8	0.157	0.139	0.120	
CA3130E	DIL8	0.745	0.659	0.573	
CA3140E	DIL8	0.473	0.418	0.364	
NE5534	DIL8	0.297	0.275	0.249	0.220
ICL7650	DIL8	2.275	2.013	1.750	
Comparators		1-24	25-99	100-499	500+
LM311N	DIL8 4mV,20nA,150nA,Vcc 5V-36V	0.124	0.116	0.108	0.096
LM311H	TO9	0.468	0.436	0.407	0.360
LM339N	DIL14 4 Comp. ~ LM339 -40+85 C	0.160	0.149	0.139	0.123
LM339/BA10339 ROHM	DIP14				
LM393N	DIL8	0.125	0.116	0.108	0.096
LM393/BA393 ROHM	DIP9	0.123	0.115	0.107	0.095
LM2901N	DIL14 4 Comp. ~ LM339 -40+85 C	0.147	0.136	0.123	0.109
LM2903N	DIL8 2 Comp. ~ LM393 -40+85 C	0.147	0.136	0.123	0.109
Timers		1-24	25-99	100-499	500+
LMC555CN (7555)	CMOS TIMER=7555	0.265	0.235	0.210	0.196
NE555N	DIP8 TIMER	0.127	0.118	0.107	0.094
NE556N	DIP14 DUAL TIMER	0.218	0.194	0.173	0.162
NE558	QUAD TIMER	0.392	0.347	0.302	
Miscellaneous		1-24	25-99	100-499	500+
LM335Z	Temp. Sensor	0.771	0.714	0.645	0.571
NE564N	PLL	1.028	0.957	0.894	
NE565N	PLL	0.638	0.594	0.555	
LM567CN	Tone Decoder	0.264	0.245	0.229	
LM567 (DBL567 DAEWOO)	Tone Decoder	0.330	0.307	0.287	
LMC567CN	Tone Decoder CMOS				
MC33064-5	Reset 5V, threshold 4.6V-40+85 C				
ZM33064C	Reset 5V, threshold 4.6V-40+85 C	0.338	0.313	0.283	0.250
ZM33064G SMD	Reset 5V, threshold 4.6V-40+85 C SMD	0.442	0.409	0.370	0.327
ZM33164C	Reset 5V, threshold 4.6V-40+85 C	0.343	0.318	0.287	0.254
MC34064-5	Reset 5V, threshold 4.6V 0+70 C	0.635	0.588	0.531	0.470
MAX690CPA(ADM690)	Reset	3.649	3.228	2.807	
MAX691CPE(ADM691)	Reset	3.593	3.178	2.764	
TL7705ACP	Reset	0.353	0.312	0.272	
ICL8038CCPD	Function Generator	1.855	1.641	1.427	
MC13135P	FM Receiver, double conversion	1.548	1.369	1.190	
MC2831AP OBS	FM Transmitter for cordless telephone	1.548	1.369	1.190	
DS12C887	real time clock+quartz+RAM+,lithium batt.-10years	5.465	5.001	4.631	
DS1210	battery back up/RAM controller	3.213	2.941	2.723	
UAA2016P	Triac Control Circuit	1.101	1.013	0.881	
U217B	Triac Control Circuit	0.653	0.601	0.522	
SMT16030Z	Temp Sensor -45+130C TO92 pulse output	2.369	2.151	1.932	1.823
SMT16030M	Temp Sensor -45+130C TO18 pulse output	2.793	2.535	2.277	2.148
SMT16030T	Temp Sensor -45+130C TO220 pulse output	2.825	2.565	2.304	2.173
SMTH10	Humidity Sensor	7.831	7.244	6.853	6.526
SMTRH05	Humidity Sensor 300pF, 0.7pF/% RH	11.258	10.414	9.851	9.382
SMTUT103 DIP	DIL16 universal transducer interface	3.682	3.342	3.002	2.832
SMTUT103 SMD	SMD universal transducer interface	3.682	3.342	3.002	2.832
ZMC05	Current Sensor 5A 0.7 mOhm Visol 200V 100kHz	3.404	3.012	2.619	
ZMC10	Current Sensor 10A 0.7 mOhm Visol 2KV 100kHz	4.180	3.698	3.216	
ZMC20	Current Sensor 20A 0.7 mOhm Visol 2KV 100kHz	4.180	3.698	3.216	
ZMY20	magnetic sensor 12V 4(mV/V)/(kA/m) SMD	2.373	2.100	1.826	
ZMY20M	magn sensor with a magnet 12V 4(mV/V)/(kA/m)SMD	2.704	2.392	2.080	
ZMY30	magnetic sensor 15V 3(mV/V)/(kA/m) SMD	2.373	2.100	1.826	
ZM220	magnetic sensor 12V 4(mV/V)/(kA/m)		2.901	2.566	2.231

Receiver/Transmitter Modules		1-4	5-24	25-99	100+	
AM-HRR3-418	AM Hybrid Receiver Module 418 MHz	6.129	5.448	4.857	4.540	
AM-HRR3-433	AM Hybrid Receiver Module 433 MHz	6.129	5.448	4.857	4.540	
AM-HRR6-418	AM Hybrid Receiver Module 418 MHz 0.5 mA	6.270	5.573	4.970	4.644	
AM-HRR6-433	AM Hybrid Receiver Module 433 MHz 0.5 mA	6.270	5.573	4.970	4.644	
AM-RT4-418	AM Transmitter Module 418 MHz	5.123	4.554	4.061	3.795	
AM-RT4-433	AM Transmitter Module 433 MHz	5.123	4.554	4.061	3.795	
AM-TX1-418	AM Transmitter Module 418 MHz	7.877	7.001	6.243	5.835	
AM-TX1-433	AM Transmitter Module 433 MHz	7.877	7.001	6.243	5.835	
TX1-173-10-225K	Transmitter module	33.637	29.900	26.660	24.916	
FLEXI-4BA-418	Flexi 4BA 1/4 Wave Antenna 418 MHz	5.842	5.193	4.631	4.328	
FLEXI-4BA-433	Flexi 4BA 1/4 Wave Antenna 433 MHz	5.842	5.193	4.631	4.328	
FM-BiM-433FHP	FM Transceiver Module 433 MHz	53.045	50.677	48.782		
RX1-173-10-225K	Receiver	48.625	46.454	44.717		
FM-RX2-433F-5V	FM Receiver 433 MHz	33.730	32.225	31.020		
FM-RX2-418-40-3V	FM Receiver 418 MHz	20.997	20.060	19.310		
FM-RX2-433-160-3V	FM Receiver 433 MHz	20.997	20.060	19.310		
FM-RX2-433-40-3V	FM Receiver 433 MHz	20.997	20.060	19.310		
FM-RX3-869-64	FM Receiver 869 MHz	39.784	38.008	36.587		
SILRX-418-5	FM Receiver 418 MHz	19.892	19.004	18.293		
SILRX-433-5	FM Receiver 433 MHz	19.892	19.004	18.293		
FM-TX2-433-5V	FM Transmitter 433 MHz	16.609	15.867	15.274		
FM-TX2-433-160-3V	FM Transmitter 433 MHz	11.235	10.734	10.332		
FM-TX2-433-40-3V	FM Transmitter 433 MHz	11.235	10.734	10.332		
FM-TX2-418-40-3V	FM Transmitter 418 MHz	11.235	10.734	10.332		
FM-TX3A-869-64	FM Transmitter 869 MHz	20.223	19.321	18.598		
TXM-418-5	FM Transmitter 418 MHz	8.988	8.587	8.266		
TXM-433-5	FM Transmitter 433 MHz	8.988	8.587	8.266		
PU-4BA-418	Helical 4BA 1/4 Wave Antenna 418 Mhz	6.285	5.701	4.848	4.489	
PU-4BA-433	Helical 4BA 1/4 Wave Antenna 433 MHz	6.285	5.701	4.848	4.489	
RF1172RS	SAW Filter 433 MHz TO 39	3.681	3.256	3.115	2.831	
RF1172B	SAW Filter 433 MHz SMD	3.681	3.256	3.115	2.831	
RO2101RS	SAW Resonator 433 MHz TO 39	2.429	2.149	2.056	1.869	
RO2101A	SAW Resonator 433 MHz SMD	1.261	1.115	1.067	0.970	
RO2103A	SAW Resonator 418 MHz SMD	1.914	1.693	1.620	1.472	
Voltage references		1-4	5-24	25-99	100+	500+
LM336Z-5.0	5V 54 ppm/C	0.298	0.271	0.238	0.221	
LM385Z-1.2	1.2V 150 ppm/C	0.321	0.293	0.257	0.238	
LM385Z-2.5	2.5V 150 ppm/C	0.327	0.298	0.261	0.242	
TL431CLP	2.5V 50 ppm/C	0.146	0.131	0.121	0.113	0.104
ADC, S/H, V/F		1-24	25-99	100+	500+	
LM331N	VCO	1.523	1.394	1.291		
LF398N	S/H	1.102	1.009	0.934		
ICL7106	ADC 3 1/2 LCD 333 mS	1.722	1.531	1.365	1.276	
ICL7107	ADC 3 1/2 LED 333 mS	1.754	1.559	1.390	1.299	
ICL7109	ADC 12bits 133mS +/-5V 1.5mA	6.184	5.660	5.240		
ICL7135CPI	ADC 4 1/2(15bits) +/-5V 3mA BCD outp.	1.980	1.812	1.678		
MCP3201-BI/P	12 bit ADC, SPI, 1 ch 1LSB DNL 1LSB INL	2.912	2.636	2.510		
MCP3201-BI/SN SMD	12 bit ADC, SPI, 1 ch 1LSB DNL 1LSB INL	2.912	2.636	2.510		
MCP3201-CI/SN SMD	12 bit ADC, SPI, 1 ch 1LSB DNL 2LSB INL	2.322	2.102	2.002		
MCP3202-BI/P	12-bit ADC, SPI, dual channel	3.198	2.894	2.757		
MCP3208-BI/P	12-bit ADC, SPI, 8-channel	3.876	3.509	3.342		
MCP3001-I/P	10-bit ADC, SPI, single channel	1.715	1.552	1.478		
MCP3002-I/P	10-bit ADC, SPI, dual channel	1.804	1.633	1.555		
MCP3008-I/P	10-bit ADC, SPI, 8-channel	1.983	1.795	1.709		
DNL-Differential Nonlinearity INL-Integral Nonlinearity						
Interface Ics		1-24	25-99	100+	500+	
AM26LS31	RS422 transmitter	0.413	0.384	0.359	0.317	
AM26LS32	RS422 receiver	0.498	0.464	0.433	0.383	
MC1488P(SN75188)	RS232 transmitter	0.207	0.193	0.180	0.159	
MC1489P(SN75189)	RS232 receiver	0.207	0.193	0.180	0.159	
ICL232CPE	RS232 receiv/transmitter 5V	0.854	0.795	0.743	0.657	
MAX232N (ST232CN)	RS232 receiv/transmitter 5V	0.661	0.615	0.574	0.508	

Interface ICs		1-24	25-99	100+	500+
75107	2 receivers	0.430	0.397	0.336	
75115	2 dif. Receivers	0.595	0.548	0.465	
75118	dif. receiv/transmitter	0.769	0.709	0.601	
75150	RS232 transmitter	0.601	0.554	0.469	
75176	RS485/RS422 receiv/transmitter	0.453	0.402	0.359	0.335
Driver ICs		1-24	25-99	100+	500+
BA7604N ROHM	Video/audio signal switch	0.501	0.467	0.436	0.386
L293B	4 drivers 1A	2.110	1.964	1.834	1.623
ULN2003	7 dr.0.5A/50V Uin 2.4V	0.214	0.199	0.186	0.165
ULN2003/BA12003B ROHM	7 dr.0.5A/60V Uin 2.4V	0.288	0.268	0.250	0.221
ULN2004	7 dr.0.5A/50V Uin 5V	0.350	0.326	0.304	0.269
ULN2004/BA12004B ROHM	7 dr.0.5A/60V Uin 5V	0.343	0.319	0.298	0.264
ULN2803	8 dr.0.5A/50V Uin 2.4V	0.302	0.281	0.262	0.232
ULN2804	8 dr.0.5A/50V Uin 5V	0.302	0.281	0.262	0.232
75450	2 dr. AND input	0.206	0.190	0.161	
75452	NAND input 20V/0.3A	0.382	0.352	0.298	
75463	OR input 35V/0.4A	0.448	0.413	0.350	
75471	AND input 55V/0.3A	0.487	0.449	0.380	
75472	NAND input 55V/0.3A	0.487	0.449	0.380	
75477	AND input 70V/0.4A	0.414	0.381	0.323	
AY0438-1/P	LCD DRIVER 40LD	3.123	2.763	2.402	
BA6845FS ROHM	Motor Driver	1.421	1.323	1.235	1.093
Final Stage ICs		1-24	25-99	100+	500+
LM386N-1	325 mW	0.199	0.177	0.158	0.147
TBA820M	DIP8 2W /8 Ohm 16V 20 KHz	0.339	0.301	0.269	0.251
TDA2002V	10W	0.584	0.519	0.463	0.433
TDA2003V	10W	0.562	0.500	0.446	0.417
TDA2005M	2 x 10W	1.205	1.071	0.955	0.892
TDA2005R	2 x 10W	1.895	1.685	1.502	1.404
TDA2005S	2 x 10W	1.419	1.261	1.125	1.051
TDA2030V		0.877	0.779	0.695	0.649
Linear Voltage Regulators		1-24	25-99	100+	500+
LM317T	1.2-37V 1.5A TO220	0.257	0.234	0.206	0.190
LM317LZ	1.2-37V 100mA TO92	0.198	0.180	0.158	0.147
LM337T	-1.2-37V 1.5A TO220	0.461	0.407	0.354	
LM337LZ	-1.2-37V 100mA TO92	0.870	0.769	0.669	
uA723	2-37V 150mA	0.238	0.211	0.183	
BA033T ROHM	3.3V 1A,low Usat=0.3V TO220FP isolated	0.508	0.463	0.406	0.376
BA033ST ROHM	3.3V 1A,low Usat=0.3V TO220FP-5 isolated	0.580	0.529	0.464	0.430
7805	5V 1A TO-220	0.169	0.154	0.135	0.125
7805/BA17805T ROHM	5V 1A TO220FP isolated	0.311	0.283	0.249	0.230
BA05T ROHM	5V 1A,low Usat=0.3V TO220FP isolated	0.508	0.463	0.406	0.376
BA05ST ROHM	5V 1A,low Usat=0.3V TO220FP-5 isolated	0.580	0.529	0.464	0.430
7806	6V 1A TO-220	0.191	0.174	0.153	0.141
7808	8V 1A TO-220	0.192	0.175	0.153	0.142
7809	9V 1A TO-220	0.210	0.191	0.168	0.156
7810	10V 1A TO-220	0.286	0.261	0.229	0.212
7812	12V 1A TO-220	0.169	0.154	0.135	0.125
7812/BA17812T ROHM	12V 1A TO220FP isolated	0.311	0.283	0.249	0.230
7815	15V 1A TO-220	0.188	0.171	0.150	0.139
7815/BA17815T ROHM	15V 1A TO220FP isolated	0.311	0.283	0.249	0.230
7818	18V 1A TO-220	0.201	0.183	0.161	0.149
7824	24V 1A TO-220	0.195	0.177	0.156	0.144
7824/BA17824T ROHM	24V 1A TO220FP isolated	0.311	0.283	0.249	0.230
7905	-5V 1A TO-220	0.189	0.172	0.151	0.140
7906	-6V 1A TO-220	0.252	0.230	0.202	0.187
7908	-8V 1A TO-220	0.188	0.171	0.150	0.139
7912	-12V 1A TO-220	0.188	0.171	0.150	0.139
7915	-15V 1A TO-220	0.188	0.171	0.150	0.139
78L05	5V 100mA	0.144	0.122	0.112	0.106
78L05 ZETEX	5V +/- 2.5% 200mA 600mW -55+125C 0.1mV/C	0.174	0.148	0.135	0.129
78L06	6V 100mA	0.222	0.189	0.173	0.165
78L08	8V 100mA	0.142	0.121	0.110	0.105

Linear Voltage Regulators		1-24	25-99	100+	500+
78L09	9V 100mA	0.190	0.162	0.148	0.141
78L12	12V 100mA	0.155	0.132	0.120	0.115
78L15	15V 100mA	0.162	0.138	0.126	0.120
79L05	-5V 100mA	0.147	0.125	0.114	0.109
79L12	-12V 100mA	0.154	0.132	0.120	0.114
79L15	-15V 100mA	0.199	0.170	0.155	0.148
78S05	5V 2A	0.419	0.371	0.322	
78S12	12V 2A	0.419	0.371	0.322	
78S15	15V 2A	0.425	0.376	0.327	
78S24	24V 2A	0.463	0.409	0.356	
78T05	5V 3A 25W TO-220	0.522	0.445	0.401	
Pulse Voltage Regulators		1-24	25-99	100-499	500+
TL494	DIL14	0.256	0.230	0.214	0.190
TL494 UTC	DIP16	0.334	0.311	0.291	
LM2574N-5.0	DIL	0.853	0.794	0.741	
LM2575T-ADJ	TO220	1.208	1.124	1.050	
LM2575T-5.0	TO220	1.254	1.124	1.050	0.929
LM2576T-ADJ	TO220	1.531	1.411	1.196	
LM2576T-5.0	TO220	1.536	1.416	1.200	
LM3578AN	DIL8	1.261	1.162	0.985	
UC3842N	DIL	0.349	0.322	0.273	
UC3844N	DIL	0.441	0.402	0.353	0.327
MC34063AP1	DIL8	0.378	0.345	0.303	0.280
MC34063 SAMSUNG	DIL8	0.336	0.306	0.269	0.249
BP5020(BP5220) ROHM	DC/DC Hybrid In 8-38V Out 5V/1A	3.837	3.512	3.252	
BP5021(BP5221) ROHM	DC/DC Hybrid In 8-38V Out 5V/0.5A	3.355	3.070	2.843	
BP5022(BP5222) ROHM	DC/DC Hybrid In 15-38V Out 12V/0.5A	3.355	3.070	2.843	
BP5040 ROHM	DC/DC Hybrid In 224-358V Out 5V/0.1A	3.484	3.189	2.952	
BP5041 ROHM	DC/DC Hybrid In 224-358V Out 12V/0.1A	3.484	3.189	2.952	
EPROMs		1-24	25-99	100-499	500+
27C64-150	8k x 9	3.242	2.968	2.748	
27C128-150	16k x 9	2.111	1.932	1.789	
27C256-100/120	32k x 9	1.971	1.713	1.592	1.516
27C256-120 OTP	32k x 9	1.419	1.299	1.202	
27C512-100/120	64k x 9	2.224	1.933	1.796	1.711
27C010-100/120	128k x 9	3.023	2.776	2.478	
27C020-100/120	256k x 9	5.119	4.685	4.338	
27C040-100/120	512k x 9	5.437	4.976	4.607	
27C080-100/120	1024kx9	10.654	9.751	9.028	
EEPROMs		1-24	25-99	100-499	500+
28C16A-15/P	EEPROM 2K x 8	2.089	1.816	1.688	1.607
28C64B-15/PC	EEPROM 8K x 8	2.583	2.245	2.086	1.987
EEPROMs - ȦC BUS		1-24	25-99	100-499	500+
24C00/P MICROCHIP	128Bit, 16 X 8 SERIAL EE	0.262	0.231	0.218	0.210
24C01	EEPROM 1K, 128 X 8	0.257	0.226	0.214	0.205
24C02	EEPROM 2K	0.268	0.236	0.223	0.214
24C02 BR24C02-W ROHM	EEPROM 2K	0.324	0.285	0.269	0.259
24C04	EEPROM 4K	0.315	0.277	0.262	0.252
24C04 BR24C04-W ROHM	EEPROM 2K	0.406	0.357	0.338	0.325
24C08	EEPROM 8K	0.362	0.318	0.301	0.289
24C16	EEPROM 16K	0.496	0.437	0.413	0.397
24C32	EEPROM 32K	0.661	0.581	0.550	0.528
24C16B-E/P	EEPROM 32K	0.594	0.522	0.494	0.475
24C65/P	EEPROM 64K	1.519	1.337	1.264	1.215
24LC00-I/P	16 byte, 128 bit, 2.5V SEE	0.262	0.231	0.218	0.210
24LC00-I/SN SMD	16 byte, 128 bit, 2.5V SEE	0.262	0.231	0.218	0.210
24LC00T-I/OT SMD	16 byte, 128 bit, 2.5V SEE	0.262	0.231	0.218	0.210
24LC01B/P	1K, 128 X 8 2.5V SERIAL EE	0.297	0.261	0.247	0.237
24LC01B-I/P	1K, 128 X 8 2.5V SERIAL EE, IND	0.297	0.261	0.247	0.237

EEPROMs - I²C BUS		1-24	25-99	100-499	500+
24LC01B-I/SN SMD	1K, 128 X 8 2.5V SERIAL EE, IND	0.297	0.261	0.247	0.237
24LC01BT-I/OT SMD	2K, 256 X 8 2.5V SERIAL EE	0.279	0.246	0.232	0.224
24LC02B/P	2K, 256 X 8 2.5V SERIAL EE	0.314	0.277	0.262	0.251
24LC02B-I/P	2K, 256 X 8 2.5V SERIAL EE	0.314	0.277	0.262	0.251
24LC02B-I/SN SMD	2K, 256 X 8 2.5V SERIAL EE	0.314	0.277	0.262	0.251
24LC04B/P	4K, 512 X 8 2.5V SERIAL EE	0.384	0.338	0.320	0.307
24LC04B/SN SMD	4K, 512 X 8 2.5V SERIAL EE	0.384	0.338	0.320	0.307
24LC04B-I/SN SMD	4K, 512 X 8 2.5V SERIAL EE	0.384	0.338	0.320	0.307
24LC04B-I/P	4K, 512 X 8 2.5V SERIAL EE, IND	0.384	0.338	0.320	0.307
24LC08B/P	8K, 1K X 8 2.5V SERIAL EE	0.437	0.384	0.363	0.349
24LC08B-I/P	8K, 1K X 8 2.5V SERIAL EE, IND	0.437	0.384	0.363	0.349
24LC08B-I/SN SMD	8K, 1K X 8 2.5V SERIAL EE, IND	0.437	0.384	0.363	0.349
24LC16B/P	16K, 2K X 8 2.5V SERIAL EE	0.489	0.430	0.407	0.391
24LC16B-I/P	16K, 2K X 8 2.5V SERIAL EE	0.489	0.430	0.407	0.391
24LC16B-I/SN SMD	16K, 2K X 8 2.5V SERIAL EE	0.489	0.430	0.407	0.391
24LC32A/P	32K, 4K X 8 2.5V SERIAL EE	0.733	0.645	0.610	0.587
24LC32A-I/P	32K, 4K X 8 2.5V SERIAL EE	0.733	0.645	0.610	0.587
24LC32A-I/SN SMD	32K, 4K X 8 2.5V SERIAL EE	0.733	0.645	0.610	0.587
24LC64-I/SN SMD	64K, 8K X 8, 2.5V SER EE	0.958	0.843	0.797	0.766
24LC65-I/P	32K, 4K X 8, 2.5V SER EE	1.561	1.374	1.299	1.249
24LC65-I/SM SMD	32K, 4K X 8, 2.5V SER EE	1.596	1.405	1.328	1.277
24LC128-I/P	128K, 16K X 8, 2.5V SER EE	1.170	1.030	0.973	0.936
24LC128-I/SN SMD	128K, 16K X 8, 2.5V SER EE	1.170	1.030	0.973	0.936
24LC256-I/P	256K, 32K X 8, 2.5V SER EE	1.572	1.383	1.308	1.257
24LC256-I/SN SMD	256K, 32K X 8, 2.5V SER EE	1.572	1.383	1.308	1.257
EEPROMs - SPI BUS		1-24	25-99	100-499	500+
25C080/P	8K, 1K X 8, 5V SER EE	0.780	0.687	0.649	0.624
25C080-I/P	8K, 1K X 8, 5V SER EE	0.780	0.687	0.649	0.624
25C160-I/P	16K, 2K X 8, 5V SER EE	0.822	0.724	0.684	0.658
25C160/P	16K, 2K X 8, 5V SER EE	0.822	0.724	0.684	0.658
25C320/P	32K, 4K X 8, 5V SER EE	0.822	0.724	0.684	0.658
25C320-I/SN SMD	32K, 4K X 8, 5V SER EE	0.822	0.724	0.684	0.658
EEPROM - MICROWIRE BUS		1-24	25-99	100-499	500+
93C06	EEPROM 256	0.494	0.430	0.399	0.380
93C46	EEPROM 1K	0.261	0.226	0.210	0.200
93C56	EEPROM 2K	0.502	0.436	0.406	0.386
93C66	EEPROM 4K	0.536	0.466	0.433	0.412
93LC46/P	EEPROM 1K	0.454	0.395	0.367	0.349
93LC46-I/P	EEPROM 1K	0.454	0.395	0.367	0.349
93LC46/SN SMD	EEPROM 1K SMD	0.454	0.395	0.367	0.349
93LC46 (BR93LC46-W)	EEPROM 1K 3V	0.388	0.337	0.313	0.299
93LC46B-I/P	EEPROM 1K	0.345	0.300	0.279	0.265
93LC56/P	EEPROM 2K	0.545	0.474	0.440	0.419
93LC66/P	EEPROM 4K	0.545	0.474	0.440	0.419
93LC66/SN SMD	EEPROM 4K SMD	0.545	0.474	0.440	0.419
93LC66B-I/SN SMD	EEPROM 4K SMD	0.454	0.395	0.367	0.349
93LC86/P	EEPROM 16K 5mS 2MHz 2-6V	0.854	0.742	0.689	0.657
93LC86-I/P	EEPROM 16K 5mS 2MHz 2-6V	0.854	0.742	0.689	0.657
FLASH		1-24	25-99	100+	
28F010-150	FLASH 128K x 8 150 nS	3.983	3.645	3.375	
29F010B-120	FLASH 128K x 8 120 nS	4.746	4.343	4.022	
TTL PROM		1-24	25-99	100+	
82S23	32 x 8	0.685	0.638	0.596	
82S123	32 x 8	0.564	0.525	0.490	
82S137	1024 x 4	1.690	1.573	1.469	
GAL		1-24	25-99	100-499	500+
PALCE16V8H-25 AMD	(=GAL16V8-25LNC) 25nS 115 mA	0.927	0.824	0.735	0.687
PALCE16V8H-15 AMD	(=GAL16V8-15LNC) 15nS 115 mA	0.629	0.556	0.484	
PALCE20V8H-15 AMD	(GAL20V8)	1.252	1.107	0.963	
PALCE22V10H-25	(GAL22V10)	1.948	1.723	1.499	
GAL16V8D-25LP	(=GAL16V8-25LMC) 25nS 115 mA	0.837	0.744	0.663	0.620
GAL22V10-25LNC	(GAL22V10)	2.058	1.821	1.583	
GAL20V8-25LNC		1.096	0.970	0.843	

STATIC RAMs		1-24	25-99	100+	
6116 SKINNY	150nS 2K x 8	1.200	1.062	0.923	
6116ALP	150nS 2K x 8	1.137	1.006	0.875	
6264LP-70	70nS 8K x 8	1.296	1.147	0.997	
6264LP-100	100nS 8K x 8	1.296	1.147	0.997	
62256LP-70	70nS 32K x 8 DIP28 0.6"	1.559	1.379	1.199	
628128LP-70	70nS 128K x 8	4.304	3.808	3.311	
Microcontrollers 68HC series		1-24	25-99	100+	
MC68HC11A1FN	Microcontroller	5.351	4.580	4.281	
MC68HC705C8P	Microcontroller	4.368	4.010	3.903	
Microcontrollers 8080 series		1-24	25-99	100+	500+
80C31	CMOS Microcontroller	1.626	1.457	1.405	1.301
80C39	CMOS Microcontroller	1.937	1.735	1.673	1.549
81C55		1.573	1.464	1.367	
8253	CNT/TIMER	1.500	1.396	1.304	
82C55	PPI CMOS	1.804	1.679	1.568	1.388
PCF8583P	Serial Timer	2.327	2.058	1.790	
SAB80C535-16-N-T40/85	Microcontroller PLCC68	10.948	10.020	9.278	
P80C552EFA/08	Microcontroller PLCC68	6.251	5.351	5.001	
PCB80C562-16WP	Microcontroller PLCC68	9.655	8.836	8.182	
Microcontrollers Atmel 89C series		1-24	25-99	100+	500+
89C51	Microcontroller 4k FLASH 128X8RAM 32I/O 2TMR	2.105	1.932	1.725	
89C51 PLCC	Microcontroller 4k FLASH 128X8RAM 32I/O 2TMR	2.135	1.960	1.750	
89C52	Microcontroller 8k FLASH 256X8RAM 32I/O 3TMR	2.288	2.100	1.875	
89C52 PLCC	Microcontroller 8kFLASH 256X8RAM 32I/O 3TMR	2.515	2.309	2.061	
89C55WD	20kFLASH 256X8RAM 32I/O Hardware Watchdog	4.200	3.856	3.443	
89C1051	Microcontroller 1k FLASH	1.357	1.246	1.112	
89C2051	Microcontroller 2k FLASH	1.403	1.247	1.143	1.039
89C4051	Microcontroller 4k FLASH	2.557	2.262	1.967	
Microcontrollers Zilog Z80 series		1-24	25-99	100+	
Z80CPU		1.868	1.653	1.437	
Z80PIO		1.705	1.508	1.311	
Z80CTC		2.013	1.781	1.549	
Z80DART		2.630	2.326	2.023	
58167	Real Time Clock	6.405	5.862	5.428	

**Microchip
PIC Microcontrollers**

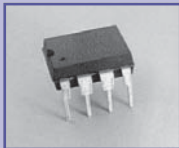

8-Lead PDIP "P"

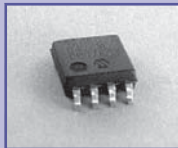

8-Lead SOIC (EIAJ)
(.208)" "SM"

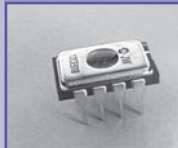

8-Lead
Side Brazed "JW"

8P 8SM 8SN 8JW

PIC12C508A-04/P	0.5K OTP,25 RAM,6I/O,TMR,DIP8
PIC12C508A-04/SM	0.5K OTP,25 RAM,6I/O,TMR,SO8 .208"
PIC12C508A-04I/SM	0.5K OTP,25 RAM,6I/O,TMR,SO8 .208"
PIC12C508A-04/SN	0.5K OTP,25 RAM,6I/O,TMR,SO8 .150"
PIC12C508A-04I/P	0.5K OTP,25 RAM,6I/O,TMR,DIP8
PIC12C508A/JW	0.5K EPR,25 RAM,6I/O,TMR,DIP8
PIC12CE518-04/P	0.5K OTP,25 RAM+16E2,6I/O,TMR,DIP8
PIC12CE518-04E/P	0.5K OTP,25 RAM+16E2,6I/O,TMR-40+125C
PIC12CE518-04/SM	0.5K OTP,25 RAM+16E2,6I/O,TMR,SO8
PIC12CE518/JW	0.5K EPR,25 RAM+16E2,6I/O,TMR,DIP8
PIC12C509A-04/P	1K OTP,41 RAM,6I/O,TMR,DIP8
PIC12C509A-04I/P	1K OTP,41 RAM,6I/O,TMR,DIP8
PIC12C509A-04/SM	1K OTP,41 RAM,6I/O,TMR,SO8 .208"
PIC12C509A-04/SN	1K OTP,41 RAM,6I/O,TMR,SO8 .150"
PIC12C509A/JW	1K OTP,41 RAM,6I/O,TMR,DIP8
PIC12C509/JW	1K OTP,41 RAM,6I/O,TMR,DIP8
PIC12CE519-04/P	1K OTP,41 RAM+16E2,6I/O,TMR,DIP8
PIC12CE519-04/SM	1K OTP,41 RAM+16E2,6I/O,TMR,SO8
PIC12CE519/JW	1K EPR,41 RAM+16E2,6I/O,TMR,DIP8
PIC12C671-04/P	1K OTP,128 RAM,6I/O,TMR,4 ADC,DIP8
PIC12C671/JW	1K EPR,128 RAM,6I/O,TMR,4 ADC,DIP8
PIC12CE673-04/P	1K OTP,128 RAM,6I/O,TMR,4 ADC,DIP8
PIC12CE673/JW	1K EPR,128 RAM,6I/O,TMR,4 ADC,DIP8
PIC12C672-04/P	2K OTP,128 RAM,6I/O,TMR,4 ADC,DIP8
PIC12C672/JW	2K EPR,128 RAM,6I/O,TMR,4 ADC,DIP8
PIC12CE674-04/P	2K OTP,128 RAM,6I/O,TMR,4 ADC,DIP8
PIC12CE674-04E/P	2K OTP,128 RAM,6I/O,TMR,4 ADC,DIP8
PIC12CE674-10I/P	2K OTP,128 RAM+16E2,6I/O,TMR,4 ADC,DIP8
PIC12CE674/JW	2K EPR,128 RAM,6I/O,TMR,4 ADC,DIP8

1-24	25-99	100+
1.029	0.931	0.887
1.045	0.946	0.901
1.145	1.036	0.987
1.078	0.976	0.930
1.145	1.036	0.987
9.166		
1.331	1.187	1.110
1.556	1.388	1.297
1.401	1.249	1.167
10.239		
1.062	0.961	0.915
1.194	1.081	1.030
1.084	0.982	0.935
1.134	1.027	0.978
9.653		
9.515		
1.453	1.295	1.210
1.522	1.357	1.268
10.811		
1.974	1.760	1.645
8.623		
2.332	2.079	1.943
9.495		
1.974	1.760	1.645
8.637		
2.324	2.072	1.936
2.720	2.425	2.266
2.719	2.424	2.265
9.495		

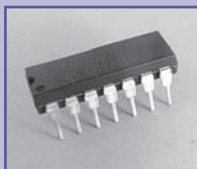

14-Lead PDIP "P"

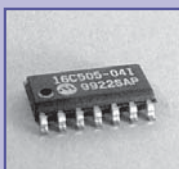

14-Lead SOIC
(.150)" "SL"

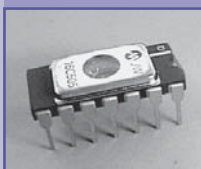

14-Lead
Side Brazed "JW"

14P 14JW

PIC16C505-04/P	1K OTP,72 RAM,12I/O,TMR,DIP14
PIC16C505-04I/P	1K OTP,72 RAM,12I/O,TMR,DIP14-40 +85C
PIC16C505-04I/SL	1K OTP,72 RAM,12I/O,TMR,SO14 .150"
PIC16L505-04I/SL	1K OTP,72 RAM,12I/O,TMR,SO14 -40 +85C
PIC16C505/JW	1K EPR,72 RAM,12I/O,TMR,DIP14

1-24	25-99	100+
1.371	1.222	1.142
1.371	1.222	1.142
1.371	1.222	1.142
1.454	1.297	1.212
6.720	5.992	5.600

18P 18JW

PIC16C54-RC/P	0.5K OTP,25 RAM,12I/O,TMR,DIP18
PIC16C54-XT/P	0.5K OTP,25 RAM,12I/O,TMR,DIP18
PIC16C54-XTI/P	0.5K OTP,25 RAM,12I/O,TMR,DIP18 -40 +85C
PIC16C54C-04/P	0.5K OTP,25 RAM,12I/O,TMR,DIP18
PIC16C54C-04I/P	0.5K OTP,25 RAM,12I/O,TMR,DIP18
PIC16C54C-20/P	0.5K OTP,25 RAM,12I/O,TMR,DIP18

2.313	2.209	2.084
2.313	2.209	2.084
2.547	2.433	2.295
1.567	1.397	1.305
1.587	1.415	1.323
1.711	1.525	1.426

PIC Microcontrollers

		1-24	25-99	100+
PIC16C54C-20I/P	0.5K OTP,25 RAM,12I/O,TMR,DIP18	1.711	1.525	1.426
PIC16C54C/JW	0.5K EPR,25 RAM,12I/O,TMR,DIP18	6.552		
PIC16C554-04/P	0.5K OTP,80 RAM,13I/O,TMR,DIP18	2.655	2.368	2.213
PIC16C554-04I/P	0.5K OTP,80 RAM,13I/O,TMR,DIP18 -40 +85C	2.922	2.606	2.435
PIC16C554/JW	0.5K EPR,80 RAM,13I/O,TMR, CDIP18	8.449		
PIC16C558-04/P	2K OTP,128 RAM,13I/O,TMR, DIP18	3.586	3.246	3.091
PIC16C558-04/SO	2K OTP,128 RAM,13I/O,TMR, DIP18	3.857	3.439	3.214
PIC16C558/JW	2K EPR,128 RAM,13I/O,TMR, CDIP18	9.997		
PIC16C56-RC/P	1K OTP,25 RAM,12I/O,TMR,DIP18	3.322	3.172	2.993
PIC16C56-XT/P	1K OTP,25 RAM,12I/O,TMR,DIP18	3.562	3.402	3.209
PIC16C56/JW	1K EPR,25 RAM,12I/O,TMR,CDIP18	9.031		
PIC16C56A-04/P	0.5K OTP,24 RAM,20I/O,TMR,DIP18	1.659	1.585	1.495
PIC16C58B-04/P	2K OTP,73 RAM,12I/O,TMR,DIP18	1.746	1.668	1.573
PIC16C58B-04I/P	2K OTP,73 RAM,12I/O,TMR,DIP18 -40 +85C	1.935	1.848	1.744
PIC16C58B/JW	2K EPR,73 RAM,12I/O,TMR,CDIP18	10.296		
PIC16C621A-04/P	1K OTP,96RAM,13I/O,TM3,2CMP,V REF,DIP18	1.819	1.737	1.639
PIC16C621A-04/SO	1K OTP,96RAM,13I/O,TM3,2CMP,V REF,SO18	1.844	1.761	1.661
PIC16C622A-04/P	2K OTP,128RAM,13I/O,TM3,2CMP,V REF,DIP18	1.978	1.889	1.782
PIC16C622A-04/SO	2K OTP,128RAM,13I/O,TM3,2CMP,V REF,SO18	2.025	1.934	1.825
PIC16C622A-20/P	2K OTP,128RAM,13I/O,TM3,2CMP,V REF,DIP18	2.122	2.026	1.912
PIC16C622A-20/SO	2K OTP,128RAM,13I/O,TM3,2CMP,V REF,SO18	2.158	2.061	1.944
PIC16C622A/JW	2K EPR,128RAM,13I/O,TM3,2CMP,V REF,CDIP18	10.139		
PIC16C623-04/P	2K OTP,128RAM,13I/O,TM3,2CMP,V REF,DIP18	2.055	1.963	1.852
PIC16C624-04/P	2K OTP,128RAM,13I/O,TM3,2CMP,V REF,DIP18	2.290	2.187	2.063
PIC16CE625-04/P	2K OTP,96RAM+128E2,TMR,2CMP,VREF,DIP18	2.601	2.484	2.344
PIC16CE625-20/P	2K OTP,96RAM+128E2,TMR,2CMP,VREF,DIP18	2.781	2.656	2.506
18P 18SO 18JW				
PIC16C711-04/P	1K OTP,68RAM,13I/O,TMR,4CH.A/D,DIP18	2.670	2.550	2.405
PIC16C711-04/SO	1K OTP,68RAM,13I/O,TMR,4CH.A/D,SO18	2.718	2.595	2.448
PIC16C711/JW	1K EPR,68RAM,13I/O,TMR,4CH.A/D,CDIP18	10.039		
PIC16C712-04/P	1K OTP,128RAM,13I/O,3TMR,4CH.A/D,DIP18	2.654	2.535	2.391
PIC16C712/JW	1K EPR,128RAM,13I/O,3TMR,4CH.A/D,CDIP18	9.166		
PIC16C716-04/P	2K OTP,128RAM,13I/O,3TMR,4CH.A/D,DIP18	2.820	2.693	2.541
PIC16C716-20/P	2K OTP,128RAM,13I/O,3TMR,4CH.A/D,DIP18	3.012	2.876	2.713
PIC16C716/JW	2K EPR,128RAM,13I/O,3TMR,4CH.A/D,CDIP18	10.171		
PIC16C717/P	2K OTP,256RAM,13I/O,3TMR,6CH.A/D,DIP18	3.235	3.089	2.914
PIC16C717/JW	2K OTP,256RAM,13I/O,3TMR,6CH.A/D,DIP18	11.920		
18P FLASH				
PIC16F84A-04/P	1K FLASH,68RAM+64E2,13I/O,TMR,DIP18	3.489	3.332	3.143
PIC16F84A-04I/P	1K FLASH,68RAM+64E2,13I/O,TMR,DIP18	3.981	3.802	3.586
PIC16F84A-04/SO	1K FLASH,68RAM+64E2,13I/O,TMR,SO18	3.607	3.444	3.250
PIC16F84A-04I/SO	1K FLASH,68RAM+64E2,13I/O,TMR,SO18	4.076	3.892	3.672
PIC16F84A-20/P	1K FLASH,68RAM+64E2,13I/O,TMR,DIP18	3.897	3.722	3.511
PIC16F84A-20I/P	1K FLASH,68RAM+64E2,13I/O,TMR,DIP18	4.287	4.094	3.862
PIC16F84A-20I/SO	1K FLASH,68RAM+64E2,13I/O,TMR,SO18	4.352	4.156	3.921
PIC16F627-04/P	1K FLASH,224RAM+128E2,16I/O,S I/O,DIP18	2.000	1.910	1.802
PIC16F627-04/SO	1K FLASH,224RAM+128E2,16I/O,S I/O,DIP18	2.032	1.940	1.830
PIC16F628-04/P	2K FLASH,224RAM+128E2,16I/O,TM3,2CMP, DIP18	2.266	2.164	2.042
PIC16F628-04I/P	2K FLASH,224RAM+128E2,16I/O,TM3,2CMP, DIP18	2.485	2.373	2.239
PIC16F628-04/SO	2K FLASH,224RAM+128E2,16I/O,TM3,2CMP..	2.313	2.209	2.084
PIC16F628-04I/SO	2K FLASH,224RAM+128E2,16I/O,TM3,2CMP..	2.547	2.433	2.295
PIC16F628-20I/P	2K FLASH,224RAM+128E2,16I/O,TM3,2CMP..	2.673	2.552	2.408
PIC16F628-20I/SO	2K FLASH,224RAM+128E2,16I/O,TM3,2CMP..	2.719	2.597	2.450

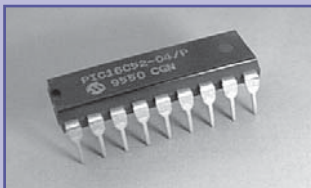

18-Lead PDIP "P"

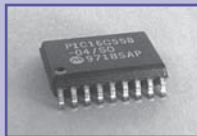
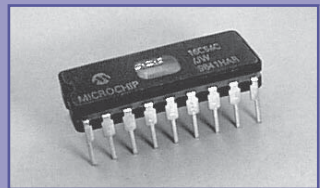
18-Lead SOIC
"SO"18-Lead
CERDIP "JW"

PIC Microcontrollers		1-24	25-99	100+
28P 28SP 28SO 28SJW				
PIC14000-04/SP	4K OTP,192RAM,22I/O,TMR,ADC,DAC,S,I/O	7.528	6.815	6.490
PIC14000/JW	4K EPR,192RAM,22I/O,TMR,ADC,DAC,S,I/O	14.524		
PIC16C57C-04/P	2K OTP,72 RAM,20I/O,TMR,DIP28	2.063	1.970	1.859
PIC16C57C-04/SP	2K OTP,72 RAM,20I/O,TMR,SDIP28	2.063	1.970	1.859
PIC16C57C-04I/P	2K OTP,72 RAM,20I/O,TMR,DIP28 -40 +85C	2.318	2.213	2.088
PIC16C57C-20/P	2K OTP,72 RAM,20I/O,TMR,DIP28	2.366	2.259	2.132
PIC16C57C/JW	2K EPR,72 RAM,20I/O,TMR,CDIP28	10.643		
PIC16C62B-04/SP	2K OTP,128RAM,22I/O,S,I/O,TM3,PWM,DIP28	2.794	2.668	2.517
PIC16LC62B-04/SP	2K OTP,128RAM,22I/O,TMR,2CMP,V REF,DIP28	2.937	2.804	2.646
PIC16C63A-04/SO	4K OTP,192RAM,22I/O,3TMR,SER,I/O,PWM	3.412	3.258	3.074
PIC16C63A-04/SP	4K OTP,192RAM,22I/O,3TMR,SER,I/O,PWM	3.412	3.258	3.074
PIC16C63A-04I/SP	4K OTP,192RAM,22I/O,3TMR,SER,I/O,PWM	3.760	3.590	3.387
PIC16C63A-20/SP	4K OTP,192RAM,22I/O,3TMR,SER,I/O,PWM	3.665	3.500	3.301
PIC16C63A/JW	4K EPR,192RAM,22I/O,3TMR,SER,I/O,PWM	10.115		
PIC16C63A/JW SLS	4K EPR,192RAM,22I/O,3TMR,SER,I/O,PWM	10.118		
PIC16C72A-04/SP	2K OTP,128 RAM,22I/O,3TMR,5CH.A/D S.I/O	3.317	3.168	2.989
PIC16C72A-04I/SP	2K OTP,128 RAM,22I/O,3TMR,5CH.A/D S.I/O	3.667	3.501	3.303
PIC16C73B-04/SP	4K OTP,192 RAM,22I/O,3TMR,5CH.A/D S.I/O	4.288	4.095	3.863
PIC16C73B-04I/SP	4K OTP,192 RAM,22I/O,3TMR,5CH.A/D S.I/O	4.713	4.500	4.246
PIC16C73B-20/SP	4K OTP,192 RAM,22I/O,3TMR,5CH.A/D S.I/O	4.584	4.377	4.130
PIC16C73B-20/SO	4K OTP,192 RAM,22I/O,3TMR,5CH.A/D S.I/O	4.575	4.369	4.122
PIC16C73B-20I/SP	4K OTP,192 RAM,22I/O,3TMR,5CH.A/D S.I/O	5.035	4.808	4.536
PIC16C73B-20I/SP	4K OTP,192 RAM,22I/O,3TMR,5CH.A/D S.I/O	5.035	4.808	4.536
PIC16C73B/JW	4K EPR,192 RAM,22I/O,3TMR,5CH.A/D S.I/O	10.881		
PIC16C745-I/SP	8K OTP,256 RAM,22I/O,3TMR,5CH.A/D S.I/O USB	5.446	5.201	4.906
PIC16C745/JW	8K EPR,256 RAM,22I/O,3TMR,5CH.A/D S.I/O USB	12.983		
PIC16C773/JW	4K EPR,256 RAM,22I/O,3TMR,6CH.A/D 12 BIT	13.189		
PIC16C773/SP	4K OTP,256 RAM,22I/O,3TMR,6CH.A/D 12 BIT	6.713	6.411	6.048
PIC16F73-I/SO	4K FLASH,192 RAM,22I/O,3TMR,5CH.A/D S.I/O	3.413	3.259	3.075
PIC16F73-I/SP	4K FLASH,192 RAM,22I/O,3TMR,5CH.A/D S.I/O	3.413	3.259	3.075
PIC16F870-I/SP	2K FLASH,128RAM+64E2,22I/O,5ADC,DIP28	2.914	2.783	2.625
PIC16F870-I/SO	2K FLASH,128RAM+64E2,22I/O,5ADC,DIP28	2.914	2.783	2.625
PIC16F872-I/SP	2K FLASH,128RAM+64E2,22I/O,5ADC,DIP28	2.914	2.783	2.625
PIC16F872-I/SO	2K FLASH,128RAM+64E2,22I/O,5ADC,DIP28	2.914	2.783	2.625
PIC16F873-04/SO	4K FLASH,192RAM+128E2,22I/O,5ADC,DIP28	4.593	4.386	4.138
PIC16F873-04I/SP	4K FLASH,192RAM+128E2,22I/O,5ADC,DIP28	5.045	4.817	4.545
PIC16F873-04/SP	4K FLASH,192RAM+128E2,22I/O,5ADC,DIP28	4.593	4.386	4.138
PIC16F873-20I/SP	4K FLASH,192RAM+128E2,22I/O,5ADC,SO28	5.399	5.156	4.864
PIC16F873-20/SO	4K FLASH,192RAM+128E2,22I/O,5ADC,DIP28	4.916	4.694	4.429
PIC16F873-20I/SP	4K FLASH,192RAM+128E2,22I/O,5ADC,DIP28	5.399	5.156	4.864
PIC16LF873-04/SO	4K FLASH,192RAM+128E2,22I/O,5ADC,SO28	4.819	4.602	4.341
PIC16LF873-04I/SO	4K FLASH,192RAM+128E2,22I/O,5ADC,SO28	5.303	5.064	4.777
PIC16C76-10/SP	8K OTP,368 RAM,22I/O,3TMR,5CH.A/D S.I/O	5.720	5.462	5.153
PIC16C76-20/SP	8K OTP,368 RAM,22I/O,3TMR,5CH.A/D S.I/O	5.813	5.551	5.237
PIC16C76-20I/SP	8K OTP,368 RAM,22I/O,3TMR,5CH.A/D S.I/O	6.392	6.104	5.759
PIC16C76/JW	8K EPR,368 RAM,22I/O,3TMR,5CH.A/D S.I/O	14.464		
PIC16F76-I/SO	8K FLASH,368 RAM,22I/O,3TMR,5CH.A/D S.I/O	4.825	4.608	4.347
PIC16F76-I/SP	8K FLASH,368 RAM,22I/O,3TMR,5CH.A/D S.I/O	4.825	4.608	4.347
PIC16F876-04/SP	8K FLASH,368RAM+256E2,22I/O,5ADC,DIP28	4.948	4.725	4.458
PIC16F876-20/SO	8K FLASH,368RAM+256E2,22I/O,5ADC,SOIC28	5.303	5.064	4.777
PIC16F876-20I/SP	8K FLASH,368RAM+256E2,22I/O,5ADC,SOIC28	5.834	5.572	5.256
PIC16F876-20/SO	8K FLASH,368RAM+256E2,22I/O,5ADC,DIP28	5.303	5.064	4.777
PIC16F876-20I/SP	8K FLASH,368RAM+256E2,22I/O,5ADC,DIP28	5.834	5.572	5.256
PIC16LF876-04I/SO	8K FLASH,368RAM+256E2,22I/O,5ADC,DIP28	5.722	5.464	5.155
PIC18C242-I/SP	16K OTP,902RAM,50I/O,4TMR,ADC,PWM,S. I/O	5.021	4.795	4.524
PIC18C252-I/SP	16K OTP,902RAM,50I/O,4TMR,ADC,PWM,S. I/O	5.449	5.203	4.909
PIC18C252/JW	16K OTP,1536RAM,23I/O,4TMR,ADC,PWM,S. I/O	13.682		

PIC Microcontrollers

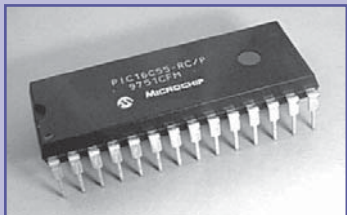

28-Lead PDIP "P"

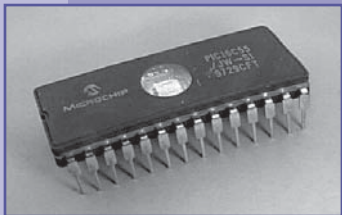

28-Lead CERDIP "JW"



28-Lead SOIC "SO"



44-Lead TQFP "PT"



44-Lead MQFP "PQ"



40-Lead PDIP "P"



28-Lead Skinny PDIP "SP"

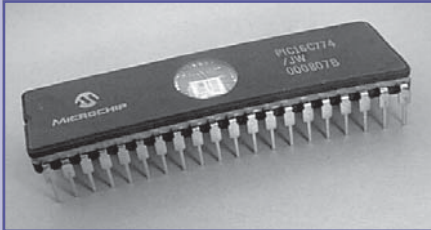

40-Lead CERDIP "JW"

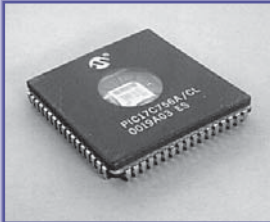

68-Lead CERQUAD "CL"

PIC Microcontrollers

		1-24	25-99	100+
40P 40PT 40PQ 40JW				
PIC16C65B-04/P	2K OTP,128RAM,331/O,3TMR,SER,I/O,PWM	3.824	3.652	3.445
PIC16C65B/JW	2K EPR,128RAM,331/O,3TMR,SER,I/O,PWM	11.316		
PIC16C74A-04/P	4K OTP,192 RAM,331/O,3TMR,8CH.A/D S.I/O	7.143	6.821	6.435
PIC16C74A-04I/P	4K OTP,192 RAM,331/O,3TMR,8CH.A/D S.I/O	7.857	7.503	7.079
PIC16C74A-10/P	4K OTP,192 RAM,331/O,3TMR,8CH.A/D S.I/O	7.651	7.306	6.893
PIC16C74A-20/PT	4K OTP,192 RAM,331/O,3TMR,8CH.A/D S.I/O	8.857	8.458	7.979
PIC16C74B-04/P	4K OTP,192 RAM,331/O,3TMR,8CH.A/D S.I/O	5.202	4.968	4.686
PIC16C74B-04I/P	4K OTP,192 RAM,331/O,3TMR,8CH.A/D S.I/O	5.725	5.467	5.158
PIC16C74B-20/P	4K OTP,192 RAM,331/O,3TMR,8CH.A/D S.I/O	5.567	5.316	5.015
PIC16C74B/JW	4K EPR,192 RAM,331/O,3TMR,8CH.A/D S.I/O	12.354		
PIC16C774/P	4K OTP,256 RAM,331/O,3TMR,10CH.A/D 12BIT	7.957	7.599	7.169
PIC16C774/JW	4K EPR,256 RAM,331/O,3TMR,10CH.A/D 12BIT	14.922		
PIC16F74-I/L	4K FLASH,192 RAM,331/O,3TMR,8CH.A/D S.I/O	4.635	4.426	4.176
PIC16F74-I/P	4K FLASH,192 RAM,331/O,3TMR,8CH.A/D S.I/O	4.143	3.956	3.732
PIC16F871-I/P	2K FLASH,128RAM+64E2,331/O,8ADC,DIP40	3.466	3.310	3.123
PIC16F874-04/P	1K FLASH,68RAM+64E2,131/O,TMR,DIP18	5.012	4.787	4.516
PIC16C77-04/P	8K OTP,368 RAM,331/O,3TMR,8CH.A/D S.I/O	5.806	5.544	5.230
PIC16C77-10I/L	8K OTP,368 RAM,331/O,3TMR,8CH.A/D S.I/O, PLCC44	7.182	6.859	6.470
PIC16C77-20/L	8K OTP,368 RAM,331/O,3TMR,8CH.A/D S.I/O PLCC44	6.532	6.238	5.885
PIC16C77-20/P	8K OTP,368 RAM,331/O,3TMR,8CH.A/D S.I/O	6.216	5.936	5.600
PIC16C77-20I/P	8K OTP,368 RAM,331/O,3TMR,8CH.A/D S.I/O	6.833	6.525	6.156
PIC16C77-20/PQ	8K OTP,368 RAM,331/O,3TMR,8CH.A/D S.I/O	6.962	6.648	6.272
PIC16C77/JW	8K EPR,368 RAM,331/O,3TMR,8CH.A/D S.I/O	14.213		
PIC16F77-I/L	8K FLASH,368RAM,331/O,8ADC, PLCC40	5.825	5.563	5.248
PIC16F77-I/P	8K FLASH,368RAM,331/O,8ADC,DIP40	5.206	4.972	4.690
PIC16F877-04/P	8K FLASH,368RAM+256E2,331/O,8ADC,DIP40	5.313	5.074	4.787
PIC16F877-04/PQ	8K FLASH,368RAM+256E2,331/O,8ADC,QFP	6.762	6.457	6.092
PIC16F877-20/P	8K FLASH,368RAM+256E2,331/O,8ADC,DIP40	5.698	5.442	5.134
PIC16F877-20I/P	8K FLASH,368RAM+256E2,331/O,8ADC,DIP40	6.270	5.987	5.649
PIC16F877-20I/PQ	8K FLASH,368RAM+256E2,331/O,8ADC,QFP	7.968	7.609	7.179
PIC16F877-20/L	8K FLASH,368RAM+256E2,331/O,8ADC,PLCC44	6.381	6.094	5.749
PIC17C42A-16/P	2K OTP,232RAM,331/O,4TMR,PWM ,DIP40	6.638	6.339	5.980
PIC17C42A/JW	2K EPR,232RAM,331/O,4TMR,PWM,CDIP40	14.180		
PIC17C44-16/P	8K OTP,454RAM,331/O,4TMR,PWM,SER I/O	9.277	8.859	8.358
PIC17C44-33/P	8K OTP,454RAM,331/O,4TMR,PWM,SER I/O	9.933	9.486	8.949
PIC17C44/JW	8K EPR,454RAM,331/O,4TMR,PWM,SER I/O	17.535		
PIC18C442-I/P	16K OTP,902RAM,50I/O,4TMR,ADC,PWM,S. I/O	5.602	5.349	5.047
PIC18C452-I/P	16K OTP,902RAM,50I/O,4TMR,ADC,PWM,S. I/O	6.046	5.773	5.447
PIC18C452/JW	16K EPR,1536RAM,34I/O,4TMR,ADC,PWM,S. I/O	15.192		
68L 68CL				
PIC16C923-04/L	4K OTP,LCD DRV,3TMR, PWM,SER I/O	4.092	3.908	3.687
PIC16C924-04/L	4K OTP,LCD DRV,3TMR,5CH A/D,PWM,S I/O	4.596	4.389	4.140
PIC16C924/CL	4K EPR,LCD DRV,3TMR,5CH A/D,PWM,S I/O	25.942		
68L 68CL				
PIC17C756A-33/L	16K OTP,902RAM,50I/O,4TMR,ADC,PWM,S. I/O	9.676	9.240	8.717
PIC17C756A/CL	16K EPR,902RAM,50I/O,4TMR,ADC,PWM,S. I/O	20.923		
PIC18C658-I/L	16K OTP,1536RAM,52I/O,4TMR,ADC,PWM,S. I/O	9.392	8.969	8.461
MCP2510-I/P	CAN Controller	3.246	3.100	2.925

For bigger quantities a project could be registered.

Thus you could receive a better price and could have a regular shipment of the required elements from Microchip.

Information about Development Systems - page 91.

Information about KEELOQ SECURE DATA PRODUCTS - page 21.

CMOS 4000 Series		1-4	5-24	25-99	100+
4000	DUAL 3-INPUT NOR-GATE+INVERTER	0.194	0.177	0.156	0.144
4001	4 x 2 INP NOR	0.154	0.140	0.123	0.114
4002	2 x 4 INP NOR	0.167	0.152	0.134	0.124
4006	18 STAGE SHIFT REG.	0.310	0.283	0.248	0.230
4007	COMPL.PAIR+INV	0.198	0.181	0.159	0.147
4008	4-BIT FULL ADDER	0.385	0.351	0.308	0.285
4009	6 INV.BUFFER	0.262	0.238	0.209	0.194
4010	6 NON-INV.BUFFER	0.263	0.239	0.210	0.195
4011	4 x 2 INP NAND	0.120	0.110	0.096	0.089
4012	2 x 4 INP NAND	0.181	0.165	0.145	0.134
4013	2 D FLIP-FLOP	0.129	0.118	0.104	0.096
4014	8-STAGE STATIC SHIFT REG.	0.335	0.306	0.268	0.248
4015	2 x 4-STAGE STATIC SHIFT REG.	0.292	0.266	0.233	0.216
4016	4 BILATERAL SWITCH	0.243	0.222	0.195	0.180
4017	DECADE COUNTER/DIVIDER	0.148	0.135	0.118	0.109
4018	PRESETTABLE DIVIDE-"N" COUNTER	0.430	0.392	0.344	0.319
4020	14-STAGE BINARY/RIPPLE COUNTER	0.256	0.233	0.205	0.190
4021	8-STAGE STATIC SHIFT REG.	0.331	0.302	0.265	0.245
4022	DIVIDE-BY-8 COUNTER/DIVIDER	0.290	0.264	0.232	0.215
4023	3 x 3 INP NAND	0.168	0.154	0.135	0.125
4024	7-STAGE BINARY/RIPPLE COUNTER	0.242	0.221	0.194	0.179
4025	3 x 3 INP NOR	0.172	0.157	0.138	0.128
4027	2 -J-K MASTER-SLAVE FLIP-FLOP	0.155	0.141	0.124	0.115
4028	BCD TO DECIMAL DECODER	0.169	0.154	0.135	0.125
4029	PRESETTABLE BIN/DEC UP/DOWN COUNTER	0.236	0.215	0.189	0.175
4030	4 EXCLUSIVE-OR	0.265	0.241	0.212	0.196
4031	64-STAGE STATIC SHIFT REG.	0.319	0.291	0.255	0.236
4032	TRIPLE SERIAL ADDER	0.370	0.337	0.296	0.274
4033	DEC.COUNTER/DIVIDER 7 SEGM.DISPL.DRIVER	0.564	0.514	0.451	0.418
4034	8-STAGE STATIC BIDIRECT.BUS REGISTER	0.837	0.763	0.670	0.620
4035	4-STAGE PARALLEL I/O SHIFT REGISTER	0.313	0.285	0.250	0.232
4038	TRIPLE SERIAL ADDER	0.405	0.369	0.324	0.300
4040	12-STAGE BINARY/RIPPLE COUNTER	0.285	0.260	0.228	0.211
4041	4 TRUE/COMPLEMENT BUFFER	0.260	0.237	0.208	0.193
4042	4 CLOCKED D LATCH	0.135	0.123	0.108	0.100
4043	4x3-STATE NOR R/S LATCH	0.268	0.244	0.214	0.198
4044	4x3-STATE NAND R/S LATCH	0.226	0.206	0.181	0.168
4046	MICROPOWER PHASE-LOCKED LOOP	0.248	0.226	0.198	0.184
4047	MONOSTABLE/ASTABLE MULTIVIBRATOR	0.243	0.221	0.194	0.180
4049	6 INVERTING BUFFER/CONVERTER	0.164	0.149	0.131	0.121
4050	6 NON-INVERTING BUFFER/CONVERTER	0.197	0.180	0.158	0.146
4051	8-CHANNEL AN. MULTIPLEXER/DEMULTIPLEXER	0.126	0.115	0.101	0.093
4051/BU4051BC ROHM	8-CHANNEL AN. MULTIPLEXER/DEMULTIPLEXER	0.274	0.250	0.219	0.203
4052	2x4-CHANNEL AN.MULTIPLEXER/DEMULTIPLEXER	0.211	0.192	0.169	0.156
4052/BU4052BC ROHM	2x4-CHANNEL AN.MULTIPLEXER/DEMULTIP.	0.278	0.254	0.223	0.206
4053	3x2-CHANNEL AN.MULTIPLEXER/DEMULTIPLEXER	0.148	0.135	0.118	0.109
4053/BU4053BC ROHM	3x2-CHANNEL AN.MULTIPLEXER/DEMULTIPLEXER	0.263	0.240	0.211	0.195
4060	14-STAGE COUNTER/DIVIDER AND OSCILLATOR	0.148	0.135	0.118	0.109
4063	4 BIT MAGNITUDE COMPARATOR	0.332	0.302	0.265	0.246
4066	4 BILATERAL SWITCH	0.120	0.110	0.096	0.089
4066/BU4066BC ROHM	4 BILATERAL SWITCH	0.198	0.180	0.158	0.147
4067	16-CHANNEL AN. MULTIPLEXER/DEMULTIPLEXER	1.086	0.990	0.869	0.805
4068	8-INPUT NAND/AND GATE	0.194	0.177	0.156	0.144
4069	6 INVERTER	0.149	0.136	0.119	0.110
4070	4 EXCLUSIVE-OR GATE	0.209	0.191	0.167	0.155
4071	4x2-INPUT OR GATE	0.140	0.128	0.112	0.104
4072	2x4-INPUT OR GATE	0.189	0.173	0.151	0.140
4073	3x3-INPUT AND GATE	0.189	0.173	0.151	0.140
4075	3x3-INPUT OR GATE	0.231	0.210	0.185	0.171
4076	4-BIT D-TYPE REGISTER	0.264	0.240	0.211	0.195
4077	4 EXCLUSIVE-NOR GATE	0.195	0.177	0.156	0.144
4078	9 INP NOR	0.260	0.236	0.208	0.192
4081	4x2-INP AND	0.200	0.182	0.160	0.148
4082	2x4-INP AND	0.142	0.130	0.114	0.105
4085	2x2-WIDE 2-INP AND-OR-INVERTER GATE	0.245	0.223	0.196	0.182
4086	EXP 4-WIDE 2-INP AND-OR-INVERTER GATE	0.199	0.181	0.159	0.148
4093	4x2-INP NAND SCHMITT TRIGGER	0.144	0.131	0.115	0.107
4094	8-STAGE SHIFT-AND-STORE BUS REG	0.193	0.176	0.154	0.143

CMOS 4000 Series		1-4	5-24	25-99	100+
4094/BU4094BC	ROHM 8-STAGE SHIFT-AND-STORE BUS REG	0.326	0.297	0.261	0.242
4095	GATED J-K MASTER-SLAVE FLIP-FLOP	0.308	0.280	0.246	0.228
4097	2x4-CHANNEL AN. MULTIPLEXER/DEMULTIPLEXER	1.436	1.308	1.148	1.063
4099	8-BIT ADDRESSABLE LATCH	0.257	0.234	0.206	0.190
4104	STROBED INVERTER/BUFFER	0.421	0.384	0.337	0.312
4502	STROBED 6 INVERTER/BUFFER	0.309	0.282	0.247	0.229
4503	6 BUFFER (3-STATE NON INVERTER)	0.307	0.279	0.245	0.227
4508	2x4-BIT LATCH (3-STATE OUTP)	1.032	0.941	0.826	0.765
4510	PRESETTABLE 4-BIT BCD UP/DOWN COUNTER	0.405	0.369	0.324	0.300
4511	BCD TO 7 SEGMENT LATCH-DECODER/DRIVER	0.202	0.184	0.162	0.150
4512	8-CH. DATA SELECTOR WITH 3-STATE OUTP	0.331	0.302	0.265	0.245
4514	4-BIT LATCH/4 TO 16 LINE DEC. (OUT HIGH)	0.508	0.463	0.407	0.377
4515	4-BIT LATCH/4 TO 16 LINE DEC. (OUT LOW)	0.614	0.560	0.491	0.455
4516	PRESETTABLE 4-BIT BINARY UP/DOWN COUNTER	0.338	0.308	0.271	0.251
4517	2x64-STAGE STATIC SHIFT REG	0.686	0.625	0.549	0.508
4518	2 BCD UP COUNTER	0.201	0.183	0.161	0.149
4519	4-BIT AND/OR SELECTOR	0.303	0.276	0.242	0.224
4520	2 BINARY UP COUNTER	0.296	0.270	0.237	0.219
4521		0.330	0.300	0.264	0.244
4526	PROGRAMMABLE BCD DIVIDER-BY-N COUNTER	0.407	0.371	0.326	0.302
4527	BCD RATE MULTIPLIER	0.349	0.318	0.279	0.259
4528	2 MONOSTABLE MULTIVIBRATOR	0.280	0.256	0.224	0.208
4529	2x4-CHANNEL/1x8-CH. ANALOG DATA SELECTOR	0.421	0.383	0.336	0.312
4531	12 BIT PARITY TREE	0.265	0.241	0.212	0.196
4532	8-INP PRIORITY ENCODER	0.319	0.291	0.256	0.237
4536	PROGRAMMABLE TIMER	0.614	0.559	0.491	0.455
4538	2 PRECISION MONOSTABLE MULTIVIBRATOR	0.221	0.201	0.176	0.163
4541	PROGRAMMABLE TIMER	0.197	0.179	0.157	0.146
4543	BCD-TO-7 SEGMENT LATCH/DECODER/DRIVER	0.212	0.193	0.170	0.157
4547	HIGH CURRENT BCD-7-SEGM.DECODER/DRIVER	1.404	1.279	1.123	1.040
4553	3-DIGIT BCD COUNTER	1.252	1.141	1.002	0.927
4555	2x1-OF-4 DECODER/DEMULTIPL. (OUT HIGH)	0.310	0.282	0.248	0.230
4556	2x1-OF-4 DECODER/DEMULTIPLEXER (OUT LOW)	0.316	0.288	0.253	0.234
4560	NBCD ADDER	0.629	0.573	0.503	0.466
4561	9 S COMPLEMENTER	0.505	0.460	0.404	0.374
4584=40106	6 SCHMITT TRIGGER	0.290	0.264	0.232	0.215
4585	4-BIT MAGNITUDE COMPARATOR	0.297	0.271	0.238	0.220
4597 +	8 BIT LATCH	2.155	1.963	1.724	1.596
40106=4584	6 SCHMITT TRIGGER	0.139	0.126	0.111	0.103
40160	DECADE COUNTER/ASYNCHRONOUS CLEAR	0.520	0.474	0.416	0.385
40161	BINARY COUNTER/ASYNCHRONOUS CLEAR	0.520	0.474	0.416	0.385
40162	DECADE COUNTER/SYNCHRONOUS CLEAR	0.473	0.430	0.378	0.350
40163	BINARY COUNTER/SYNCHRONOUS CLEAR	0.449	0.409	0.359	0.333
40174	6 D FLIP-FLOP	0.441	0.402	0.353	0.327
40175	4 D FLIP-FLOP	0.441	0.402	0.353	0.327
40192	PRESETTABLE 4-BIT BCD UP/DOWN COUNTER	0.628	0.572	0.502	0.465
40193	PRESETTABLE 4-BIT BINARY UP/DOWN COUNTER	0.593	0.540	0.474	0.439
40194	4-BIT BIDIRECTIONAL UNIVERSAL SHIFT REG	0.413	0.376	0.330	0.306
40244	8 BUFFER WITH 3-STATE OUTP	0.846	0.771	0.677	0.627
40245	8 BUS TRANSCEIVER WITH 3-STATE OUTP	0.911	0.830	0.729	0.675
ICs 74HC Series		1-4	5-24	25-99	100+
74HC00	4x2-INP NAND	0.130	0.118	0.104	0.096
74HC02	4x2-INP NOR	0.118	0.108	0.095	0.088
74HC03	4x2-INP NAND O.D.	0.131	0.120	0.105	0.097
74HC04	6 INVERTER	0.123	0.112	0.099	0.091
74HC05	6 INVERTER O.D.	0.134	0.123	0.108	0.100
74HC08	4x2-INP AND	0.123	0.112	0.099	0.091
74HC10	3x3-INP NAND	0.124	0.113	0.099	0.092
74HC14	6 INVERTING SCHMITT TRIGGER	0.147	0.134	0.117	0.109
74HC20	2x4-INP NAND	0.185	0.169	0.148	0.137
74HC21	3x3-INP POSITIVE NOR	0.188	0.171	0.150	0.139
74HC27	3x3-INP NOR	0.185	0.169	0.148	0.137
74HC30	8-INP NAND	0.124	0.113	0.099	0.092
74HC32	4x2-INP OR	0.150	0.137	0.120	0.111
74HC42	BCD TO DECIMAL DECODER(1-10)	0.228	0.208	0.182	0.169
74HC73	2 J-K FLIP-FLOPS WITH CLEAR	0.350	0.319	0.280	0.260

ICs 74HC Series		1-4	5-24	25-99	100+
74HC74	2 D FLIP-FLOP WITH PRESET AND CLEAR	0.132	0.120	0.105	0.098
74HC75	4 BISTABLE TRANSPARENT LATCH	0.211	0.192	0.169	0.156
74HC85	4-BIT MAGNITUDE COMPARATOR	0.393	0.358	0.314	0.291
74HC86	4x2-1NP EXCLUSIVE OR	0.135	0.123	0.108	0.100
74HC109	2 J-K FLIP-FLOPS WITH PRESET AND CLEAR	0.250	0.228	0.200	0.185
74HC123	2 RETRIGGERABLE MONOSTABLE	0.173	0.157	0.138	0.128
74HC125	3-STATE 4 BUFFERS	0.160	0.146	0.128	0.118
74HC126	3-STATE 4 BUFFERS	0.140	0.128	0.112	0.104
74HC132	4x2-1NP NAND SCHMITT TRIGGER	0.194	0.177	0.155	0.144
74HC137	3-TO-8 LINE DEC.W ADDR.LATCHES(INV OUP)	0.294	0.268	0.235	0.218
74HC138	3-TO-8 LINE DECODER	0.162	0.148	0.130	0.120
74HC139	2x2-TO-4 LINE DECODER	0.156	0.142	0.124	0.115
74HC147	10-TO-4 LINE PRIORITY ENCODER	0.404	0.368	0.323	0.299
74HC148	8-TO-3 LINE PRIORITY ENCODER	0.334	0.304	0.267	0.248
74HC151	8-CHANNEL MULTIPLEXER	0.211	0.192	0.169	0.156
74HC153	2x4-1NP MULTIPLEXER	0.237	0.215	0.189	0.175
74HC154	4-TO-16 LINE DECODER	0.637	0.580	0.509	0.471
74HC155	2x2-TO-4 LINE DECODERS/DEMULTIPLEXERS	0.284	0.258	0.227	0.210
74HC157	4x2-1NP MULTIPLEXER	0.172	0.157	0.138	0.128
74HC158	4x2-1NP MULTIPLEXER (INV OUT)	0.305	0.278	0.244	0.226
74HC161	SYNCHRONOUS BINARY COUNTER	0.240	0.218	0.192	0.177
74HC163	PRESETTABLE SYNCHR.4-BIT BINARY COUNTER	0.240	0.218	0.192	0.177
74HC164	8-BIT SERIAL-IN/PARALLEL-OUT SHIFT REG	0.222	0.202	0.178	0.164
74HC165	8-BIT PAR.IN/SER. OUT SHIFT REG.	0.275	0.251	0.220	0.204
74HC166	8-BIT PAR.IN/SER. OUT SHIFT REG. W RESET	0.291	0.265	0.233	0.216
74HC173	3-STATE 4 FLIP-FLOP	0.367	0.335	0.294	0.272
74HC174	6 D FLIP-FLOPS WITH CLEAR	0.205	0.186	0.164	0.152
74HC175	4 D-TYPE FLIP-FLOP WITH CLEAR	0.194	0.176	0.155	0.143
74HC190	SYNCHR.DEC.UP/DOWN COUNT.W MODE CTRL	0.324	0.295	0.259	0.240
74HC193	SYNCHRONOUS BINARY UP/DOWN COUNTERS	0.344	0.313	0.275	0.255
74HC194	4-BIT BIDIR.UNIVERSAL SHIFT REGISTER	0.221	0.201	0.177	0.164
74HC238		0.216	0.197	0.173	0.160
74HC240	INVERTING 8x3-STATE BUFFER	0.206	0.187	0.164	0.152
74HC241	8x3-STATE BUFFER	0.206	0.187	0.164	0.152
74HC242	INVERTING 4x3-STATE TRANSCEIVER	0.453	0.413	0.363	0.336
74HC243	4x3-STATE TRANSCEIVER	0.432	0.394	0.346	0.320
74HC244	8x3-STATE BUFFER	0.214	0.195	0.172	0.159
74HC245	8x3-STATE TRANSCEIVER	0.233	0.212	0.186	0.173
74HC251	8-CHANNEL 3-STATE MULTIPLEXER	0.185	0.169	0.148	0.137
74HC257	4x2-CHANNEL 3-STATE MULTIPLEXER	0.185	0.169	0.148	0.137
74HC259	8-BIT ADDR. LATCH/3-TO-8 LINE DECODER	0.190	0.173	0.152	0.141
74HC273	8 D FLIP-FLOPS WITH CLEAR	0.216	0.197	0.173	0.160
74HC283	4-BIT BINARY ADDER WITH FAST CARRY	0.263	0.240	0.211	0.195
74HC373	3-STATE 8 D-TYPE LATCH	0.214	0.195	0.172	0.159
74HC374	3-STATE 8 D-TYPE FLIP-FLOP	0.214	0.195	0.172	0.159
74HC377	OCTAL D-TYPE FLIP FLOP WITH ENABLE	0.231	0.211	0.185	0.171
74HC390	2x4-BIT DECADE COUNTER	0.301	0.275	0.241	0.223
74HC393	2x4-BIT BINARY COUNTER	0.297	0.270	0.237	0.220
74HC541	8x3-STATE BUFFER	0.285	0.260	0.228	0.211
74HC573	3-STATE 8 D-TYPE LATCH	0.209	0.191	0.167	0.155
74HC574	3-STATE 8 D-TYPE EDGE-TRIGG. FLIP-FLOP	0.209	0.191	0.167	0.155
74HC595	8 BIT SERIAL TO PARALLEL SHIFT REGISTER	0.257	0.234	0.205	0.190
74HC597		0.237	0.216	0.189	0.175
74HC688	8-BIT MAGNITUDE COMPARATOR	0.307	0.280	0.246	0.228
74HC4040	12-BIT BINARY COUNTER	0.218	0.199	0.175	0.162
74HC4046	PHASE-LOCKED-LOOP+VCO	0.442	0.403	0.354	0.328
74HC4051	8-CHANNEL AN. MULTIPLEXER/DEMULTIPLEXER	0.218	0.199	0.175	0.162
74HC4052		0.218	0.199	0.175	0.162
74HC4053		0.218	0.199	0.175	0.162
74HC4060	14-STAGE BINARY COUNTER	0.242	0.220	0.194	0.179
74HC4066	4 ANALOG SWITCH	0.181	0.165	0.144	0.134
74HC4094	8-STAGE SHIFT-AND-STORE BUS REG	0.224	0.204	0.179	0.166
74HC4514	4-TO-16 LINE DECODER WITH LATCH	0.720	0.656	0.576	0.533
74HC4538	2 RETRIGGERABLE MONOST. MULTIVIBRATOR	0.227	0.207	0.182	0.169

ICs 74HCT Series		1-4	5-24	25-99	100+
74HCT00	4x2-1NP NAND	0.123	0.112	0.099	0.091
74HCT02	4x2-1NP NOR	0.137	0.124	0.109	0.101
74HCT03	4x2-1NP NAND(OPEN DRAIN)	0.141	0.129	0.113	0.105
74HCT04	6 INVERTER	0.123	0.112	0.099	0.091
74HCT05	6 INVERTER O. D.	0.127	0.116	0.102	0.094
74HCT08	4x2-1NP AND	0.123	0.112	0.099	0.091
74HCT10	3x3-1NP NAND	0.183	0.166	0.146	0.135
74HCT11	3x3-1NP AND	0.184	0.168	0.147	0.137
74HCT14	6 INVERTING SCHMITT TRIGGER	0.147	0.134	0.117	0.109
74HCT20	2x4-1NP NAND	0.185	0.169	0.148	0.137
74HCT27	3x3-1NP NOR	0.184	0.168	0.147	0.137
74HCT30	8-1NP NAND	0.186	0.170	0.149	0.138
74HCT32	4x2-1NP OR	0.129	0.118	0.103	0.096
74HCT42	BCD TO DECIMAL DECODER(1-10)	0.469	0.428	0.375	0.348
74HCT74	2 D FLIP-FLOP W PRESET/CLEAR	0.175	0.159	0.140	0.129
74HCT75	4 BISTABLE TRANSPARENT LATCH	0.270	0.246	0.216	0.200
74HCT85	4-BIT MAGNITUDE COMPARATOR	0.175	0.159	0.140	0.130
74HCT86	4x2-1NP EXCLUSIVE OR	0.171	0.156	0.137	0.127
74HCT107	2 JK FLIP-FLOP WITH RESET	0.226	0.206	0.181	0.168
74HCT109	2 J-K FLIP-FLOPS WITH PRESET AND CLEAR	0.250	0.228	0.200	0.185
74HCT112	2 J-K FLIP-FLOPS W PRESET/CLEAR	0.385	0.351	0.308	0.285
74HCT123	2 RETRIGGERABLE MONOSTABLE	0.173	0.157	0.138	0.128
74HCT125	3-STATE 4 BUFFERS	0.166	0.151	0.133	0.123
74HCT126	3-STATE 4 BUFFERS	0.153	0.140	0.123	0.113
74HCT132	4x2-1NP NAND SCHMITT TRIGGER	0.153	0.140	0.123	0.113
74HCT137	3-TO-8 LINE DEC.W ADDR.LATCHES(INV OUTP)	0.320	0.292	0.256	0.237
74HCT138	3-TO-8 LINE DECODER	0.156	0.142	0.124	0.115
74HCT139	2x2-TO-4 LINE DECODER	0.194	0.177	0.155	0.144
74HCT147	10-TO-4 LINE PRIORITY ENCODER	0.420	0.382	0.356	0.311
74HCT151	8-CHANNEL MULTIPLEXER	0.218	0.199	0.175	0.162
74HCT153	2x4-1NP MULTIPLEXER	0.260	0.237	0.208	0.193
74HCT157	4x2-1NP MULTIPLEXER	0.202	0.184	0.161	0.149
74HCT158	4x2-1NP MULTIPLEXER (INV OUT)	0.310	0.283	0.248	0.230
74HCT160	PRESETTABLE SYNCHR.BGD DECADE COUNTER	0.317	0.289	0.253	0.235
74HCT161	SYNCHRONOUS BINARY COUNTER	0.273	0.249	0.218	0.202
74HCT162	PRESETTABLE SYNCHR.BGD DECADE COUNTER	0.436	0.397	0.349	0.323
74HCT163	PRESETTABLE SYNCHR.4-BIT BINARY COUNTER	0.219	0.200	0.176	0.163
74HCT164	8-BIT SERIAL-IN/PARALLEL-OUT SHIFT REG	0.194	0.176	0.155	0.143
74HCT165	8-BIT PAR.-IN/SER.-OUT SHIFT REG.	0.190	0.173	0.152	0.141
74HCT166	8-BIT PAR.IN/SER. OUT SHIFT REG. W RESET	0.215	0.196	0.172	0.159
74HCT173	3-STATE 4 FLIP-FLOP	0.358	0.327	0.287	0.266
74HCT174	6 D FLIP-FLOPS WITH CLEAR	0.204	0.186	0.163	0.151
74HCT191	SYNCHR.BIN.UP/DOWN COUNTER	0.459	0.418	0.367	0.340
74HCT192	SYNCHRONOUS DECADE UP/DOWN COUNTER	0.540	0.492	0.432	0.400
74HCT193	SYNCHRONOUS BINARY UP/DOWN COUNTERS	0.416	0.379	0.333	0.308
74HCT194	4-BIT BIDIR.UNIVERSAL SHIFT REGISTER	0.426	0.388	0.341	0.316
74HCT195	4-BIT PARALLEL ACCESS SHIFT REGISTER	0.539	0.491	0.431	0.399
74HCT238	3-TO-8 LINE DECODER/DEMUTIPLEXER	0.368	0.335	0.295	0.273
74HCT240	INVERTING 8x3-STATE BUFFER	0.214	0.195	0.172	0.159
74HCT241	8x3-STATE BUFFER	0.355	0.324	0.284	0.263
74HCT242	INVERTING 4x3-STATE TRANSCEIVER	0.464	0.423	0.371	0.344
74HCT244	8x3-STATE BUFFER	0.219	0.200	0.176	0.163
74HCT245	8x3-STATE TRANSCEIVER	0.214	0.195	0.172	0.159
74HCT251	8-CHANNEL 3-STATE MULTIPLEXER	0.234	0.213	0.187	0.173
74HCT257	4x2-CHANNEL 3-STATE MULTIPLEXER	0.318	0.289	0.254	0.235
74HCT258	4x2-CHANNEL 3-STATE MULTIPLEXER(INV OUT)	0.321	0.292	0.257	0.238
74HCT259	8-BIT ADDR. LATCH/3-TO-8 LINE DECODER	0.198	0.181	0.159	0.147
74HCT273	8 D FLIP-FLOPS WITH CLEAR	0.214	0.195	0.171	0.158
74HCT354	8-1NP.MULTIPLEXER/REG. + TRANSP.DATA LATCH	0.878	0.799	0.702	0.650
74HCT356	8-INPUT MULTIPLEXER/REGISTER	1.006	0.916	0.805	0.740
74HCT373	3-STATE 8 D-TYPE LATCH	0.209	0.190	0.167	0.155
74HCT374	3-STATE 8 D-TYPE FLIP-FLOP	0.223	0.203	0.178	0.165
74HCT377	OCTAL D-TYPE FLIP FLOP WITH ENABLE	0.319	0.290	0.255	0.236
74HCT390	2x4-BIT DECADE COUNTER	0.322	0.293	0.257	0.238
74HCT393	2x4-BIT BINARY COUNTER	0.318	0.290	0.254	0.235
74HCT534	3-STATE 8 D-TYPE FLIP-FLOP	0.616	0.561	0.493	0.457
74HCT573	3-STATE 8 D-TYPE LATCH	0.218	0.199	0.175	0.162
74HCT574	3-STATE 8 D-TYPE EDGE-TRIGG.FLIP-FLOP	0.218	0.199	0.175	0.162

ICs 74HCT Series		1-4	5-24	25-99	100+
74HCT595	8 BIT SERIAL TO PARALLEL SHIFT REGISTER	0.260	0.237	0.208	0.193
74HCT597		0.418	0.381	0.334	0.309
74HCT670	4x4 REGISTER FILE	0.520	0.474	0.416	0.386
74HCT688	8-BIT MAGNITUDE COMPARATOR	0.281	0.256	0.225	0.208
74HCT4046	PHASE-LOCKED-LOOP+VCO	0.527	0.480	0.421	0.390
74HCT4053	3x2-CHANNEL AN.MULTIPLEXER/DEMULTIPLEXER	0.223	0.203	0.178	0.165
74HCT4066	4 ANALOG SWITCH	0.244	0.222	0.195	0.181
74HCT4094	8-STAGE SHIFT-AND-STORE BUS REG	0.339	0.309	0.271	0.251
74HCT4511	BCD TO 7 SEGMENT LATCH/DECODER/DRIVER	0.328	0.299	0.263	0.243
74HCT4518	DUAL BCD UP COUNTER	0.350	0.319	0.280	0.259
74HCT4520	DUAL BIN UP COUNTER	0.340	0.309	0.272	0.252
TTL Standard Series		1-4	5-24	25-99	100+
7406	HEX INVERTER/BUFFER 30 V O/P O.C.	0.221	0.201	0.176	0.163
7407	HEX BUFFER 30 V O/P O.C.	0.221	0.201	0.176	0.163
7438	QUAD 2 INPUT NAND BUFFER O.C.	0.244	0.222	0.195	0.180
7442	BCD DECIMAL DECODER	0.304	0.277	0.243	0.225
7445	BCD DECIMAL DECODER 30V O/P	0.666	0.607	0.533	0.494
7447	BCD SEVEN SEGMENT DECODER O.C.	1.107	1.009	0.886	0.820
TTL IC - LS Series		1-4	5-24	25-99	100+
74LS00	QUAD 2 INPUT NAND	0.160	0.146	0.128	0.118
74LS02	QUAD 2 INPUT NOR	0.176	0.160	0.141	0.130
74LS04	HEX INVERTER	0.167	0.153	0.134	0.124
74LS05	HEX INVERTER O.C.	0.153	0.139	0.122	0.113
74LS06	HEX INVERTER/BUFFER 30 V O/P O.C.	0.441	0.401	0.352	0.326
74LS07	HEX BUFFER 30 V O/P O.C.	0.394	0.359	0.315	0.292
74LS08	QUAD 2 INPUT AND	0.164	0.150	0.131	0.122
74LS10	TRIPLE 3 INPUT NAND	0.157	0.143	0.126	0.116
74LS11	TRIPLE 3 INPUT AND	0.144	0.131	0.115	0.107
74LS12	TRIPLE 3 INPUT NAND O.C.	0.221	0.202	0.177	0.164
74LS14	HEX INVERTER SCHMITT	0.198	0.181	0.159	0.147
74LS15	TRIPLE 3 INPUT AND O.C.	0.221	0.202	0.177	0.164
74LS20	DUAL 4 INPUT NAND	0.209	0.191	0.167	0.155
74LS21	DUAL 4 INPUT AND	0.136	0.124	0.109	0.101
74LS22	DUAL 4 INPUT NAND O.C.	0.209	0.191	0.167	0.155
74LS26	QUAD 2 INPUT GATE NAND 15 V O/P	0.136	0.124	0.109	0.101
74LS27	TRIPLE 3 INPUT NOR	0.157	0.143	0.126	0.116
74LS28	QUAD 2 INPUT NOR BUFFER	0.209	0.191	0.167	0.155
74LS30	8 INPUT NAND	0.160	0.146	0.128	0.118
74LS32	QUAD 2 INPUT OR	0.160	0.146	0.128	0.118
74LS33	QUAD 2 INPUT NOR BUFFER O.C.	0.221	0.202	0.177	0.164
74LS37	QUAD 2 INPUT NAND BUFFER	0.234	0.213	0.187	0.173
74LS38	QUAD 2 INPUT NAND BUFFER O.C.	0.160	0.146	0.128	0.118
74LS40	DUAL 4 INPUT NAND BUFFER	0.221	0.202	0.177	0.164
74LS42	BCD DECIMAL DECODER	0.370	0.337	0.296	0.274
74LS47	BCD SEVEN SEGMENT DECODER O.C.	0.346	0.315	0.277	0.256
74LS48	BCD SEVEN SEGMENT DECODER	0.571	0.520	0.457	0.423
74LS49	BCD SEVEN SEGMENT DECODER O.C.	0.793	0.722	0.634	0.587
74LS51	DUAL 2 WIDE 2 INPUT AND-OR-INVERT	0.221	0.202	0.177	0.164
74LS55	EXPANDABLE 4 WIDE 2 INPUT AND-OR-INVERT	0.221	0.202	0.177	0.164
74LS73	DUAL J-K TYPE FLIP FLOP	0.304	0.277	0.243	0.225
74LS74	DUAL D-TYPE FLIP FLOP	0.195	0.177	0.156	0.144
74LS75	QUAD LATCH	0.297	0.271	0.238	0.220
74LS83	4 BIT BINARY FULL ADDER	0.186	0.169	0.149	0.138
74LS85	4 BIT COMPARATOR	0.410	0.373	0.328	0.303
74LS86	QUAD EXCLUSIVE OR	0.246	0.224	0.197	0.182
74LS90	DECADE COUNTER	0.321	0.292	0.257	0.238
74LS93	4 BIT BINARY COUNTER	0.478	0.436	0.382	0.354
74LS95	4 BIT SHIFT REGISTER PAR.IN SERIAL OUT	0.376	0.343	0.301	0.279
74LS107	DUAL J-K FLIP FLOP WITH CLEAR	0.280	0.255	0.224	0.207
74LS112	DUAL J-K FLIP FLOP PRESET + CLEAR	0.168	0.153	0.134	0.124
74LS113	DUAL J-K FLIP FLOP WITH PRESET	0.168	0.153	0.134	0.124
74LS114	DUAL J-K FLIP FLOP PRESET+CLEAR	0.319	0.290	0.255	0.236
74LS122	MONOSTABLE MULTIVIBRATOR	0.332	0.303	0.266	0.246
74LS123	DUAL MONOSTABLE MULTIVIBRATOR	0.212	0.193	0.170	0.157
74LS125	QUAD 3 STATE BUFFER	0.245	0.224	0.196	0.182

TTL IC - LS Series		1-4	5-24	25-99	100+
74LS126	QUAD 3 STATE BUFFER	0.297	0.271	0.238	0.220
74LS132	QUAD 2 INPUT NAND SHCMITT	0.232	0.211	0.185	0.172
74LS138	3 LINE TO 8 DECODER/DEMULTIPLXER	0.212	0.193	0.170	0.157
74LS139	DUAL 2 LINE TO 4 LINE DECODER/DEMULTIPL.	0.248	0.226	0.198	0.184
74LS145	BCD DECIMAL DECODER/DRIVER 15 V O/P	0.357	0.326	0.286	0.265
74LS148	8 TO 3LINE PRIORITY ENCODER	0.543	0.495	0.435	0.402
74LS151	8 BIT DATA SELECTOR	0.224	0.204	0.179	0.166
74LS153	DUAL 4 LINE TO 1 LINE SELECTOR	0.240	0.218	0.192	0.177
74LS154	4-16 LINE DECODER	1.155	1.052	0.924	0.856
74LS155	DUAL 2 TO 4 LINA DECODER	0.269	0.245	0.215	0.199
74LS156	DUAL 2 TO 4 LINA DECODER O.C.	0.269	0.245	0.215	0.199
74LS157	QUAD 2 TO 1 LINE SELECTOR	0.240	0.219	0.192	0.178
74LS158	QUAD 2 LINE TO 1 LINE SELECTOR INVERTING	0.269	0.245	0.215	0.199
74LS160	SYNCHRONOUS DECADE COUNTER DIR. CLEAR	0.334	0.304	0.267	0.247
74LS161	SYNCHRONOUS BINARY COUNTER DIR. CLEAR	0.267	0.244	0.214	0.198
74LS162	SYNCHRONOUS DECADE COUNTER SYNC.CL.	0.295	0.268	0.236	0.218
74LS163	SYNCHRONOUS BINARY COUNTER SYNC. CL.	0.255	0.233	0.204	0.189
74LS164	8 BIT SHIFT REGISTER PISO	0.235	0.214	0.188	0.174
74LS165	8 BIT SHIFT REGISTER PISO	0.202	0.184	0.162	0.150
74LS166	8 BIT SHIFT REGISTER PISO	0.246	0.224	0.197	0.183
74LS169	SYNCHRONOUS BINARY UP DOWN COUNTER	0.386	0.351	0.308	0.286
74LS173	QUAD 3 STATE LATCH	0.386	0.351	0.308	0.286
74LS174	HEX D-TYPE FLIP FLOP	0.213	0.194	0.171	0.158
74LS175	QUAD D-TYPE FLIP FLOP	0.287	0.261	0.230	0.213
74LS190	REVERSABLE DECADE COUNTER O.C.	0.313	0.285	0.250	0.232
74LS191	REVERSABLE BINARY COUNTER	0.313	0.285	0.250	0.232
74LS193	SYNC.UP/DOWN DUAL CLK COUNTER	0.271	0.247	0.217	0.201
74LS194	4 BIT BIDIR. UNIV. SHIFT REG.	0.483	0.440	0.386	0.358
74LS195	4 BIT PAR. ACCESS SHIFT REG.	0.271	0.247	0.217	0.201
74LS197	BINARY COUNTER	0.396	0.361	0.317	0.294
74LS221	DUAL MONOSTABLE	0.303	0.276	0.242	0.224
74LS240	OCTAL INVERTER 3 STATE	0.336	0.306	0.269	0.249
74LS241	OCTAL BUFFER NON INVERTED 3 STATE	0.340	0.310	0.272	0.252
74LS242	QUAD BUS TRANSCEIVER INVERTED 3 STATE	0.359	0.327	0.288	0.266
74LS243	QUAD BUS TRANSCEIVER NON INV. 3 STATE	0.349	0.318	0.279	0.259
74LS244	OCTAL 3 STATE DRIVER	0.274	0.249	0.219	0.203
74LS245	OCTAL 3 STATE BUS TRANSCEIVER	0.261	0.238	0.209	0.193
74LS247	BCD SEVEN SEGMENT DECODER O.C.	0.473	0.431	0.378	0.350
74LS248	BCD SEVEN SEGMENT DECODER	0.478	0.436	0.383	0.354
74LS251	8 INPUT SELECTOR 3 STATE	0.356	0.324	0.285	0.264
74LS253	DUAL 4 LINE TO 1 LINE SELECTOR 3 STATE	0.385	0.350	0.308	0.285
74LS257	QUAD 2 TO 1 LINE SELECTOR 3 ST. NON INV	0.240	0.218	0.192	0.177
74LS258	QUAD 2 TO 1 LINE SELECTOR 3 STATE INV	0.332	0.302	0.265	0.246
74LS259	8 BIT ADDRESSABLE LATCH	0.437	0.398	0.349	0.323
74LS273	OCTAL D-TYPE FLIP FLOP WITH CLEAR	0.277	0.252	0.221	0.205
74LS280	9 BIT PARITY GENERATOR/CHECKER	0.192	0.175	0.153	0.142
74LS283	4 BIT FULL CLEAR	0.313	0.285	0.251	0.232
74LS293	4 BIT BINARY COUNTER	0.367	0.334	0.293	0.272
74LS298	QUAD 2 INPUT MULTIPLEXERWITH STORAGE	0.334	0.304	0.267	0.247
74LS299	8 BIT UNIVERSAL SHIFT/STORAGE REGISTER	0.846	0.771	0.677	0.627
74LS322	8 BIT SERIAL/PARALLEL REG. (AMD25LS22)	0.806	0.734	0.644	0.597
74LS323	8 BIT SHIFT/STORAGE REGISTER (AMD25LS23)	0.838	0.764	0.670	0.621
74LS365	HEX BUS DRIVER	0.188	0.171	0.151	0.139
74LS367	HEX BUS DRIVER	0.188	0.171	0.151	0.139
74LS368	HEX BUS DRIVER	0.285	0.260	0.228	0.211
74LS373	OCTAL TRANSPARENTLATCH	0.251	0.229	0.201	0.186
74LS374	OCTAL D-TYPE FLIP FLOP	0.251	0.229	0.201	0.186
74LS377	OCTAL D-TYPE FLIP FLOP WITH ENABLE	0.396	0.361	0.317	0.293
74LS390	DUAL DECADE COUNTER	0.344	0.314	0.275	0.255
74LS393	DUAL BINARY COUNTER	0.357	0.325	0.286	0.264
74LS399	QUAD 2 INPUT MULTIPLEXER P/O (AMD25LS09)	0.339	0.308	0.271	0.251
74LS423	DUAL LS422 (NO TRIGGER FROM CLR)	0.303	0.276	0.242	0.224
74LS540	OCTAL BUFFER AND LINE DR/RX INVERTED	0.396	0.361	0.317	0.293
74LS593	8 BIT BIN.COUNTERS W.INP.REG.AND 3ST./I/O	1.166	1.062	0.933	0.864
74LS645	OCTAL 3 STATE BUS TRANSCEIVER	0.451	0.411	0.360	0.334
74LS670	4x4 REGISTER FILES	0.341	0.311	0.273	0.253

Transistors 2N, PN		1-24	25-99	100+	500+	
2N1309	PNP 20Vcb0.3A 0.15W	0.092	0.086	0.080	0.071	
2N2219A	NPN 75V 800mA 0.8W	0.286	0.266	0.249	0.220	
2N2222A	NPN 75V 800mA 0.5W	0.047	0.043	0.040	0.036	
PN2222A ROHM	NPN 75/40V 600mA 0.625W 25/60nS TO92	0.056	0.046	0.040	0.036	
PN2222A	NPN 75/40V 1A 0.625W 25/60nS TO92	0.046	0.038	0.033	0.030	
2N2904	PNP 40V 600mA 0.6W					
2N2905	NPN 40V 600mA 0.6W					
PN2907A ROHM	PNP 60V/60 600mA 0.625W 50/100nS TO92	0.054	0.045	0.039	0.035	
2N3866	NPN 30V 500mA 3.5W 500MHz	0.850	0.791	0.739	0.654	
2N5401	PNP 150V 600mA 500mW 300MHz TO92	0.047	0.039	0.033	0.030	
2N5551	NPN 160V 600mA	0.047	0.039	0.033	0.030	
Transistors 2S		1-9	10-99	100-999	1000+	5000+
2SA733	PNP 40V 100mA 0.25W	0.060	0.056	0.052	0.046	
2SA1964 ROHM	PNP 160V 1.5A 2(20)W 150 MHz TO220FP	0.219	0.195	0.179	0.162	
2SB1436R ROHM	PNP 30/20V 5A 5W Hfe 180-390 TO126FP	0.240	0.213	0.196	0.178	
2SC1740S ROHM	NPN 60/50V 150mA 0.3W 180 MHz	0.036	0.032	0.030	0.026	0.025
2SC1971	NPN 35/17V 2A 12.5W VHF	2.673	2.488	2.323	2.056	
2SC4043S ROHM	NPN 20/11V 50mA 0.3W 3.2GHz 3.5dB	0.045	0.041	0.037	0.033	0.031
2SC4081 ROHM	NPN 40V 100mA	0.027	0.025	0.023	0.020	0.019
2SC5248 ROHM	NPN 160V 1.5A 2(20)W 150 MHz TO220FP					
2SD2166Q ROHM	NPN 50/20V 5A 5W Hfe 120-270 TO126FP					
2SB772	PNP 40/30V 3A 10W Hfe 60-400 80MHz TO126	0.157	0.142	0.131	0.115	0.11
2SD882	NPN 40/30V 3A 10W Hfe 60-400 90MHz TO126	0.157	0.142	0.131	0.115	0.11
SMD version of 2SC4043S - 2SC3838K - page 17.						
SMD version of 2SC1740S - 2SC2412K - page 17.						
Transistors BC		1-9	10-99	100-499	500-1999	2000+
BC327-25	PNP 45V 500mA 0.8W 160/400 100MHz TO92	0.037	0.029	0.027	0.025	0.023
BC327-40	PNP 45V 500mA 0.8W 250/600 100MHz TO92	0.037	0.029	0.027	0.025	0.023
BC328-40	PNP 25V 500mA 0.8W 250/600 100MHz TO92	0.037	0.029	0.027	0.025	0.023
BC337-16	NPN 45V 500mA 0.8W 100/250 100MHz TO92	0.039	0.031	0.028	0.026	0.024
BC337-25	NPN 45V 500mA 0.8W 160/400 100MHz TO92	0.041	0.033	0.030	0.028	0.026
BC337-40	NPN 45V 500mA 0.8W 250/600 100MHz TO92	0.037	0.029	0.027	0.025	0.023
BC338-40	NPN 25V 500mA 0.8W 250/600 100MHz TO92	0.038	0.030	0.028	0.025	0.024
BC517	DNP 30V 0.5A 0.5W Hfe>30000 220MHz TO-92	0.084	0.067	0.061	0.057	0.052
BC546	NPN 65V 100mA 0.5W 2dB	0.029	0.023	0.021	0.020	0.018
BC546B	NPN 65V 100mA 0.5W 200/450 300MHz TO92	0.025	0.020	0.018	0.017	0.016
BC547B	NPN 45V 100mA 0.5W 2dB	0.026	0.021	0.019	0.017	0.016
BC547C	NPN 45V 100mA 0.5W 420/800 300MHz TO92	0.025	0.020	0.018	0.017	0.016
BC548	NPN 30V 100mA 0.5W 2dB	0.027	0.021	0.019	0.018	0.017
BC549	NPN 30V 100mA 0.5W 1.2dB	0.029	0.023	0.021	0.019	0.018
BC549C	NPN 30V 100mA 0.5W 420/800 300MHz TO92	0.029	0.023	0.021	0.020	0.018
BC550B	NPN 50V 200mA 0.5W	0.029	0.023	0.021	0.020	0.018
BC550C	NPN 45V 100mA 0.5W 420/800 300MHz TO92	0.029	0.023	0.021	0.020	0.018
BC556	PNP 65V 100mA 0.5W 2dB	0.025	0.020	0.018	0.017	0.016
BC556B	PNP 65V 100mA 0.5W 220/475 200MHz TO92	0.025	0.020	0.018	0.017	0.016
BC557B	NPN 45V 100mA 0.5W 2dB	0.028	0.023	0.021	0.019	0.018
BC557C	PNP 45V 100mA 0.5W 420/800 200MHz TO92	0.025	0.020	0.018	0.017	0.016
BC559	NPN 30V 100mA 0.5W 1dB	0.036	0.028	0.026	0.024	0.022
BC559C	PNP 30V 100mA 0.5W 320/800 200MHz TO92	0.036	0.029	0.026	0.024	0.022
BC560B	PNP 50V 200mA 0.5W	0.036	0.029	0.026	0.024	0.022
BC560C	PNP 45V 100mA 0.5W 420/800 200MHz TO92	0.036	0.029	0.026	0.024	0.022
BC618	DNP 55V 1A 0.625W Hfe>10000 150MHz TO-92	0.048	0.038	0.035	0.032	0.03
BC637	NPN 80V 1A 0.8W 40/250 130MHz TO92					0.054
BC638	PNP 60V 1A 0.8W 40/250 50MHz TO92					0.054
BC639	NPN 80V 1A 0.8W 40/250 130MHz TO92	0.087	0.069	0.063	0.058	0.054
BC640	PNP 80V 1A 0.8W 40/250 50MHz TO92	0.098	0.078	0.072	0.066	0.061
Transistors BD,BDX		1-24	25-99	100+	500+	
BD137	NPN 45V 1.5A 8W	0.146	0.136	0.127	0.113	
BD138	PNP 45V 1.5A 8W	0.152	0.141	0.132	0.117	
BD139	NPN 80V 1.5A 8W 100 250MHz TO126	0.169	0.157	0.147	0.130	
BD140	PNP 80V 1.5A 8W 100 75MHz TO126	0.180	0.168	0.157	0.139	
BD235	NPN 60V 2A 25W TO126	0.255	0.238	0.222	0.196	
BD237	NPN 80V 2A 25W TO126	0.192	0.179	0.167	0.148	
BD238	PNP 80V 2A 25W TO126	0.255	0.238	0.222	0.196	

Transistors BD, BDX		1-24	25-99	100+	500+	
BD679	NPN D 80V 4A 40W 750 TO126					
BD680	PNP D 80V 4A 40W 750 TO126					
BD681	NPN D 100V 4A 40W 750 TO126	0.267	0.248	0.232	0.205	
BD682	PNP D 100V 4A 40W 750 TO126	0.228	0.212	0.198	0.175	
BDW93C	NPN D 100V 12A 80W	0.422	0.393	0.367	0.324	
BDW94C	PNP D 100V 12A 80W	0.436	0.406	0.379	0.336	
Transistors BF, BFG, BFR, BFY, BGY		1-24	25-99	100+	500+	
BF459	NPN 300V 100mA 6W	0.253	0.236	0.220	0.195	
BFG96	NPN 15V 100mA 0.5W 5.5GHz 11dB	0.293	0.272	0.253	0.236	
BFG97	NPN 20V 100mA 0.5W	0.392	0.365	0.341	0.301	
BFG135	NPN 25V 150mA 1W	0.749	0.697	0.651	0.576	
BFR90A	NPN 15V 25MA 0.18W 5GHz	0.329	0.305	0.284	0.265	
BFR91A	NPN 12V 35MA 0.3W 6GHz	0.288	0.267	0.248	0.232	
BFR93A	NPN 12V 35mA 0.25W 5GHz	0.149	0.138	0.128	0.120	
BFR96S	NPN 15V 100mA 0.5W 5.5GHz 11dB	0.304	0.282	0.262	0.245	
BFY90	NPN 15V 50mA 0.2W 1.4GHz	0.338	0.314	0.292	0.273	
BGY588/04	Hybrid m.550 MHz Gpmin 33.5dB Vsuppl 24V	27.454	25.461	23.690	22.140	
Transistors BU, BUT		1-24	25-99	100+	500+	
BU208D	NPN 1500/700V 8A 150W 0.55uS	1.572	1.390	1.209		
BU2508AF	NPN 1500/700V 8A 45W 0.6uS	1.399	1.237	1.076		
BU2525A	NPN 1500/800V 12A 125W 0.2uS	1.619	1.432	1.245		
BU2525AF	NPN 1500/800V 12A 45W 0.2uS	1.671	1.478	1.285		
BU326	NPN 900/400V 6A 110W	0.813	0.719	0.625		
BU406	NPN 400/200V 7A 60W	0.709	0.628	0.546		
BU406D		0.886	0.784	0.682		
BU426	NPN 800/375V 6A 114W	0.845	0.748	0.650		
BU426AF						
BU508A	NPN 1500/700V 8A 125W 0.55uS	0.996	0.881	0.766		
BU508AF	NPN 1500/700V 8A 60W 0.55uS	1.008	0.891	0.775		
BU508D	NPN 1500/700V 8A 125W 0.55uS	1.021	0.903	0.785		
BU508DF	NPN 1500/700V 8A 60W 0.7uS	1.021	0.904	0.786		
BUT11A Philips	NPN 1000/450V 5A 100W	0.397	0.351	0.336	0.305	
BUT11AF	NPN 1000/450V 5A 20W 0.8uS	0.715	0.633	0.550		
Transistors MJE, MPSA		1-24	25-99	100+	500+	
MJE13005	NPN 400V 4A TO220	0.281	0.249	0.216		
MJE13005 SAM	NPN 400V 4A TO220	0.276	0.244	0.212		
MJE13007	NPN 400V 8A TO220	0.443	0.392	0.341		
MJE13009	NPN 400V 12A TO220	0.624	0.552	0.480		
MJE340	NPN 300V 0.5A TO225	0.246	0.218	0.195		
MJE350	PNP 300V 0.5A TO225	0.238	0.211	0.189		
MPSA13	DNPN 30V 0.5A 0.625W 125MHz TO-92	0.062	0.056	0.047	0.044	
MPSA42	NPN 300V 0.5A 0.625W 50MHz TO-92	0.066	0.060	0.051	0.047	
MPSA92	PNP 300V 0.5A 0.625W 50MHz TO-92	0.053	0.048	0.041	0.038	
Transistors TIP		1-24	25-99	100+	500+	
TIP121	NPN 80V 5A 65W	0.287	0.255	0.234	0.213	
TIP122	NPN 100V 5A 65W	0.254	0.225	0.207	0.188	
TIP126	PNP 80V 5A 65W	0.287	0.255	0.234	0.213	
TIP127	PNP 100V 5A 65W	0.254	0.225	0.207	0.188	
Transistors ZETEX E-Line~TO92		1-24	1-24	25-99	100+	500+
ZTX320	NPN 30/15V 600MHz 6 dB 1.7pF 300 mW CBE	0.144	0.131	0.115	0.106	
ZTX958	PNP 400/400V 0.5A hfe 100 Ucesat 0.40V CBE	0.388	0.353	0.310	0.287	
FXT657	NPN 300/300 0.5A hfe 40 Ucesat 0.5V BCE	0.244	0.222	0.195	0.180	
ZTX658	NPN 400/400V 0.5A hfe 50 Ucesat 0.5V CBE	0.244	0.222	0.195	0.180	
ZTX712	PNP 80/60 0.8A hfe 5K Ucesat 1.25V CBE	0.189	0.172	0.151	0.140	
FXT450	NPN 60/45V 1A hfe 100 Ucesat 0.25V BCE	0.144	0.131	0.115	0.107	
FXT550	PNP 60/45V 1A hfe 100 Ucesat 0.25V BCE	0.153	0.139	0.122	0.113	
FXT603	NPN DARL100/80 1A hfe 5K Ucesat 1V BCE	0.244	0.222	0.195	0.180	
ZTX451	NPN 80/60V 1A hfe 50 Ucesat 0.35V CBE	0.184	0.168	0.148	0.137	
ZTX453	NPN 120/100V 1A hfe 40 Ucesat 0.7V CBE	0.194	0.176	0.155	0.143	
ZTX550	PNP 60/45V 1A hfe 100 Ucesat 0.25V CBE	0.194	0.176	0.155	0.143	

Transistors ZETEX E-Line~TO92		1-24	25-99	100+	500+
ZTX553	PNP 120/100V 1A hfe 40 Ucesat 0.25V CBE	0.194	0.176	0.155	0.143
ZTX704	PNP DARL120/100V 1A hfe 3K Ucesat 1.3V CBE	0.252	0.230	0.202	0.187
ZTX705	PNP DARL140/120V 1A hfe3K Ucesat1.3V CBE	0.252	0.230	0.202	0.187
ZTX600	NPN DARL160/140V 1A hfe 2K 140 MHz CBE	0.244	0.222	0.195	0.180
ZTX601	NPN DARL180/160V 1A hfe2K Ucesat1.2V CBE	0.244	0.222	0.195	0.180
ZTX603	NPN DARL100/80V 1A hfe 5K Ucesat 1V CBE	0.244	0.222	0.195	0.180
FXT749	PNP 35/25 2A hfe 100 Ucesat 0.5V BCE	0.252	0.230	0.202	0.187
ZTX749	PNP 35/25 2A hfe 100 Ucesat 0.5V BCE	0.252	0.230	0.202	0.187
ZTX690B	NPN 45/45V 2A hfe 400 Ucesat 0.5V CBE	0.270	0.246	0.216	0.200
ZTX790A	PNP 50/40V 2A hfe 200 Ucesat 0.75V CBE	0.280	0.255	0.224	0.207
FXT653	NPN 120/100 2A hfe 100 Ucesat0.5V BCE	0.244	0.222	0.195	0.180
ZTX653	NPN 120/100V 2A hfe 100 Ucesat 0.5V CBE	0.244	0.222	0.195	0.180
FXT753	PNP 120/100V 2A hfe 100 Ucesat 0.5V BCE	0.252	0.230	0.202	0.187
ZTX753	PNP 120/100V 2A hfe 100 Ucesat 0.5V CBE	0.252	0.230	0.202	0.187
ZTX857	NPN 330/300V 3A hfe 100 Ucesat 0.25V CBE	0.378	0.345	0.303	0.280
ZTX869	NPN 60/25V 5A hfe 250 Ucesat 0.22V CBE	0.388	0.353	0.310	0.287
ZTX951	PNP 100/60V 4A hfe 100 Ucesat 0.30V CBE	0.388	0.353	0.310	0.287
ZTX1051A	NPN 150/40 4A hfe 300 Ucesat 0.21V CBE	0.307	0.279	0.245	0.227
ZTX968	PNP 15/12V 4.5A hfe 300 Ucesat 0.30V CBE	0.388	0.353	0.310	0.287
ZTX851	NPN 150/60V 5A hfe 100 Ucesat 0.25V CBE	0.378	0.345	0.303	0.280
Transistors FET ZETEX		1-24	25-99	100+	500+
ZVNL120A	N-MOSFET 200V 0.18A 10 Ohm UGS 0.5/1.5V	0.293	0.267	0.234	0.217
BS170P	N MOSFET 60V 0.27A 5 Ohm VGS 0.8/3V	0.219	0.199	0.175	0.162
ZVN3306A	N MOSFET 60V 0.27A 5 Ohm VGS 0.8/2.4V	0.209	0.191	0.167	0.155
ZVN4210A	N MOSFET 100V 0.45A 1.8 Ohm VGS 0.8/2.4V	0.293	0.267	0.234	0.217
ZVP3310A	P-MOSFET 100V 0.14A 20 Ohm UGS 1.5/4.5V	0.226	0.205	0.180	0.167
ZVP4424A	P-MOSFET 100V 0.14A 20 Ohm UGS 1.5/4.5V	0.597	0.544	0.478	0.442
Transistors FET		1-24	25-99	100+	500+
BS107	NDMOS200V 0.12A 0.25W 10/15nS 28 Ohm TO92	0.167	0.155	0.145	0.128
BS108	NDMOS200V 0.23A 10/30nS	0.178	0.166	0.155	0.137
BS250	PDMOS45V 0.25A 0.83W 4/10nS 14 Ohm TO92	0.223	0.208	0.194	0.172
J175	PJFET 30V 125 Ohm 15/30nS	0.145	0.135	0.126	0.112
BF245C	NJFET 30V	0.250	0.233	0.218	0.193
2N4392	NJFET 40V 60 Ohm 1.8W	0.293	0.272	0.254	0.225
PN4393	NJFET 40V 100 Ohm 0.2W	0.234	0.218	0.203	0.180
BF960	NMOS 20V 225mW 2.8dB/800MHz	0.226	0.210	0.196	0.174
BF961	NMOS 20V 200mW 1.8dB/200MHz	0.280	0.261	0.243	0.215
Power MOS FET		1-24	25-99	100-499	500+
2SK2540T ROHM	HRT N 100V 10A	0.714	0.620	0.576	0.549
BUK454-500B	N 500V 3.3A 75W 2.8R TO-220	0.925	0.819	0.712	
BUK456-800A	N 800V 4A 125W 3.0R TO-220	1.568	1.387	1.206	
BUK456-1000B	N 1000V 3.1A 125W 5.0R TO-220	2.718	2.405	2.091	
BUZ11	N 50V 36A 120W 0.04R TO-220	0.499	0.444	0.396	0.370
BUZ21	N 100V 21A 110W 0.1R TO-220	0.691	0.611	0.531	
BUZ31	N 200V 13.5A 75W 0.2R TO-220	1.131	1.001	0.870	
BUZ71	N 50V 16A 40W 0.1R TO-220	0.341	0.303	0.270	0.253
BUZ74	N 500V 2.4A 40W 3.0R TO-220	0.653	0.578	0.502	
BUZ341	N 200V 33A 170W 0.07R TO-218	3.102	2.744	2.386	
IRF350	N 400V 15A 150W 0.30R TO-3	8.390	7.875	7.360	
IRF530	N 100V 14A 75W 0.16R TO-220	0.400	0.356	0.317	0.296
IRF540	N 100V 30A 150W 0.077R TO-220	0.520	0.462	0.412	0.385
IRF630	N 200V 10A 100W 0.4R TO-220	0.399	0.355	0.316	0.295
IRF640	N 200V 18A 125W 0.18R TO-220	0.472	0.419	0.374	
IRF730	N 400V 5.5A 74W 1.0R TO-220	0.473	0.420	0.375	0.350
IRF740	N 400V 10A 125W 0.55R TO-220	0.660	0.584	0.508	
IRF830	N 500V 4.5A 75W 1.5R TO-220	0.469	0.417	0.372	0.347
IRF840	N 500V 8.0A 75W 0.85R TO-220	0.607	0.537	0.467	
IRF9530	P 100V 10.5A 75W 0.3R TO-220	0.546	0.483	0.420	
Power IGBT Transistors		1-24	25-99	100+	
BUP202	1000V 12A 100W UCE SAT 3.3V/ 5A	3.239	2.974	2.655	
BUP203	1000V 21A 165W UCE SAT 3.3V/10A	2.404	2.207	1.970	
BUP304	1000V 35A 310W UCE SAT 3.3V/15A	4.824	4.661	4.088	

Diodes up to 0.3A		1-9	10-299	300-999	1000+	
1N4148	100 V 150 mA 4nS	0.0098	0.0082	0.0073	0.0061	
1N4148 ROHM	100 V 150 mA 4nS	0.0111	0.0094	0.0083	0.0069	
1N4150	50 V 200 mA 4nS	0.0196	0.0153	0.0142	0.0109	
1N4448	100 V 150 mA 4nS	0.0144	0.0112	0.0104	0.0080	
BAT42	30V 200mA(500mA) 7pF 5ns Schottky	0.0518	0.0437	0.0388	0.0324	
Diodes up to 1A		1-9	10-99	100-999	1000+	5000+
1N4004	400 V 1 A	0.0096	0.0075	0.0066	0.0059	0.0056
1N4007	1000 V 1 A	0.0100	0.0079	0.0069	0.0061	0.0058
1N4007G	1000 V 1 A	0.0463	0.0363	0.0317	0.0282	0.0269
1N5819 MB	40 V 1 A Schottky	0.0930	0.0840	0.0710	0.0660	
1N5819	40 V 1 A Schottky	0.0330	0.0300	0.0250	0.0230	
BA159	600 V 1 A 300nS Fast	0.0118	0.0107	0.0091	0.0084	
FR102	100 V 1 A 150nS Fast	0.0108	0.0098	0.0084	0.0077	
FR104	400 V 1 A 150nS Fast	0.0111	0.0101	0.0086	0.0079	
FR106	800 V 1 A 500nS Fast	0.0113	0.0103	0.0087	0.0081	
FR107	1000 V 1 A 500nS Fast	0.0114	0.0104	0.0088	0.0082	
HER107	800V 1A 70ns High Efficiency, Fast	0.0230	0.0210	0.0180	0.0160	
SF15	300V 1A 35nS Super Fast	0.0270	0.0240	0.0200	0.0190	
Diodes up to 5A		1-9	10-99	100-499	500+	2000+
RL202	100V 2A	0.0230	0.0210	0.0190	0.0180	0.0167
RL204	400V 2A	0.0260	0.0240	0.0220	0.0200	0.0189
RL207	1000V 2A	0.0270	0.0250	0.0230	0.0210	0.0196
1N5400	50 V 3 A	0.0285	0.0256	0.0236	0.0220	0.0203
1N5404	400 V 3 A	0.0290	0.0261	0.0240	0.0223	0.0207
1N5407	800 V 3 A	0.0293	0.0264	0.0243	0.0226	0.0209
1N5408	1000 V 3 A	0.0296	0.0266	0.0245	0.0228	0.0211
1N5820	20 V 3 A Schottky	0.1260	0.1140	0.0970	0.0900	
1N5822	40 V 3 A Schottky	0.1270	0.1150	0.0980	0.0910	
FR302	100 V 3 A 150nS Fast	0.0474	0.0430	0.0365	0.0338	
FR304	400 V 3 A 150nS Fast	0.0482	0.0437	0.0372	0.0344	
FR307	1000 V 3 A 500nS Fast	0.0496	0.0450	0.0382	0.0354	
HER307	800V 2A 70ns High Efficiency, Fast	0.1020	0.0920	0.0780	0.0730	
SF35	300V 3A 35nS Super Fast DO-201AD	0.0950	0.0860	0.0730	0.0680	
Diodes above 5A		1-9	10-99	100-499	500+	
FR602	100 V 6 A 150nS	0.125	0.107	0.103	0.089	
FR604	400 V 6 A 150nS	0.126	0.108	0.104	0.090	
SB540	40V 5A Schottky	0.419	0.359	0.344	0.299	
Bridge Rectifiers		1-9	10-99	100-499	500+	2000+
DB104	400V 1A VFM 1.1V/1A IFM 50A IR 10uA DIL	0.144	0.128	0.118	0.108	0.103
DB107	1000V 1A VFM 1.1V/1A IFM 50A IR 10uA DIL	0.152	0.136	0.125	0.114	0.109
W04M	400V 1.5A VFM 1V/1A IFM 50A IR 10uA	0.084	0.073	0.070	0.066	0.062
W08M	800V 1.5A VFM 1V/1A IFM 50A IR 10uA	0.087	0.078	0.071	0.065	0.062
2W04M	400V 2A VFM 1V/1A IFM 50A IR 10uA	0.093	0.083	0.076	0.070	0.066
KBP200(KBP005)	50V 2A VFM 1V/1A IFM 50A IR 10uA SIL	0.115	0.102	0.094	0.086	0.082
KBP204(KBP04)	400V 2A VFM 1V/1A IFM 50A IR 10uA SIL	0.111	0.099	0.091	0.083	0.079
KBP208(KBP08)	800V 2A VFM 1V/1A IFM 50A IR 10uA SIL	0.113	0.101	0.093	0.085	0.081
		1-4	5-24	25-99	100+	
KBPC304(KBPC104)	400V 3A VFM 1V/1.5A IFM 50A IR 10uA	0.154	0.133	0.124	0.118	
KBL404	400V 4A VFM 1V/3A IFM 150A IR 10uA SIL	0.278	0.241	0.224	0.214	
KBPC604	400V 6A VFM 1V/3A IFM 125A IR 10uA	0.266	0.231	0.215	0.205	
KBPC608	800V 6A VFM 1V/3A IFM 125A IR 10uA	0.275	0.239	0.222	0.211	
KBU804	400V 8A VFM 1V/4A IFM 150A IR 10uA SIL	0.268	0.233	0.217	0.206	
KBPC2502	200V 25A VFM 1.1V/12.5A IFM 300A IR 10uA	0.841	0.731	0.679	0.647	
KBPC2504	400V 25A VFM 1.1V/12.5A IFM 300A IR 10uA	0.848	0.737	0.685	0.652	
KBPC3504	400V 35A VFM 1.1V/17.5A IFM 400A IR 10uA	0.945	0.821	0.763	0.727	
KBPC3508	800V 35A VFM 1.1V/17.5A IFM 400A IR 10uA	0.952	0.828	0.769	0.733	

Diacs		1-24	25-99	100-499	500+	
DB3	32V 2A	0.051	0.048	0.045	0.042	
Triacs		1-24	25-99	100-499	500+	
BT136-500	500V 4A	0.442	0.392	0.350	0.327	
BT138-800F	TO220AB 800V 12A Igt 25mA	0.567	0.504	0.450	0.420	
BT139X-800E	TO220 isolated 800V 16A Igt 10mA	0.871	0.775	0.691	0.645	
BTA06-600	TO220AB isol. 600V 6A Igt 35mA	0.497	0.441	0.394	0.368	
BTA08-600	TO220AB isol. 600V 8A Igt 35mA	0.585	0.520	0.464	0.434	
BTA12-600	TO220AB isol. 600V 12A Igt 50mA	0.656	0.583	0.520	0.486	
BTA16-600	TO220AB isol. 600V 16A Igt 50mA	0.814	0.724	0.645	0.603	
BTA25-600	RD91 isol.600V 30A Igt 50mA	4.234	3.615	3.257		
BTA26-600	TOP3 isol.600V 25A Igt 50mA	2.123	1.813	1.633		
BTA40-700	RD91 isol.700V 40A Igt 50mA	5.182	4.424	3.986		
BTA41-600	TOP3 isol.600V 40A Igt 50mA	3.134	2.676	2.411		
Zener Diodes 500 mW DO35		1-9	10-99	100-999	1000-4999	5000+
BZX55(79)C2V4	2.4V 500mW	0.016	0.015	0.013	0.012	0.011
BZX55(79)C2V7	2.7V 500mW	0.027	0.025	0.023	0.021	0.019
BZX55(79)C3V0	3.0V 500mW	0.027	0.025	0.023	0.021	0.019
BZX55(79)C3V3	3.3V 500mW	0.016	0.015	0.014	0.012	0.011
BZX55(79)C3V6	3.6V 500mW	0.027	0.025	0.023	0.021	0.019
BZX55(79)C3V9	3.9V 500mW	0.020	0.019	0.017	0.015	0.014
BZX55(79)C4V3	4.3V 500mW	0.016	0.015	0.013	0.012	0.011
BZX55(79)C4V7	4.7V 500mW	0.015	0.014	0.013	0.012	0.011
BZX55(79)C5V1	5.1V 500mW	0.015	0.014	0.013	0.012	0.011
BZX55(79)C5V6	5.6V 500mW	0.016	0.015	0.014	0.012	0.011
BZX55(79)C6V2	6.2V 500mW	0.015	0.014	0.013	0.012	0.011
BZX55(79)C6V8	6.8V 500mW	0.016	0.015	0.013	0.012	0.011
BZX55(79)C7V5	7.5V 500mW	0.016	0.015	0.014	0.012	0.011
BZX55(79)C8V2	8.2V 500mW	0.016	0.015	0.013	0.012	0.011
BZX55(79)C9V1	9.1V 500mW	0.016	0.015	0.014	0.012	0.011
BZX55(79)C10	10V 500mW	0.015	0.014	0.013	0.012	0.011
BZX55(79)C11	11V 500mW	0.016	0.015	0.014	0.012	0.011
BZX55(79)C12	12V 500mW	0.015	0.014	0.013	0.012	0.011
BZX55(79)C13	13V 500mW	0.016	0.015	0.013	0.012	0.011
BZX55(79)C15	15V 500mW	0.015	0.014	0.013	0.012	0.011
BZX55(79)C16	16V 500mW	0.016	0.015	0.014	0.012	0.011
BZX55(79)C18	18V 500mW	0.016	0.015	0.013	0.012	0.011
BZX55(79)C20	20V 500mW	0.016	0.015	0.014	0.012	0.011
BZX55(79)C22	22V 500mW	0.016	0.015	0.014	0.012	0.011
BZX55(79)C24	15V 500mW	0.016	0.015	0.014	0.012	0.011
BZX55(79)C27	27V 500mW	0.027	0.025	0.023	0.021	0.019
BZX55(79)C30	30V 500mW	0.027	0.025	0.023	0.021	0.019
BZX55(79)C33	33V 500mW	0.016	0.015	0.013	0.012	0.011
BZX55(79)C36	36V 500mW	0.027	0.025	0.023	0.021	0.019
BZX55(79)C39	39V 500mW	0.027	0.025	0.023	0.021	0.019
BZX55(79)C43	43V 500mW	0.027	0.025	0.023	0.021	0.019
BZX55(79)C47	47V 500mW	0.027	0.025	0.023	0.021	0.019
BZX55(79)C51	51V 500mW	0.027	0.025	0.023	0.021	0.019
BZX55(79)C56	56V 500mW	0.027	0.025	0.023	0.021	0.019
BZX55(79)C62	62V 500mW	0.027	0.025	0.023	0.021	0.019
BZX55(79)C68	68V 500mW	0.027	0.025	0.023	0.021	0.019
BZX55(79)C75	75V 500mW	0.027	0.025	0.023	0.021	0.019
ZD10V 0.5W ROHM	10V 500mW DO-34	0.022	0.020	0.019	0.017	0.015
ZD12V 0.5W ROHM	12V 500mW DO-34	0.024	0.023	0.021	0.019	0.017
ZD15V 0.5W ROHM	15V 500mW DO-34	0.026	0.025	0.023	0.020	0.018
ZD2.7V 0.5W ROHM	2.7V 500mW DO-34	0.028	0.026	0.024	0.021	0.019
ZD24V 0.5W ROHM	24V 500mW DO-34	0.028	0.026	0.024	0.021	0.019
ZD3.0V 0.5W ROHM	3V 500mW DO-34	0.026	0.025	0.023	0.020	0.018
ZD3.3V 0.5W ROHM	3.3V 500mW DO-34	0.026	0.025	0.023	0.020	0.018
ZD3.6V 0.5W ROHM	3.6V 500mW DO-34	0.026	0.025	0.023	0.020	0.018
ZD3.9V 0.5W ROHM	3.9V 500mW DO-34	0.026	0.025	0.023	0.020	0.018
ZD4.7V 0.5W ROHM	4.7V 500mW DO-34	0.022	0.020	0.019	0.017	0.015
ZD5.1V 0.5W ROHM	5.1V 500mW DO-34	0.021	0.020	0.018	0.016	0.015
ZD5.6V 0.5W ROHM	5.6V 500mW DO-34	0.021	0.020	0.018	0.016	0.015
ZD6.2V 0.5W ROHM	6.2V 500mW DO-34	0.021	0.020	0.018	0.016	0.015

Zener Diodes 500 mW DO35			1-9	10-99	100-999	1000-4999	5000+
ZD6.8V 0.5W ROHM		6.8V 500mW DO-34	0.021	0.020	0.018	0.016	0.015
ZD7.5V 0.5W ROHM		7.5V 500mW DO-34	0.021	0.020	0.018	0.016	0.015
ZD9.1V 0.5W ROHM		9.1V 500mW DO-34	0.021	0.020	0.018	0.016	0.015
Zener Diodes 1.3 W			1-9	10-99	100-499	500+	
1N4728		3.3V 1.3W 5%	0.049	0.045	0.039	0.037	
1N4729		3.6V 1.3W 5%	0.058	0.053	0.046	0.043	
1N4730		3.9V 1.3W 5%	0.053	0.049	0.043	0.039	
1N4731		4.3V 1.3W 5%	0.058	0.053	0.047	0.043	
1N4732	/ BZV85-C4V7	4.7V 1.3W 5%	0.034	0.031	0.027	0.025	
1N4733		5.1V 1.3W 5%	0.045	0.041	0.036	0.034	
1N4734	/ BZV85-C5V6	5.6V 1.3W 5%	0.034	0.031	0.027	0.025	
1N4735		6.2V 1.3W 5%	0.049	0.045	0.039	0.037	
1N4736		6.8V 1.3W 5%	0.053	0.049	0.043	0.039	
1N4737		7.5V 1.3W 5%	0.053	0.048	0.043	0.039	
1N4738		8.2V 1.3W 5%	0.049	0.045	0.039	0.037	
1N4739		9.1V 1.3W 5%	0.049	0.045	0.039	0.037	
1N4740		10V 1.3W 5%	0.049	0.045	0.039	0.037	
1N4741		11V 1.3W 5%	0.053	0.048	0.043	0.039	
1N4742	/ BZV85-C12	12V 1.3W 5%	0.034	0.031	0.027	0.025	
1N4743		13V 1.3W 5%	0.049	0.045	0.039	0.037	
1N4744		15V 1.3W 5%	0.050	0.045	0.040	0.037	
1N4745		16V 1.3W 5%	0.053	0.048	0.042	0.039	
1N4746		18V 1.3W 5%	0.049	0.045	0.039	0.037	
1N4747		20V 1.3W 5%	0.053	0.048	0.042	0.039	
1N4748		22V 1.3W 5%	0.051	0.046	0.041	0.038	
1N4749		24V 1.3W 5%	0.049	0.045	0.039	0.037	
1N4750		27V 1.3W 5%	0.051	0.047	0.041	0.038	
1N4751		30V 1.3W 5%	0.053	0.048	0.043	0.039	
1N4752		33V 1.3W 5%	0.049	0.045	0.039	0.037	
1N4753		36V 1.3W 5%	0.049	0.045	0.039	0.037	
1N4754		39V 1.3W 5%	0.049	0.045	0.039	0.037	
1N4755		43V 1.3W 5%	0.053	0.048	0.042	0.039	
1N4756		47V 1.3W 5%	0.053	0.049	0.043	0.040	
1N4757		51V 1.3W 5%	0.059	0.053	0.047	0.043	
1N4758		56V 1.3W 5%	0.053	0.049	0.043	0.040	
1N4759		62V 1.3W 5%	0.049	0.045	0.039	0.037	
1N4760		68V 1.3W 5%	0.053	0.049	0.043	0.040	
1N4761		75V 1.3W 5%	0.051	0.047	0.041	0.038	
1N4762		82V 1.3W 5%	0.049	0.045	0.039	0.037	
1N4764		100V 1.3W 5%	0.073	0.066	0.058	0.054	
LCD Matrix Modules			1-4	5-24	25-99	100+	
AC-162BYA-50-H		16X2 LCD module STN 85.0x29.5mm	5.856	5.376	5.088	4.800	
AC-162BYILY-50		16X2 LCD module STN 85.0x29.5mm, BACKLIGHT	7.902	7.254	6.865	6.477	
AC-162EYILY-50		16X2 LCD module STN 122.0x44mm, BACKLIGHT	13.914	12.773	12.089	11.405	
AC-162EYA-50		16X2 LCD module STN 122.0x44mm	10.135	9.304	8.806	8.307	
AC-202AYILY-70		20X2 LCD module STN 116.0x37mm, BACKLIGHT	11.509	10.566	10.000	9.434	
AC-202AYA-70		20X2 LCD module STN 116.0x37mm	8.589	7.885	7.462	7.040	
AC-204AYILY-50		20X4 LCD module STN 98.0x60mm, BACKLIGHT	17.349	15.927	15.074	14.221	
AC-204AYA-50		20X4 LCD module STN 98.0x60mm	13.399	12.300	11.641	10.982	
LCD Graphic Modules			1-9				
AG-320240 A1FICW54		320x240 FSTN CCFL B/L GRAPH+INV, CON	91.520				
AG-240128BFCW30		240x128 FSTN CCFL B/L GRAPH+INV, CON	76.505				

LCD Matrix Modules

AC-162B * 16 Chars X 2 Line 1/16 Duty

FEATURE :

1. Construction : TN / STN LCD panel, Bezel, Zebra and PCB.
2. Optional Edge / Array LED or EL back-light.
3. Controller : KS0066U or Equivalent.
4. 5V or 3.3V single power input. Built-in DC/DC converter while using 3.3V power input.
5. Normal / Extended temperature type.

ELECTRICAL CHARACTERISTICS :

Item	Sym.	Condition	Typ. Value	Unit.
LCD Driving Voltage	VDD-V0	25 c	5.0	V
Supply Current	IDD	VDD=5.0V	1.0	mA

INTERFACE :

1	2	3	4	5	6	7	8	9	10	11	12	13	14	15	16
VSS	VDD	VO	RS	R/W	E	DB0	DB1	DB2	DB3	DB4	DB5	DB6	DB7	LEDA	LEDK

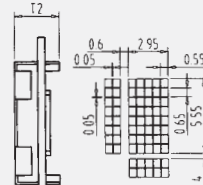
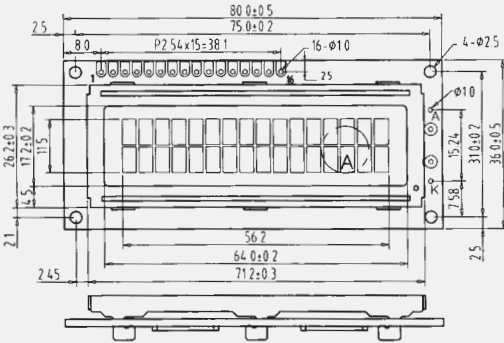

THICKNESS:

VERSION	T1	T2
EL & NO BACKLIGHT	4.9±0.3	10.0Max
EDGE BACK LIGHT	6.0±0.3	11.0Max
LED BACKLIGHT	9.4±0.3	14.5Max

AC-162E * 16 Chars X 2 Line 1/16 Duty

FEATURE :

1. Construction : HTN / STN LCD panel, Bezel, Zebra and PCB.
2. Optional LED or EL back-light.
3. Controller : KS0066U or Equivalent.
4. 5V or 3.3V single power input. Built-in DC/DC converter while using 3.3V power input.
5. Normal / Extended temperature type.

ELECTRICAL CHARACTERISTICS :

Item	Sym.	Condition	Typ. Value	Unit.
LCD Driving Voltage	VDD-V0	25 c	5.0	V
Supply Current	IDD	VDD=5.0V	1.5	mA

INTERFACE :

1	2	3	4	5	6	7	8	9	10	11	12	13	14	15	16
VSS	VDD	VO	RS	R/W	E	DB0	DB1	DB2	DB3	DB4	DB5	DB6	DB7	LEDA	LEDK

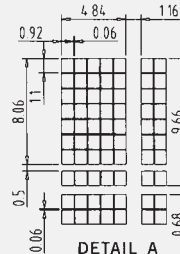
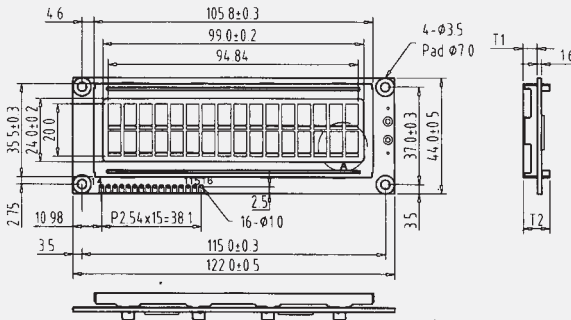

THICKNESS:

VERSION	T1	T2
EL & NO BACKLIGHT	5.4±0.3	10.5Max
LED BACKLIGHT	9.5±0.3	14.5Max

LCD Matrix Modules

AC-202A * 20 Chars X 2 Line 1/16 Duty

FEATURE :	ELECTRICAL CHARACTERISTICS :																																			
1. Construction : STN LCD panel, Bezel, Zebra and PCB. 2. Optional Array / Edge LED or EL back-light. 3. Controller : KS0066U or Equivalent. 4. 5V or 3.3V single power input. Built-in DC/DC converter while using 3.3V power input. 5. Normal / Extended temperature type.	<table border="1"> <thead> <tr> <th>Item</th> <th>Sym.</th> <th>Condition</th> <th>Typ. Value</th> <th>Unit.</th> </tr> </thead> <tbody> <tr> <td>LCD Driving Voltage</td> <td>VDD-VO</td> <td>25°C</td> <td>5.0</td> <td>V</td> </tr> <tr> <td>Supply Current</td> <td>IDD</td> <td>VDD=5.0V</td> <td>1.2</td> <td>mA</td> </tr> </tbody> </table>	Item	Sym.	Condition	Typ. Value	Unit.	LCD Driving Voltage	VDD-VO	25°C	5.0	V	Supply Current	IDD	VDD=5.0V	1.2	mA																				
	Item	Sym.	Condition	Typ. Value	Unit.																															
	LCD Driving Voltage	VDD-VO	25°C	5.0	V																															
	Supply Current	IDD	VDD=5.0V	1.2	mA																															
	INTERFACE :																																			
<table border="1"> <thead> <tr> <th>1</th> <th>2</th> <th>3</th> <th>4</th> <th>5</th> <th>6</th> <th>7</th> <th>8</th> <th>9</th> <th>10</th> <th>11</th> <th>12</th> <th>13</th> <th>14</th> <th>15</th> <th>16</th> </tr> </thead> <tbody> <tr> <td>VSS</td> <td>VDD</td> <td>VO</td> <td>RS</td> <td>R/W</td> <td>E</td> <td>DB0</td> <td>DB1</td> <td>DB2</td> <td>DB3</td> <td>DB4</td> <td>DB5</td> <td>DB6</td> <td>DB7</td> <td>LEDA</td> <td>LEDK</td> </tr> </tbody> </table>					1	2	3	4	5	6	7	8	9	10	11	12	13	14	15	16	VSS	VDD	VO	RS	R/W	E	DB0	DB1	DB2	DB3	DB4	DB5	DB6	DB7	LEDA	LEDK
1	2	3	4	5	6	7	8	9	10	11	12	13	14	15	16																					
VSS	VDD	VO	RS	R/W	E	DB0	DB1	DB2	DB3	DB4	DB5	DB6	DB7	LEDA	LEDK																					

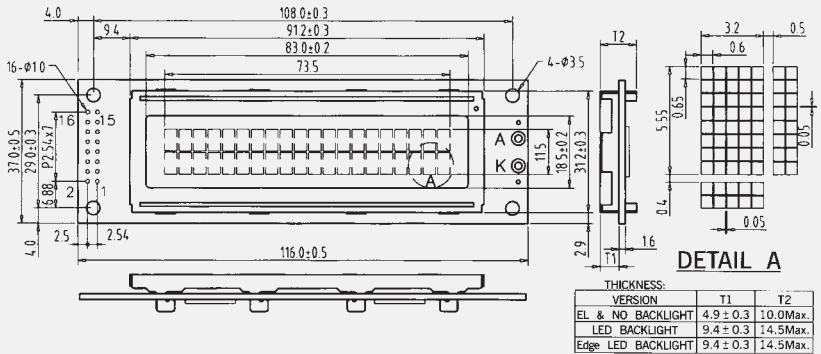

AC-204A * 20 Chars X 4 Line 1/16 Duty

FEATURE :	ELECTRICAL CHARACTERISTICS :																																			
1. Construction : STN LCD panel, Bezel, Zebra and PCB. 2. Optional LED or EL back-light. 3. Controller : KS0066U or Equivalent. 4. 5V or 3.3V single power input. Built-in DC/DC converter while using 3.3V power input. 5. Normal / Extended temperature type.	<table border="1"> <thead> <tr> <th>Item</th> <th>Sym.</th> <th>Condition</th> <th>Typ. Value</th> <th>Unit.</th> </tr> </thead> <tbody> <tr> <td>LCD Driving Voltage</td> <td>VDD-VO</td> <td>25°C</td> <td>5.0</td> <td>V</td> </tr> <tr> <td>Supply Current</td> <td>IDD</td> <td>VDD=5.0V</td> <td>1.5</td> <td>mA</td> </tr> </tbody> </table>	Item	Sym.	Condition	Typ. Value	Unit.	LCD Driving Voltage	VDD-VO	25°C	5.0	V	Supply Current	IDD	VDD=5.0V	1.5	mA																				
	Item	Sym.	Condition	Typ. Value	Unit.																															
	LCD Driving Voltage	VDD-VO	25°C	5.0	V																															
	Supply Current	IDD	VDD=5.0V	1.5	mA																															
	INTERFACE :																																			
<table border="1"> <thead> <tr> <th>1</th> <th>2</th> <th>3</th> <th>4</th> <th>5</th> <th>6</th> <th>7</th> <th>8</th> <th>9</th> <th>10</th> <th>11</th> <th>12</th> <th>13</th> <th>14</th> <th>15</th> <th>16</th> </tr> </thead> <tbody> <tr> <td>VSS</td> <td>VDD</td> <td>VO</td> <td>RS</td> <td>R/W</td> <td>E</td> <td>DB0</td> <td>DB1</td> <td>DB2</td> <td>DB3</td> <td>DB4</td> <td>DB5</td> <td>DB6</td> <td>DB7</td> <td>LEDA</td> <td>LEDK</td> </tr> </tbody> </table>					1	2	3	4	5	6	7	8	9	10	11	12	13	14	15	16	VSS	VDD	VO	RS	R/W	E	DB0	DB1	DB2	DB3	DB4	DB5	DB6	DB7	LEDA	LEDK
1	2	3	4	5	6	7	8	9	10	11	12	13	14	15	16																					
VSS	VDD	VO	RS	R/W	E	DB0	DB1	DB2	DB3	DB4	DB5	DB6	DB7	LEDA	LEDK																					

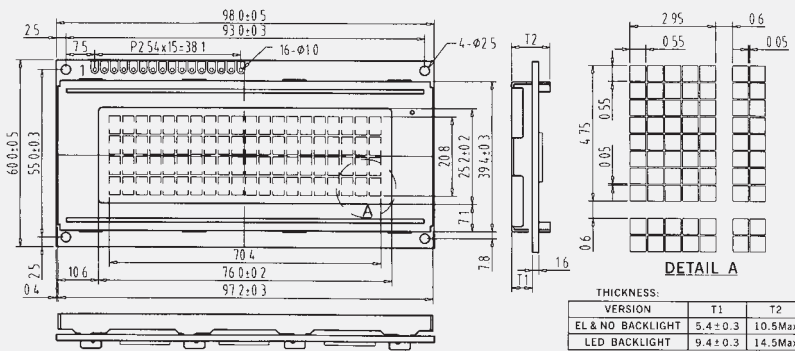

LCD Graphic Modules

AG-240128G * 240 x 128 dots 1/128 Duty

FEATURE
1. Construction : STN/FSTN LCD, Bezel, Heat Seal, Zebra and PCB.
2. Optional LED/EL/CCFL back-light.
3. Built-in Controller/Pure Driver
4. 5V single power input. Built-in DC/DC converter for LCD driving.
5. Normal / Extended temperature type.

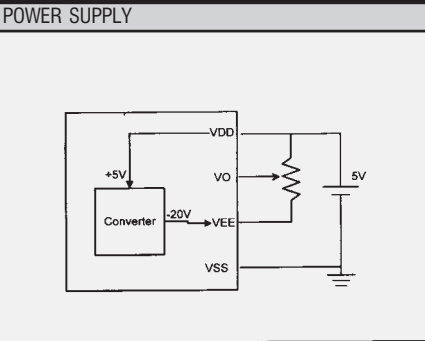

ELECTRICAL CHARACTERISTICS

Item	Symbol	Condition	Typ. Value	Unit.
LCD Driving Voltage	VDD-VO	25°C	18.9	V
Supply Current (Controller)	IDD	VDD=5.0V	25	mA
Supply Current (Driver)	IDD	VDD=5.0V	15	mA

BUILT-IN CONTROLLER

1	2	3	4	5	6	7	8	9	10
VSS	VDD	VO	C/D	/RD	/WR	DB0	DB1	DB2	DB3
11	12	13	14	15	16	17	18	19	20
DB4	DB5	DB6	DB7	/CE	/RES	VEE	MD2	FS	NC

PURE DRIVER

1	2	3	4	5	6	7	8	9	10
FLM	CP	LP	M	VDD	VSS	VEE	DO	D1	D2
11	12	13	14	15					
D3	VO	/DISPOFF	NC	NC					

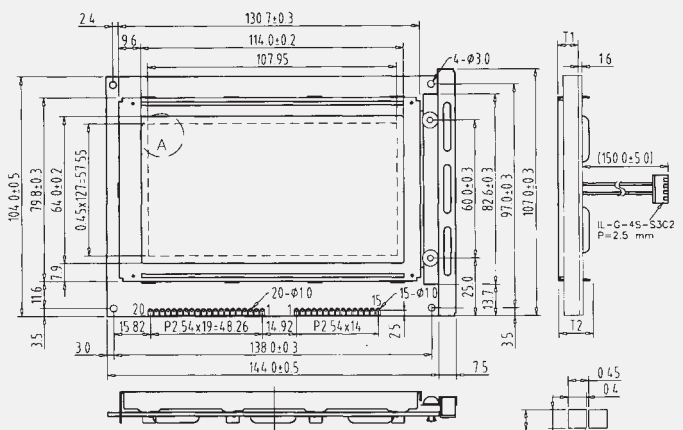
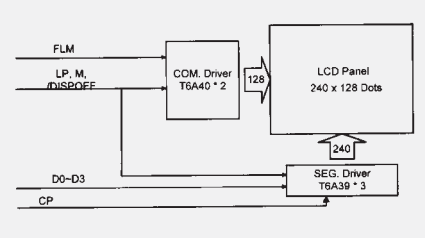
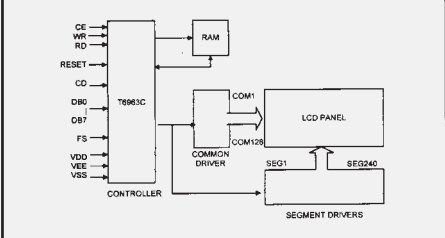

THICKNESS:

VERSION	T1	T2
EL & NO BACKLIGHT	5.5±0.3	12.0Max.
LED, CCFL BACKLIGHT	9.0±0.3	15.0Max.

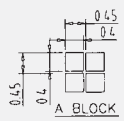

LED Dot Matrix Displays		1-9	10-49	50-99	100-299	300+
A-3570E G/W	1.2"/30.5mm orange red OA	2.105	1.934	1.838	1.741	1.644
A-5570E	2.0"/50.8mm orange red OA	2.553	2.346	2.230	2.113	1.995
A-5570G	2.0"/50.8mm green OA	2.357	2.166	2.059	1.950	1.842
A-5570SR	2.0"/50.8mm red OA	2.431	2.233	2.123	2.011	1.899
C-5570E	2.0"/50.8mm orange red OC	2.553	2.346	2.230	2.113	1.995
C-5570G	2.0"/50.8mm green OC	2.357	2.166	2.059	1.950	1.842
C-5580GE	2.3"/58.4mm orange red/green	3.804	3.594	3.414	3.294	2.995
TBA23-11EGWA	2.3"/58mm 8x8 ϕ 5 red/green OA	7.920	7.484	7.110	6.860	6.236
TBC23-12EGWA	2.3"/58mm 8x8 ϕ 5 red/green OC	7.920	7.484	7.110	6.860	6.236
LED Light Bars		1-9	10-99	100-499	500+	
KB-B100SRW	19.05 x 3.81 mm light bar, white diffused, RED	0.707	0.641	0.545	0.505	
KB-A100SRW	8.89 x 3.81 mm light bar, white diffused, RED	0.433	0.392	0.334	0.309	
KB-C100SRW	8.89 x 3.81 mm light bar, white diffused, RED	0.707	0.641	0.545	0.505	
LED Displays		1-4	5-24	25-99	100+	
C-361G	0.36"/9.1mm green OC	0.388	0.352	0.300	0.277	
SA36-11GWA	0.36"/9.1mm green OA	0.519	0.470	0.400	0.370	
SC36-11GWA	0.36"/9.1mm green OC	0.519	0.470	0.400	0.370	
SA36-11EWA	0.36"/9.1mm red OA	0.541	0.491	0.418	0.387	
SA36-11HWA	0.36"/9.1mm red OA	0.471	0.427	0.363	0.336	
C-361R	0.36"/9.1mm red OC	0.410	0.372	0.316	0.293	
SC36-11EWA	0.36"/9.1mm red OC	0.541	0.491	0.418	0.387	
SC36-11HWA	0.36"/9.1mm red OC	0.471	0.427	0.363	0.336	
SC36-11SRWA	0.36"/9.1mm red OC	0.611	0.555	0.472	0.437	
SA36-11SRWA	0.36"/9.1mm red OA	0.611	0.555	0.472	0.437	
SA39-11YWA	0.39"/9.9mm yellow OA	0.541	0.491	0.418	0.387	
SA39-11GWA	0.39"/9.9mm green OA	0.519	0.470	0.400	0.370	
SA39-11EWA	0.39"/9.9mm red OA	0.541	0.491	0.418	0.387	
SA39-11SRWA	0.39"/9.9mm red OA	0.611	0.555	0.472	0.437	
SC39-11GWA	0.39"/9.9mm green OC	0.519	0.470	0.400	0.370	
SC39-11SRWA	0.39"/9.9mm red OC	0.611	0.555	0.472	0.437	
A-402G	0.4"/10.2mm dual digit green OA	0.552	0.501	0.426	0.394	
DA04-11HWA	0.4"/10.2mm dual digit red OA	0.777	0.705	0.599	0.555	
SA05-11SRWA	0.5"/12.7mm red OA	0.611	0.555	0.472	0.437	
SA52-11EWA	0.52"/13.2mm red OA	0.566	0.514	0.437	0.404	
SA52-11HWA	0.52"/13.2mm red OA	0.496	0.450	0.383	0.354	
SA52-11SRWA	0.52"/13.2mm red OA	0.634	0.575	0.489	0.453	
SC52-11LSRWA	0.52"/13.2mm red OK	0.679	0.616	0.524	0.485	
PDA54-11HWA	0.54"/13.8mm red OK alphanumeric	1.624	1.473	1.253	1.160	
SA56-11GWA	0.56"/13.2mm green OA	0.496	0.450	0.383	0.354	
SC56-11GWA	0.56"/13.2mm green OC	0.496	0.450	0.383	0.354	
SC56-11EWA	0.56"/13.2mm red OC	0.512	0.464	0.395	0.366	
SC56-11SRWA	0.56"/13.2mm red OC	0.611	0.555	0.472	0.437	
SA56-11EWA	0.56"/13.2mm red OA	0.512	0.464	0.395	0.366	
A-562R	0.56"/14.2mm dual digit red OA	0.597	0.542	0.461	0.427	
DC56-11GWA	0.56"/14.2mm dual digit green OC	0.847	0.768	0.653	0.605	
DA56-11GWA	0.56"/14.2mm dual digit green OA	0.847	0.768	0.653	0.605	
DC56-11SRWA	0.56"/14.2mm dual digit red OC	1.060	0.961	0.818	0.757	
DA56-11SRWA	0.56"/14.2mm dual digit red OA	1.060	0.961	0.818	0.757	
DA56-11EWA	0.56"/14.2mm dual digit red OA	0.895	0.812	0.690	0.639	
DA56-11HWA	0.56"/14.2mm dual digit red OA	0.777	0.705	0.599	0.555	
DC56-11YWA	0.56"/14.2mm dual digit yellow OC	0.942	0.855	0.727	0.673	
BA56-11EWA	0.56"/14.2mm three digit red OA	1.649	1.496	1.272	1.178	
BC56-12SRWA	0.56"/14.2mm three digit red OC	1.837	1.666	1.417	1.312	
BC56-12GWA	0.56"/14.2mm three digit green OC	1.531	1.389	1.181	1.094	
SA08-11HWA	0.8"/20.32mm red OA	0.659	0.598	0.508	0.471	
SA08-11GWA	0.8"/20.32mm red OA	0.682	0.618	0.526	0.487	
DA08-11EWA	0.8"/20.3mm dual digit red OA	1.601	1.452	1.235	1.144	
DA08-11YWA	0.8"/20.3mm dual digit red OA	1.649	1.496	1.272	1.178	
C-801H	0.8"/20.3mm red OC	0.519	0.471	0.400	0.371	
C-808H	0.8"/20.3mm red OC	0.895	0.812	0.691	0.639	
SA10-11SRWA	1.0"/25.4mm red OA	1.413	1.282	1.090	1.009	
SA10-21SRWA	1.0"/25.4mm red OA	1.413	1.282	1.090	1.009	
SA10-21EWA	1.0"/25.4mm red OA	1.273	1.155	0.982	0.909	
SC10-21EWA	1.0"/25.4mm red OC	1.273	1.155	0.982	0.909	
SC10-21SRWA	1.0"/25.4mm red OC	1.413	1.282	1.090	1.009	
PSC12-11SRWA	1.2"/30mm alphanumeric , red OC	2.500	2.363	2.244	2.166	

LED Displays		1-4	5-24	25-99	100+	
SA15-11GWA	1.5"/38mm green OA	1.884	1.709	1.454	1.346	
SA15-11EWA	1.5"/38mm red OA	1.932	1.752	1.490	1.380	
SA15-11SRWA	1.5"/38mm red OA	2.072	1.880	1.599	1.480	
SA18-11GWA	1.8"/45mm green OA	2.473	2.243	1.908	1.766	
SC18-11GWA	1.8"/45mm green OC	2.473	2.243	1.908	1.766	
SA18-11EWA	1.8"/45mm red OA	2.589	2.348	1.997	1.849	
SA18-11SRWA	1.8"/45mm red OA	3.060	2.776	2.360	2.185	
SA23-12GWA	2.3"/56.9mm green OA	3.766	3.417	2.905	2.690	
SA23-11SRWA	2.3"/56.9mm red OA	4.473	4.058	3.450	3.195	
SC23-11SRWA	2.3"/56.9mm red OC	4.473	4.058	3.450	3.195	
SA23-11EWA	2.3"/56.9mm red OA	4.002	3.630	3.087	2.858	
SA23-12SRWA	2.3"/56.9mm red OA	4.473	4.058	3.450	3.195	
C-398H		0.888	0.805	0.685	0.634	
DC-10YWA	1.0"/25.4mm bargraph yellow	0.723	0.656	0.558	0.516	
DC-10GWA	1.0"/25.4mm bargraph green	0.723	0.656	0.558	0.516	
DC-7G3HWA	1.0"/25.4mm bargraph green/red	0.794	0.720	0.612	0.567	
B-1000R	1.0"/25.4mm bargraph red	0.650	0.590	0.501	0.464	
DC-10EWA	1.0"/25.4mm bargraph red	0.723	0.656	0.558	0.516	
DC-10SRWA	1.0"/25.4mm bargraph red	0.794	0.720	0.612	0.567	
LED Lamps		1-9	10-99	100-499	500-1999	2000+
L-1334SRT	3mm 20-60mcd/20mA RED TRANSPARENT	0.112	0.100	0.092	0.084	0.080
L-1464GD	2mm 3.2-12.5mcd/20mA GREEN DIFF.	0.068	0.061	0.056	0.051	0.049
L-1464HD	2mm 0.5-1.25mcd/20mA RED DIFF.	0.062	0.055	0.051	0.046	0.044
L-934GD	3mm 8-32mcd/20mA GREEN DIFF.	0.047	0.042	0.039	0.035	0.033
L-934HD	3mm 1.3-3mcd/20mA RED DIFFUSED	0.045	0.039	0.037	0.032	
L-934EC	3mm 20-80mcd/20mA RED CLEAR	0.051	0.046	0.042	0.038	0.037
L-934ID	3mm 8-50mcd/20mA RED DIFFUSED	0.051	0.046	0.042	0.038	0.037
L-934LGD	3mm 8-15mcd/2mA GREEN DIFFUSED	0.053	0.048	0.044	0.040	0.038
L-934LSRD	3mm 8-20mcd/2mA RED DIFF.	0.087	0.078	0.072	0.066	0.062
L-934MBC	3mm 12.5-40mcd/20mA BLUE CLEAR	0.740	0.660	0.608	0.555	0.528
L-934MBDL	3mm 12.5-40mcd/20mA BLUE DIFFUSED	0.740	0.660	0.608	0.555	0.528
L-934SGC	3mm 100-300mcd/20mA GREEN CLEAR	0.051	0.046	0.042	0.038	0.037
L-934SGD	3mm 100-300mcd/20mA GREEN DIFF.	0.051	0.046	0.042	0.038	0.037
L-934SRC-E	3mm 100-200mcd/20mA RED DIFF.	0.074	0.066	0.061	0.055	0.053
L-934SRD-D KING	3mm 100-200mcd/20mA RED DIFF.	0.074	0.066	0.061	0.055	0.053
L-934SRD-E KING	3mm 100-200mcd/20mA RED DIFF.	0.074	0.066	0.061	0.055	0.053
L-934YC	3mm 8-32mcd/10mA YELLOW CLEAR	0.053	0.048	0.044	0.040	0.038
L-934YD	3mm 8-32mcd/10mA YELLOW DIFF.	0.053	0.048	0.044	0.040	0.038
L-115WGYW	3mm 8-32mcd/10mA GREEN/YELLOW	0.132	0.118	0.109	0.099	0.094
L-115WEYW	3mm 8-32mcd/10mA RED/YELLOW	0.132	0.118	0.109	0.099	0.094
L-115WEGW	3mm 8-32mcd/10mA RED/YELLOW	0.132	0.118	0.109	0.099	0.094
L-403RD	2x5mm 0.4mcd/10mA RED DIFF.	0.034	0.030	0.028	0.025	0.024
L-403YD	2x5mm 0.9mcd/10mA YELLOW DIFF.	0.047	0.042	0.038	0.035	0.033
L-1531DT KING	2.3x7mm 3.2-12.5mcd/20mA RED DIFF.	0.072	0.064	0.059	0.054	0.051
L-103GD	2.3x5mm 2-8mcd/20mA GREEN DIFF.	0.052	0.047	0.043	0.039	0.037
L-113GDT	2.3x5mm 2-8mcd/20mA GREEN DIFF.	0.052	0.047	0.043	0.039	0.037
L-1131DT	2.3x5mm 2-8mcd/20mA RED DIFF.	0.057	0.051	0.047	0.043	0.041
L-493IT	1.8x5.2mm 3.2-12.5mcd/10mA RED TRANSP.	0.070	0.063	0.058	0.053	0.050
L-144EDT	1.9x3.9mm 20mcd/20mA ORANGE DIF.	0.070	0.063	0.058	0.053	0.050
L-1513SGC	5mm 100-300mcd/20mA ULTRA GREEN CLEAR	0.064	0.057	0.053	0.048	0.046
L-1513SGT	5mm 100-200mcd/20mA GREEN TRANSP.	0.064	0.057	0.053	0.048	0.046
L-1513SRC-D	5mm 1000-2000mcd/20mA ULTRA GREEN CLEAR	0.081	0.072	0.067	0.061	0.058
L-513YD	5mm 3.4mcd/10mA YELLOW DIFF.	0.027	0.024	0.022	0.020	0.019
L-53ED	5mm 12-80mcd/10mA ORANGE DIFFUSED	0.051	0.045	0.042	0.038	0.036
L-53GD KING	5mm 5-32 mcd/20mA GREEN DIFFUSED	0.048	0.043	0.040	0.036	0.035
L-531D	5mm 12-80mcd/10mA RED DIFFUSED	0.051	0.045	0.042	0.038	0.036
L-53LGD	5mm 0.8-3.2 mcd/2mA LOW CURR. GR. DIFF.	0.053	0.047	0.043	0.040	0.038
L-53LSRD	5mm 8-20mcd/2mA LOW CURR. RED DIFFUSED	0.087	0.077	0.071	0.065	0.062
L-53LYD	5mm 0.8-3.2 mcd/2mA LOW CURR. YELL.DIFF.	0.061	0.055	0.050	0.046	0.044
L-53SGC	5mm 0.8-3.2 mcd/2mA LOW CURR. GR. DIFF.	0.051	0.045	0.042	0.038	0.036
L-53SGD	5mm 0.8-3.2 mcd/2mA LOW CURR. GR. DIFF.	0.051	0.045	0.042	0.038	0.036
L-53SYD	5mm 0.8-3.2 mcd/2mA LOW CURR. YELL.DIFF.	0.195	0.174	0.160	0.146	0.139
L-53MBC	5mm 20-60mcd/20mA BLUE CLEAR	0.734	0.655	0.603	0.550	0.524
L-53MBDL	5mm 20-60mcd/20mA BLUE DIFFUSED	0.734	0.655	0.603	0.550	0.524
L-53SRC-C	5mm 500-1000mcd/20mA RED W.CLEAR	0.074	0.066	0.061	0.055	0.053
L-53SRC-F	5mm 3500-4500mcd/20mA RED W.CLEAR	0.195	0.174	0.160	0.146	0.139

LED Lamps		1-9	10-99	100-499	500-1999	2000+
L-53SRD-C	5mm 110-200mcd/20mA RED DIFFUSED	0.074	0.066	0.061	0.055	0.053
L-53SRD-E	5mm 300-500mcd/20mA RED DIFFUSED	0.074	0.066	0.061	0.055	0.053
L-53YD	5mm 0.8-3.2 mcd/2mA LOW CURR.YELL.DIFF.	0.053	0.047	0.043	0.040	0.038
L-56BHD	5mm 2-8mcd/ 9 V RED DIFF BLINKING	0.322	0.287	0.264	0.241	0.230
L-56BID	5mm 20-80 mcd/9V RED DIFF BLINKING	0.307	0.274	0.252	0.230	0.219
L-56BSRD-B	5mm 100-300mcd/10mA RED DIFFUSED	0.343	0.306	0.281	0.257	0.245
L-57EGW KING	5mm 12-40mcd/20mA bi-colour 2 terminals	0.116	0.103	0.095	0.087	0.083
L-59EGW KING	5mm 20-70mcd/20mA bi-colour 3 terminals	0.121	0.108	0.099	0.090	0.086
L-59SRSGW	5mm 40-80mcd/20mA bi-colour 3 terminals	0.143	0.128	0.118	0.108	0.102
L-803ED	8x8mm 3.1mcd/10mA RED DIFF.	0.062	0.056	0.051	0.047	0.044
L-803GD	8x8mm 2.6mcd/10mA GREEN DIFF	0.047	0.042	0.039	0.035	0.034
L-803YD	8x8mm 2.4mcd/10mA YELLOW DIFF.	0.051	0.046	0.042	0.038	0.036
L-813ED KING	10mm 20-70mcd/20mA GREEN DIFF.	0.095	0.082	0.077	0.068	
L-813GD KING	10mm 20-70mcd/20mA GREEN DIFF.	0.095	0.082	0.077	0.068	
L-813ID KING	10mm 40-150mcd/20mA RED DIFFUSED	0.108	0.093	0.087	0.077	
L-813SRC-D KING	10mm 1600-2000mcd /20mA RED CLEAR	0.286	0.247	0.231	0.204	
L-813SRC-E KING	10mm 2000-3000mcd /20mA RED CLEAR	0.286	0.247	0.231	0.204	
L-813SRC-F KING	10mm 3000-3500mcd /20mA RED CLEAR	0.286	0.247	0.231	0.204	
L-813SRD-C KING	10mm 200-350mcd /20mA RED DIFFUSED	0.119	0.103	0.096	0.085	
L-813SRD-E KING	10mm 450-550mcd /20mA RED DIFFUSED	0.119	0.103	0.096	0.085	
L-813SRD-H KING	10mm 550-660mcd /20mA RED DIFFUSED	0.280	0.242	0.226	0.200	
L-813YD KING	10mm 20-70mcd/20mA YELLOW DIFF.	0.104	0.090	0.084	0.075	
L-323HD	3mm x 4.5mm RED DIFFUSED	0.075	0.065	0.060	0.054	
L-799EGW	3mm x 4.5mm RED DIFFUSED	0.184	0.159	0.148	0.131	
DLA-6SRD	20 mm H-RED	0.997	0.861	0.804	0.712	
DLA-6SGD	20 mm S-GREEN	0.865	0.748	0.698	0.618	
DLA-6YD	20 mm YELLOW	0.865	0.748	0.698	0.618	
MLL-30231	3 mm Bright Red Diffused 3.2mcd	0.020	0.018	0.017	0.015	0.015
CLL-30221	3 mm Bright Red Diffused 1.8mcd	0.016	0.014	0.013	0.012	0.011
MLL-30331	3 mm Hi-Eff Red Diffused 12mcd	0.027	0.024	0.022	0.020	0.019
CLL-30321	3 mm Hi-Eff Red Diffused 5mcd	0.022	0.019	0.018	0.016	0.016
MLL-30431	3 mm Orange Diffused 12mcd	0.027	0.024	0.022	0.020	0.019
CLL-30421	3 mm Orange Diffused 5mcd	0.022	0.019	0.018	0.016	0.016
MLL-30531	3 mm Yellow Diffused 9mcd	0.026	0.023	0.022	0.020	0.019
CLL-30521	3 mm Yellow Diffused 3.5mcd	0.023	0.021	0.019	0.018	0.017
MLL-30631	3 mm Green Diffused 12mcd	0.024	0.021	0.019	0.018	0.017
CLL-30621	3 mm Green Diffused 3.5mcd	0.019	0.017	0.016	0.014	0.014
MLL-30332	3 mm Hi-Eff Red Transparent 30mcd	0.027	0.024	0.022	0.020	0.019
CLL-30322	3 mm Hi-Eff Red Transparent 10mcd	0.023	0.021	0.019	0.018	0.017
MLL-30532	3 mm Yellow Transparent 30mcd	0.026	0.023	0.022	0.020	0.019
CLL-30522	3 mm Yellow Transparent 10mcd	0.023	0.021	0.019	0.017	0.017
MLL-30632	3 mm Green Transparent 30mcd	0.024	0.021	0.019	0.018	0.017
CLL-30622	3 mm Green Transparent 8mcd	0.019	0.017	0.016	0.014	0.014
MLL-50231	5 mm Bright Red Diffused 4mcd	0.022	0.020	0.018	0.017	0.016
CLL-50221	5 mm Bright Red Diffused 2.5mcd	0.018	0.016	0.015	0.013	0.013
MLL-50331	5 mm Hi-Eff Red Diffused 20mcd	0.029	0.026	0.024	0.022	0.021
CLL-50321	5 mm Hi-Eff Red Diffused 5mcd	0.024	0.021	0.020	0.018	0.017
MLL-50431	5 mm Orange Diffused 20mcd	0.029	0.026	0.024	0.022	0.021
CLL-50421	5 mm Orange Diffused 5mcd	0.024	0.021	0.020	0.018	0.017
MLL-50531	5 mm Yellow Diffused 20mcd	0.028	0.025	0.023	0.021	0.020
CLL-50521	5 mm Yellow Diffused 4mcd	0.026	0.023	0.021	0.019	0.018
MLL-50631	5 mm Green Diffused 20mcd	0.026	0.023	0.021	0.019	0.018
CLL-50621	5 mm Green Diffused 4mcd	0.021	0.019	0.018	0.016	0.015
MLL-50632	5 mm Green Transparent 56mcd	0.025	0.023	0.021	0.019	0.018
CLL-50622	5 mm Green Transparent 8mcd	0.021	0.019	0.017	0.016	0.015
MLL-50332	5 mm Hi-Eff Red Transparent 55mcd	0.029	0.026	0.024	0.021	0.021
CLL-50322	5 mm Hi-Eff Red Transparent 12mcd	0.024	0.021	0.020	0.018	0.017
MLL-50432	5 mm Orange Transparent 56mcd	0.029	0.026	0.024	0.021	0.021
CLL-50422	5 mm Orange Transparent 12mcd	0.024	0.021	0.020	0.018	0.017
MLL-50532	5 mm Yellow Transparent 56mcd	0.028	0.025	0.023	0.021	0.020
CLL-50522	5 mm Yellow Transparent 12mcd	0.026	0.023	0.021	0.019	0.018
MLL-100331	10 mm Hi-Eff Red Diffused 30mcd	0.059	0.051	0.047	0.042	
MLL-100531	10 mm Yellow Diffused 30mcd	0.058	0.050	0.047	0.041	
MLL-100631	10 mm Green Diffused 30mcd	0.055	0.048	0.044	0.039	
HB5-436ARA-C	5 mm; Red; water clear ; 3000mcd	0.121	0.105	0.098	0.086	
HB5-435FO-C	5 mm; Orange; water clear ; 2400mcd	0.237	0.204	0.191	0.169	
HB5-434FY-C	5 mm; Yellow; water clear ; 5000mcd	0.237	0.204	0.191	0.169	

LED Lamps		1-9	10-99	100-499	500-1999	2000+
HB5R-233AG/P	5 mm; Green; col.clear. lens; 3100mcd	1.266	1.159	1.073		
HB5R-238AB/P	5 mm; Blue; col.clear. lens; 690mcd	1.266	1.159	1.073		
HB10b-436AR	10 mm; Red; water clear. lens; 2400mcd	0.295	0.255	0.238	0.211	
HB10b-434AY	10 mm; Yellow; water clear. lens; 2400mcd	0.367	0.317	0.296	0.262	
LEDs applicable in outdoor information displays different viewing angle in horiz.100~and vert.plane 50~, 10~shift downwards		1-9	10-99	100+	500+	
E1L4E-SB1A2-02 (L)	4 mm; Blue 290-380 mcd 470 nm 100~/50~, -10~	0.997	0.913	0.845		
E1L4E-SG1A2-02 (B)	4 mm; Green 890-1160mcd 525 nm 100~/50~, -10~	0.997	0.913	0.845		
E1L4E-SR0A2-00 (4)	4 mm; Red 260-340 mcd 610 nm 100~/50~, -10~	0.422	0.365	0.341	0.302	
SMD LEDs		1-9	10-99	100-499	500-1999	2000+
SML010DT ROHM	3x2mm 3.6-10mcd/20mA ORANGE	0.083	0.074	0.068	0.062	0.059
SML010LT ROHM	3x2mm 5.6-16mcd/20mA RED	0.095	0.085	0.078	0.071	0.068
SML010MT ROHM	3x2mm 5.6-16mcd/20mA GREEN	0.080	0.072	0.066	0.060	0.057
SML010YT ROHM	3x2mm 2.2-6.3mcd/20mA YELLOW	0.080	0.072	0.066	0.060	0.057
SML020MLT ROHM	3x2.5mm 9-16mcd/20mA RED,9-20mcd/20mA GREEN	0.175	0.156	0.144	0.131	0.125
SML210DT ROHM	2x1.25mm 3.6-10mcd/20mA ORANGE	0.067	0.060	0.055	0.050	0.048
SML210LT ROHM	2x1.25mm 3.6-10mcd/20mA RED	0.082	0.073	0.067	0.061	0.058
SML210MT ROHM	2x1.25mm 3.6-10mcd/20mA GREEN	0.067	0.060	0.055	0.050	0.048
SML210VT ROHM	2x1.25mm 1.4-4 mcd/20mA RED	0.067	0.060	0.055	0.050	0.048
SML210YT ROHM	2x1.25mm 2.2-6.3mcd/20mA YELLOW	0.067	0.060	0.055	0.050	0.048
SML211UT ROHM	2x1.5mm 0.9-2.5mcd/2mA RED	0.119	0.106	0.098	0.089	0.085
SML310VT ROHM	1.6x0.8mm 1.4 - 4mcd/2mA RED	0.076	0.068	0.063	0.057	0.055
KP-3216EC KING	3.2x1.6mm (1206), 3,2-12,5 mcd/20mA, RED	0.090	0.078	0.073	0.064	
KP-3216SGC KING	3.2x1.6mm (1206), 3,2-12,5 mcd/20mA, GREEN	0.090	0.078	0.073	0.064	
KP-3216YC KING	3.2x1.6mm (1206), 3,2-8 mcd/20mA, YELLOW	0.090	0.078	0.073	0.064	
IR Devices		1-9	10-99	100+	500+	
L-53P3BT	5mm 940nm PHOTOTRANSISTORS	0.104	0.090	0.084	0.074	
L-53F3BT	5mm 940nm 3.7-7.2mW INFRARED	0.104	0.090	0.084	0.074	
L-932P3BT	3mm 940 nm PHOTOTRANSISTORS	0.104	0.090	0.084	0.074	
L-934F3BT	3mm 940nm 2.6-3.6mcd/10mA INFRARED	0.104	0.090	0.084	0.074	
L-932P3C	3mm 940 nm PHOTOTRANSISTORS	0.104	0.090	0.084	0.074	
L-934F3C	3mm 940nm 2.6-3.6mcd/10mA INFRARED	0.104	0.090	0.084	0.074	
RPT34PB3F ROHM	3mm 800nm 32V 30mA Phototr.(compl SIR34ST3F)	0.110	0.095	0.089	0.079	
SIR34ST3F ROHM	3mm 950nm 8mW IR LED (compl. RPT34PB3F)	0.095	0.082	0.077	0.068	
SFH205	Photodiode	0.577	0.510	0.444		
RPM6938CBR-S ROHM	IR Receiver, remote control 37,9kHz 12m	0.774	0.669	0.625	0.553	
Opto-couplers with transistor output		1-4	5-24	25-99	100+	
H11AA1	20% 30V 5.33V DIL6 AC Input	0.297	0.275	0.248	0.220	
H11AA2	10% 30V 5.33V DIL6 AC Input	0.297	0.275	0.248	0.220	
H11D1	20% 300V 7.5kV 5/5uS DIL6	0.425	0.393	0.355	0.314	
H11G1	1000% 100V 7.5kV 5/5uS DIL6	0.375	0.347	0.314	0.278	
4N35	100% 70/30V 3.5kV 5/5uS DIL6	0.141	0.131	0.118	0.105	
4N35-MOT	100% 70/30V 3.5kV 5/5uS DIL6	0.155	0.144	0.130	0.115	
4N35S-MOT SMD	100% 70/30V 3.5kV 5/5uS SMD	0.169	0.156	0.141	0.125	
4N37	100% 70/30V 2.5kV 5/5uS DIL6	0.155	0.144	0.130	0.115	
6N136	25% 0.2/0.6uS 2MHz DIL8	0.449	0.390	0.362	0.345	

Opto-couplers with transistor output

		1-4	5-24	25-99	100+
6N137	5mA in 8TTL out 10Mbit/s 2.5kV DIL8	0.550	0.478	0.444	0.423
6N138	2000% DARLINGTON 7V 2.5kV DIL8	0.462	0.402	0.373	0.355
CNY17-3	100-200% 70/70V 7.5kV 6/5.5uS DIL6	0.156	0.145	0.136	0.120
CNY17-4	160-320% 70/70V 7.5kV 6/5.5uS DIL6	0.150	0.139	0.130	0.115
CNY17-4.S SMD	160-320% 70/70V 7.5kV 6/5.5uS SMD	0.170	0.158	0.148	0.131
LTV817	200-400% 35V 5kV 4/3uS DIL4	0.185	0.172	0.161	0.142
H11A817C	200-400% 35V 5.3kV 2.4/2.4uS DIL4	0.119	0.107	0.098	0.092
H11A817C.S SMD	200-400% 35V 5.3kV 2.4/2.4uS SMD	0.163	0.151	0.141	0.125

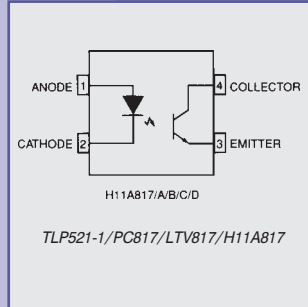
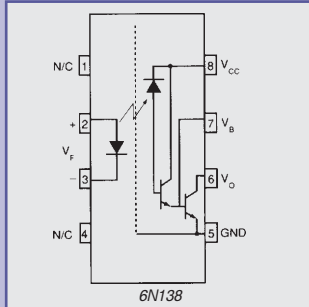
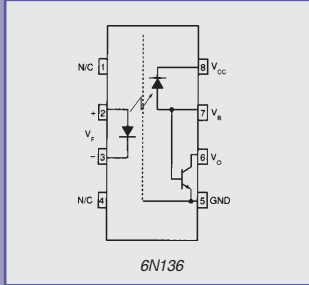
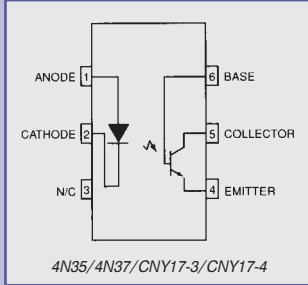
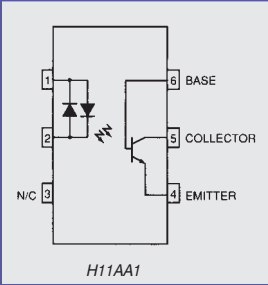

Opto-couplers with triac output

		1-4	5-24	25-99	100+
MOC3010	1 LED 15mA 250V 7.5kV without synchr.	0.275	0.247	0.230	0.204
MOC3021	1 LED 15mA 400V 7.5kV without synchr.	0.275	0.247	0.230	0.204
MOC3023	1 LED 5mA 400V 7.5kV without synchr.	0.318	0.285	0.266	0.235
MOC3041	1 LED 15mA 400V 7.5kV with synchr.	0.416	0.373	0.349	0.308
MOC3042	1 LED 10mA 400V 7.5kV with synchr.	0.430	0.386	0.360	0.319
MOC3043	1 LED 5mA 400V 5.0kV with synchr.	0.430	0.386	0.360	0.319
MOC3061	1 LED 15mA 600V 7.5kV with synchr.	0.445	0.398	0.372	0.329
MOC3063	1 LED 5mA 600V 7.5kV with synchr.	0.527	0.473	0.441	0.391
MOC3081	1 LED 15mA 800V 7.5kV with synchr.	0.757	0.679	0.634	0.561
MOC3082	1 LED 10mA 800V 7.5kV with synchr.	0.854	0.765	0.715	0.633
MOC3083	1 LED 5mA 800V 7.5kV with synchr.	0.797	0.714	0.667	0.590

Opto-couplers with air gap

		1-24	25-99	100-499	500+
H21A1	5% 30V 60mA 3.15mm -55+100 C	0.522	0.464	0.414	0.387
RPI-131 ROHM	3.5% 30V 50mA 10/10uS 1.2mm -25+85 C	0.366	0.325	0.290	0.271
RPI-352 ROHM	1.0% 30V 50mA 10/10uS 3.0mm -25+85 C	0.275	0.244	0.218	0.203
RPI-574 ROHM	2.5% 30V 50mA10/10uS 5mm -25+85 C	0.207	0.184	0.164	0.153
RPI-1133 ROHM	c mpuzep Vcc 2-7V Io 10mA 1.1mm -20+60 C	0.544	0.483	0.431	0.403
RPR-220 ROHM	3% 30V 50mA 10/10uS -25+85C reflective d=6mm	0.643	0.572	0.510	0.477

Opto-couplers with air gap

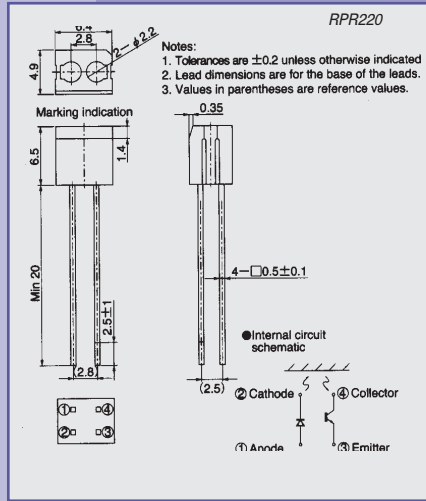
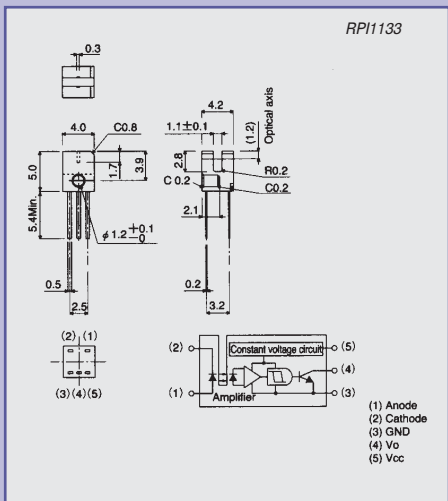
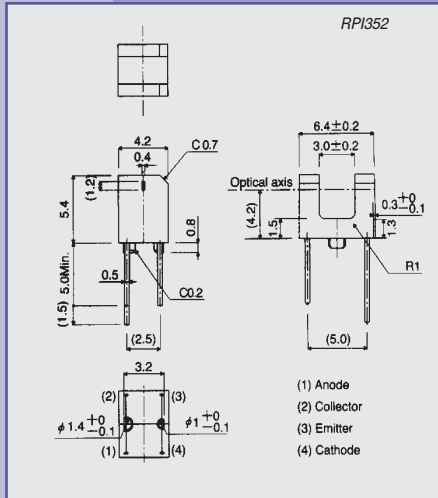
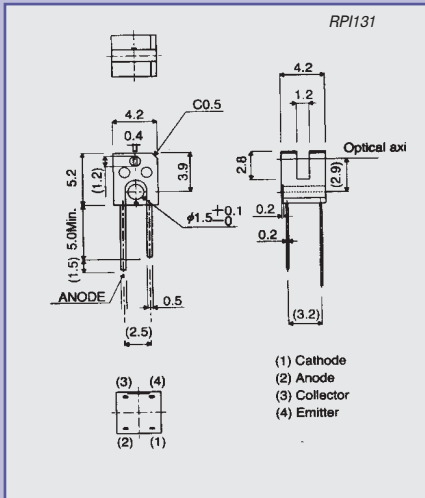

Fuses		1-4	5-24	25-99	100+
FF20X5 0.1A	Fast fuse 0.1A	0.103	0.072	0.062	0.057
FF20X5 0.2A	Fast fuse 0.2A	0.106	0.074	0.064	0.059
FF20X5 0.25A	Fast fuse 0.25A	0.133	0.093	0.080	0.074
FF20X5 0.3A	Fast fuse 0.3A	0.120	0.083	0.072	0.067
FF20X5 0.315A	Fast fuse 0.315A	0.094	0.066	0.057	0.052
FF20X5 0.5A	Fast fuse 0.5A	0.120	0.083	0.072	0.067
FF20X5 0.63A	Fast fuse 0.63A	0.099	0.069	0.060	0.055
FF20X5 1A	Fast fuse 1A	0.087	0.060	0.052	0.048
FF20X5 1.25A	Fast fuse 1.25A	0.114	0.079	0.068	0.063
FF20X5 1.5A	Fast fuse 1.5A	0.109	0.076	0.065	0.061
FF20X5 1.6A	Fast fuse 1.6A	0.114	0.079	0.068	0.063
FF20X5 2A	Fast fuse 2A	0.087	0.060	0.052	0.048
FF20X5 2.5A	Fast fuse 2.5A	0.123	0.086	0.074	0.069
FF20X5 3A	Fast fuse 3A	0.087	0.060	0.052	0.048
FF20X5 3.15A	Fast fuse 3.15A	0.123	0.086	0.074	0.069
FF20X5 4A	Fast fuse 4A	0.120	0.083	0.072	0.067
FF20X5 5A	Fast fuse 5A	0.087	0.060	0.052	0.048
FF20X5 6.3A	Fast fuse 6.3A	0.087	0.060	0.052	0.048
FF20X5 8A	Fast fuse 8A	0.121	0.084	0.072	0.067
FF20X5 10A	Fast fuse 10A	0.078	0.054	0.047	0.043
FF20X5 12A	Fast fuse 12A	0.114	0.079	0.068	0.063
FF20X5 15A	Fast fuse 15A	0.124	0.086	0.075	0.069
FF20X5 16A	Fast fuse 16A	0.114	0.079	0.068	0.063
FF20X5 20A	Fast fuse 20A	0.124	0.086	0.075	0.069
FF32X6 5A	Fast fuse 5A	0.142	0.099	0.085	0.079
FF32X6 6.3A	Fast fuse 6.3A	0.142	0.099	0.085	0.079
FF32X6 10A	Fast fuse 10A	0.139	0.096	0.083	0.077
FF32X6 15A	Fast fuse 15A	0.139	0.096	0.083	0.077
FF32X6 20A	Fast fuse 20A	0.139	0.096	0.083	0.077
ICP-N10T104 ROHM	IC protector 0.4A; Rint. 0.22ohm	0.186	0.165	0.147	0.138
ICP-N15T104 ROHM	IC protector 0.6A; Rint. 0.135ohm	0.183	0.163	0.145	0.136
ICP-N20T104 ROHM	IC protector 0.8A; Rint. 0.100ohm	0.183	0.163	0.145	0.136
ICP-N25T104 ROHM	IC protector 1.0A; Rint. 0.07ohm	0.183	0.163	0.145	0.136
ICP-N38T104 ROHM	IC protector 1.5A; Rint. 0.042ohm	0.188	0.167	0.149	0.139
ICP-N50T104 ROHM	IC protector 2.0A; Rint. 0.035ohm	0.213	0.189	0.169	0.158
TZ D104	thermal fuse 220V 16A 104 deg C	0.391	0.373	0.352	
Resettable Fuses					
		1-24	25-99	100-499	500+
MF-R010	Resettable Fuse 1h 0.1A; 60V; 2.50-4.50R	0.328	0.292	0.260	0.243
MF-R030	Resettable Fuse 1h 0.3A; 60V; 0.76-1.36R	0.330	0.293	0.261	0.244
MF-R090	Resettable Fuse 1h 0.9A; 60V; 0.14-0.31R	0.366	0.325	0.290	0.271
MF-R110	Resettable Fuse 1h 1.1A; 30V; 0.10-0.18R	0.403	0.358	0.320	0.299
MF-R185	Resettable Fuse 1h 1.85A; 30V; 0.04-0.07R	0.413	0.367	0.328	0.306
MF-R300	Resettable Fuse 1h 3A; 30V; 0.02-0.05R	0.464	0.412	0.368	0.344
Low cost sockets 2.54 mm					
		<pack	1-4packs	5-9packs	10+packs
LC6	6 pin 0.3" 7.62 mm on.=80	0.0290	0.0210	0.0186	0.0179
LC8	8 pin 0.3" 7.62 mm on.=60	0.0230	0.0160	0.0147	0.0141
LC14	14 pin 0.3" 7.62 mm on.=34	0.0280	0.0200	0.0184	0.0177
LC16	16 pin 0.3" 7.62 mm on.=30	0.0330	0.0240	0.0213	0.0204
LC18	18 pin 0.3" 7.62 mm on.=26	0.0370	0.0270	0.0239	0.0230
LC20	20 pin 0.3" 7.62 mm on.=24	0.0410	0.0300	0.0265	0.0255
LC22	22 pin 0.3" 7.62 mm on.=22	0.0470	0.0340	0.0316	0.0294
LC24-03	24 pin 0.3" 7.62 mm on.=20	0.0500	0.0360	0.0324	0.0311
LC24	24 pin 0.6" 15.24 mm on.=20	0.0500	0.0360	0.0324	0.0311
LC28-03	28 pin 0.3" 15.24 mm on.=17	0.0590	0.0420	0.0378	0.0364
LC28	28 pin 0.6" 15.24 mm on.=17	0.0570	0.0410	0.0371	0.0357
LC32	32 pin 0.3" 15.24 mm on.=15	0.0660	0.0480	0.0430	0.0413
LC40	40 pin 0.6" 15.24 mm on.=12	0.0840	0.0610	0.0543	0.0522
HIGH DENSITY Sockets 1.778 mm					
		1-9	10-99	100-499	500+
LCHD42	42 pin 0.6" 15.24 mm	0.207	0.179	0.167	0.148
LCHD64	64 pin 0.6" 19.05 mm	0.319	0.276	0.258	0.228

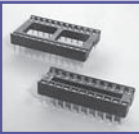
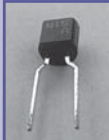

PLCC Sockets

		1-4	5-24	25-99	100+
PLCC28	PLCC socket 28 pin	0.299	0.271	0.231	0.214
PLCC32	PLCC socket 32 pin	0.304	0.276	0.235	0.217
PLCC44	PLCC socket 44 pin	0.328	0.297	0.253	0.234
PLCC52	PLCC socket 52 pin	0.354	0.321	0.273	0.253
PLCC68	PLCC socket 68 pin	0.363	0.329	0.280	0.259
PLCC84	PLCC socket 84 pin	0.413	0.375	0.319	0.295

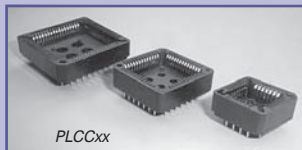
**PLCC SMD Sockets**

		1-4	5-24	25-99	100+
PLCC28 SMD	PLCC socket 28 pin SMD	0.253	0.229	0.195	0.181
PLCC32 SMD	PLCC socket 32 pin SMD	0.282	0.256	0.218	0.202
PLCC44 SMD	PLCC socket 44 pin SMD	0.416	0.377	0.321	0.297
PLCC52 SMD	PLCC socket 52 pin SMD	0.487	0.442	0.376	0.348
PLCC68 SMD	PLCC socket 68 pin SMD	0.517	0.469	0.399	0.369
PLCC84 SMD	PLCC socket 84 pin SMD	0.731	0.663	0.564	0.522

Machined Pins Sockets

		1-4	5-24	25-99	100+
M8	8 pin 0.3" 7.62 mm	0.112	0.101	0.086	0.080
M14	14 pin 0.3" 7.62 mm	0.210	0.190	0.162	0.150
M16	16 pin 0.3" 7.62 mm	0.240	0.218	0.185	0.172
M18	18 pin 0.3" 7.62 mm	0.270	0.245	0.208	0.193
M20	20 pin 0.3" 7.62 mm	0.300	0.272	0.232	0.214
M20S	20 pin SIL	0.275	0.249	0.212	0.196
M22	22 pin 0.3" 7.62 mm	0.223	0.202	0.172	0.159
M24	24 pin 0.6" 15.24 mm	0.354	0.321	0.273	0.253
M28	28 pin 0.6" 15.24 mm	0.378	0.343	0.292	0.270
M28-3	28 pin 0.3" 7.62 mm	0.378	0.343	0.292	0.270
M40	40 pin 0.6" 15.24 mm	0.617	0.560	0.476	0.441
M48	48 pin 0.6" 15.24 mm	1.040	0.943	0.802	0.743
M64	64 pin 0.9" 22.86 mm	1.386	1.257	1.069	0.990
M40S	40 pin SIL	0.555	0.503	0.428	0.396

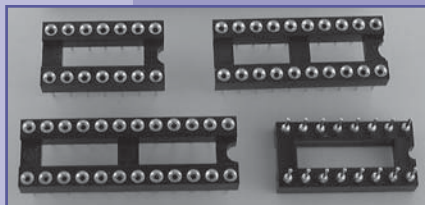
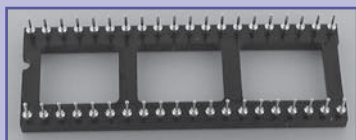
**Terminal Blocks**

		1-49	50-99	100-499	500+
TB0516 2P	16A 380V AWG12 4mm2 5mm	0.251	0.231	0.218	0.206
TB0516 3P	16A 380V AWG12 4mm2 5mm	0.383	0.352	0.333	0.314
TB1016 2P	16A 380V AWG12 4mm2 10mm	0.326	0.299	0.283	0.267
TB1016 3P	16A 380V AWG12 4mm2 10mm	0.482	0.442	0.418	0.395
TS-501 2P	10A 300V AC AWG16-22 5mm	0.136	0.118	0.110	0.105
TS-501 3P	10A 300V AC AWG16-22 5mm	0.204	0.177	0.165	0.157
TS-502 2P	10A 300V AC AWG16-22 5mm	0.142	0.124	0.115	0.110
TS-502 3P	10A 300V AC AWG16-22 5mm	0.213	0.185	0.172	0.164
TS-503 2P	10A 300V AC AWG16-22 5mm 45deg	0.161	0.140	0.130	0.124
TS-503 3P	10A 300V AC AWG16-22 5mm 45deg	0.226	0.196	0.182	0.174
TS-504 2P	10A 300V AC AWG14-18 5mm 90deg	0.158	0.137	0.127	0.121

Terminal Blocks

		1-49	50-99	100-499	500+	
TS-504	3P	10A 300V AC AWG14-18 5mm 90deg	0.235	0.205	0.190	0.181
TS-505	2P	10A 300V AC AWG14-18 5mm 90deg	0.168	0.146	0.135	0.129
TS-505	3P	10A 300V AC AWG14-18 5mm 90deg	0.250	0.218	0.202	0.193



TS-501



TS-502



TS-503

HA-522	2P	10A 300V AC AWG16-24 5mm	0.214	0.186	0.173	0.164
HA-522	3P	10A 300V AC AWG16-24 5mm	0.339	0.295	0.274	0.261
HA-522	4P	10A 300V AC AWG16-24 5mm	0.425	0.390	0.369	0.348
HA-522	8P	10A 300V AC AWG16-24 5mm	0.847	0.777	0.736	0.694
HB-953	6PH	15A 300V AC AWG14-22 9.5mm	0.956	0.878	0.831	0.784
HD-107	2P	15A 300V AC AWG14-18 STR	0.275	0.252	0.239	0.225
HD-107	2PH	15A 300V AC AWG14-18 STR	0.341	0.313	0.296	0.279
HD-107	3P	15A 300V AC AWG14-18 STR	0.407	0.374	0.354	0.334
HD-107	3PH	15A 300V AC AWG14-18 STR	0.452	0.415	0.393	0.371
HD-107	4P	15A 300V AC AWG14-18 STR	0.540	0.496	0.469	0.443
HD-107	4PH	15A 300V AC AWG14-18 STR	0.555	0.509	0.482	0.455
HD-107	5P	15A 300V AC AWG14-18 STR	0.728	0.668	0.633	0.597
HD-107	5PH	15A 300V AC AWG14-18 STR	0.733	0.673	0.637	0.601
HD-303	3PH	20A 300V AC AWG12-18 11mm	0.462	0.424	0.401	0.378
HD-323	6PH	20A 300V AC AWG12-18 11mm	1.247	1.145	1.084	1.022
HD-333	6PH	20A 300V AC AWG12-18 11mm	1.112	1.021	0.967	0.912
HD-331	2P	20A 300V AC AWG12-18 11mm	0.545	0.501	0.474	0.447
HD-331	3P	20A 300V AC AWG12-18 11mm	0.545	0.501	0.474	0.447



HD-107



HD-303



HD-333

HD-511	2P	10A 300V AC AWG14-18 5mm	0.211	0.184	0.171	0.163
HD-511	3P	10A 300V AC AWG14-18 5mm	0.317	0.276	0.256	0.244
HD-512	2P	10A 300V AC AWG14-18 5mm	0.185	0.161	0.149	0.142
HD-512	3P	10A 300V AC AWG14-18 5mm	0.315	0.274	0.254	0.242
HD-513	2P	10A 300V AC AWG14-18 5mm	0.260	0.226	0.210	0.200
HD-513	3P	10A 300V AC AWG14-18 5mm	0.387	0.336	0.312	0.298
HD-515R	2P	10A 300V AC AWG12-16 5mm 90deg	0.411	0.367	0.343	
HD-515R	3P	10A 300V AC AWG12-16 5mm 90deg	0.786	0.701	0.655	
HD-515R	4P	10A 300V AC AWG12-16 5mm 90deg	0.821	0.732	0.684	
HD-515R	5P	10A 300V AC AWG12-16 5mm 90deg	1.033	0.921	0.861	
HD-515R	6P	10A 300V AC AWG12-16 5mm 90deg	1.233	1.099	1.027	
HD-515V	2P	10A 300V AC AWG12-16 5mm	0.396	0.353	0.330	



HD-831

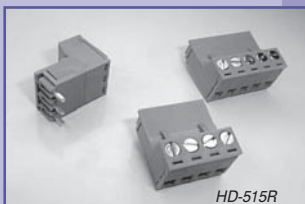

HD-515R



HD-515V

Terminal Blocks

		1-49	50-99	100-499	500+	
HD-515V	3P	10A 300V AC AWG12-16 5mm	0.750	0.669	0.625	
HD-515V	4P	10A 300V AC AWG12-16 5mm	0.796	0.709	0.663	
HD-515V	6P	10A 300V AC AWG12-16 5mm	1.235	1.101	1.029	
HD-831	2P	15A 300V AC AWG14-18 8.25mm	0.256	0.235	0.222	0.210
HD-831	3P	15A 300V AC AWG14-18 8.25mm	0.384	0.353	0.334	0.315
HD-831	4P	15A 300V AC AWG14-18 8.25mm	0.518	0.475	0.450	0.425
HD-831	5P	15A 300V AC AWG14-18 8.25mm	0.649	0.596	0.564	0.532
HD-831	20P	15A 300V AC AWG14-18 8.25mm	2.445	2.362	2.072	
HD-832	7PH	15A 300V AC AWG14-18 8.25mm	1.053	1.018	0.893	
K13			0.130	0.115	0.103	0.096
K14			0.123	0.109	0.098	0.091
K15			0.147	0.131	0.117	0.109
230WP-12			1.110	0.989	0.925	
500WP-12			1.204	1.073	1.003	

Relays

		1-9	10-99	100-499	500+
EDR201A0503	REED RELAY 5V 0.5/1A 10VA 100Vdc 1/0.5ms	1.021	0.937	0.837	
EDR201A1203	REED RELAY 12V 0.5/1A 10VA 100Vdc 1/0.5ms	1.060	0.973	0.869	
FBR46ND012-PCSA	12V 1A/30VDC 0.5A/120VAC FUJITSU	1.771	1.626	1.452	
MD-5	Reed 5V/10mA 0.5A/20V 0.1A/100V 1Amax	0.807	0.717	0.639	0.598
MD-12	Reed 12V/12mA 0.5A/20V 0.1A/100V 1Amax	0.807	0.717	0.639	0.598
TDS-05-02-L	5V /40mA 2A/28VDC 0.5A/120VAC 3A max	0.869	0.773	0.689	0.644
TDS-12-02-L	12V /17mA 2A/28VDC 0.5A/120VAC 3A max	0.869	0.773	0.689	0.644
TDS-24-02-L	24V /8mA 2A/28VDC 0.5A/120VAC 3A max	0.869	0.773	0.689	0.644
RAS-05-15	24V /15mA 15A/24VDC(120VAC) 10A/250VAC	0.520	0.462	0.412	0.385
RAS-24-15	24V /15mA 15A/24VDC(120VAC) 10A/250VAC	0.520	0.462	0.412	0.385
RAS-12-15	12V /30mA 15A/24VDC(120VAC) 10A/250VAC	0.520	0.462	0.412	0.385
SAR1-2C-12-15	12V /77mA 15A/12VDC(120VAC)	0.866	0.770	0.686	0.642
SVF-12-30-A	12V /100mA 30A/250VAC(30VDC) 35A max	2.555	2.271	2.025	1.893
SCB-1-M-12-40	12V /117mA 40A/12VDC 25A/24VDC 50A max	1.272	1.131	1.008	0.943
RX2-12-30	12V /133mA 30A/24VDC 30A/14VDC 35A max	0.917	0.815	0.727	0.680
THU-12-03	12V /17mA 3A/60VDC, 3A/24VDC 3A max	0.647	0.575	0.513	0.479
TNC-1C-05-12	5V /66.7mA 12A/110VDC 12A/30VDC 12A max	1.232	1.096	0.977	0.913
TNC-2C-05-08	5V /66.7mA 8A/110VDC 8A/30VDC 8A max	1.435	1.276	1.137	1.063
TNC-1C-12-12	12V /33.3mA 12A/110VDC 12A/30VDC 12A max	1.232	1.096	0.977	0.913
TNC-2C-12-08	12V /33.3mA 8A/110VDC 8A/30VDC 8A max	1.435	1.276	1.137	1.063
TNC-1C-12-16	12V /33.3mA 16A/110VDC 16A/30VDC 16A max	1.435	1.276	1.137	1.063
TNC-1C-24-12	24V /16.7mA 12A/110VDC 12A/30VDC 12A max	1.255	1.116	0.995	0.930
TNC-2C-24-08	24V /16.7mA 8A/110VDC 8A/30VDC 8A max	1.480	1.316	1.173	1.096
TNC-1C-24-16	24V /16.7mA 16A/110VDC 16A/30VDC 16A max	1.255	1.116	0.995	0.930



RAS-xx-xx

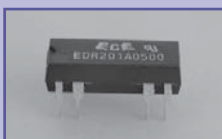

EDR201Axxxx



TNC-xC-xx-xx



SCB-1-M-12-40

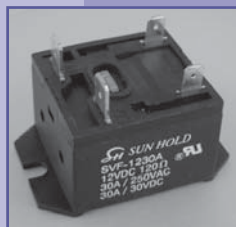

SVF-12-30-A

Connectors

DB9PM	<i>D-SUB 9 male solder</i>
DB9PF	<i>D-SUB 9 female solder</i>
DB15PM	<i>D-SUB 15 male solder</i>
DB15PF	<i>D-SUB 15 female solder</i>
DB25PM	<i>D-SUB 25 male solder</i>
DB25PF	<i>D-SUB 25 female solder</i>
DB37PM	<i>D-SUB 37 male solder</i>
DB37PF	<i>D-SUB 37 female solder</i>
DB50PM	<i>D-SUB 50 male solder</i>
DB50PF	<i>D-SUB 50 female solder</i>



DB9Px



DB25Px



DB15PF

DB15PM

1-9	10-99	100-499	500+
0.098	0.089	0.076	0.070
0.116	0.105	0.090	0.083
0.136	0.123	0.105	0.097
0.155	0.141	0.120	0.111
0.138	0.125	0.106	0.098
0.189	0.172	0.146	0.135
0.401	0.355	0.339	0.308
0.381	0.337	0.322	0.293
0.855	0.756	0.723	0.658
0.888	0.785	0.751	0.683

DB9BM	<i>D-SUB 9 straight PCB male</i>
DB9BF	<i>D-SUB 9 straight PCB female</i>
DB15BM	<i>D-SUB 15 straight PCB male</i>
DB15BF	<i>D-SUB 15 straight PCB female</i>
DB25BM	<i>D-SUB 25 straight PCB male</i>
DB25BF	<i>D-SUB 25 straight PCB female</i>
DB37BM	<i>D-SUB 37 straight PCB male</i>
DB37BF	<i>D-SUB 37 straight PCB female</i>



DB9Bx

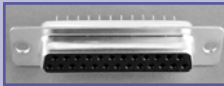

DB25BF

1-9	10-99	100-499	500+
0.157	0.143	0.121	0.112
0.158	0.143	0.122	0.113
0.226	0.205	0.174	0.161
0.229	0.208	0.177	0.163
0.315	0.286	0.243	0.225
0.265	0.240	0.204	0.189
0.674	0.596	0.571	0.519
0.689	0.610	0.583	0.530



DB15Bx

DB9BMR	<i>D-SUB 9 right angle PCB male</i>
DB9BFR	<i>D-SUB 9 right angle PCB female</i>
DB15BMR	<i>D-SUB 15 right angle PCB male</i>
DB15BFR	<i>D-SUB 15 right angle PCB female</i>
DB25BMR	<i>D-SUB 25 right angle PCB male</i>
DB25BFR	<i>D-SUB 25 right angle PCB female</i>
DB37BMR	<i>D-SUB 37 right angle PCB male</i>
DB37BFR	<i>D-SUB 37 right angle PCB female</i>
DB50BMR	<i>D-SUB 50 right angle PCB male</i>
DB50BFR	<i>D-SUB 50 right angle PCB female</i>



DB9BFR

DB9BMR



DB25BxR

0.221	0.201	0.171	0.158
0.229	0.207	0.176	0.163
0.319	0.290	0.246	0.228
0.296	0.268	0.228	0.211
0.382	0.347	0.295	0.273
0.370	0.336	0.286	0.264
0.674	0.596	0.570	0.519
0.638	0.564	0.540	0.491
0.796	0.704	0.673	0.612
0.800	0.707	0.677	0.615



DB15BxR

DB9SM	<i>D-SUB 9 flat cable male</i>
DB9SF	<i>D-SUB 9 flat cable female</i>
DB15SM	<i>D-SUB 15 flat cable male</i>
DB15SF	<i>D-SUB 15 flat cable female</i>
DB25SM	<i>D-SUB 25 flat cable male</i>
DB25SF	<i>D-SUB 25 flat cable female</i>
DB37SM	<i>D-SUB 37 flat cable male</i>
DB37SF	<i>D-SUB 37 flat cable female</i>

1-9	10-99	100-499	500+
0.535	0.473	0.453	0.411
0.536	0.474	0.453	0.412
0.728	0.644	0.616	0.560
0.732	0.647	0.619	0.563
0.711	0.629	0.601	0.547
0.721	0.637	0.610	0.554
1.796	1.588	1.519	1.381
1.813	1.604	1.534	1.394

Connectors

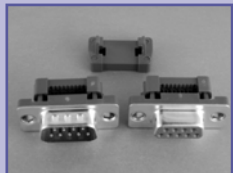

DB9Sx

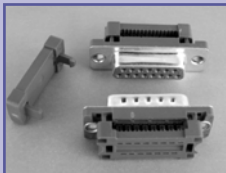

DB15Sx



DB25Sx



DB9SNx



DB15SNF



DB25SNx

DB9SNM
DB9SNF
DB15SNM
DB15SNF
DB25SNM
DB25SNF

D-SUB 9 SNAP male
D-SUB 9 SNAP female
D-SUB 15 SNAP male
D-SUB 15 SNAP female
D-SUB 25 SNAP male
D-SUB 25 SNAP female

1-9	10-99	100-499	500+
0.309	0.273	0.261	0.238
0.264	0.234	0.223	0.203
0.412	0.364	0.348	0.317
0.424	0.375	0.359	0.326
0.392	0.346	0.331	0.301
0.401	0.355	0.339	0.308

DHS15P
DHS15S
DHR15SR

D-SUB 15 High Density male solder
D-SUB 15 High Density female solder
D-SUB 15 High Density right angle PCB female

0.227	0.194	0.175
0.230	0.197	0.177
0.346	0.296	0.266



DHR15SR

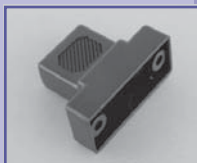

HDB9PF



HDB9P

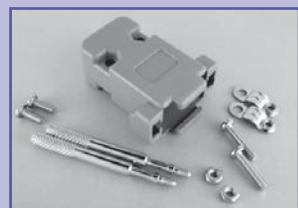

HDB9PT



HDB15P

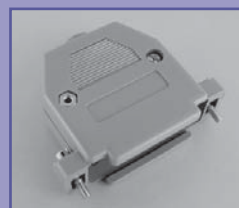

HDB25P

HDB9P
HDB9PS
HDB9PF
HDB9PT
HDB9MT
HDB15P
HDB15PT
HDB25P
HDB25PS

D-SUB 9 hood
D-SUB 9 hood SNAP
D-SUB 9 hood flat cable
D-SUB 9 hood thumb screw
D-SUB 9 hood chromate plated, thumb screw
D-SUB 15 hood
D-SUB 9 hood thumb screw
D-SUB 25 hood
D-SUB 25 hood SNAP

1-9	10-99	100-499	500+
0.151	0.129	0.118	0.112
0.171	0.145	0.133	0.126
0.175	0.149	0.136	0.130
0.248	0.211	0.193	0.184
0.394	0.336	0.307	0.292
0.207	0.176	0.161	0.153
0.214	0.183	0.167	0.159
0.169	0.144	0.131	0.125
0.199	0.170	0.155	0.148

Connectors

		1-9	10-99	100-499	500+
HDB25PT	D-SUB 25 hood thumb screw	0.444	0.378	0.345	0.329
HDB25PF	D-SUB 25 hood flat cable	0.206	0.176	0.161	0.153
HDB25MT	D-SUB 25 hood chromate plated, thumb screw	0.457	0.389	0.356	0.339
HDB37P	D-SUB 37 hood	0.302	0.258	0.235	0.224
HDB37PT	D-SUB 37 hood thumb screw	0.449	0.382	0.349	0.333
GC9/9	Cover D-SUB9/D-SUB9	0.251	0.223	0.199	0.186
GC9/25	Cover D-SUB9/D-SUB25	0.286	0.255	0.227	0.212
GC15/15	Cover D-SUB15/D-SUB15	0.326	0.290	0.258	0.241
GC25/36	Cover D-SUB25/CENTR36	0.388	0.345	0.307	0.287
GC25/25	Cover D-SUB25/D-SUB25	0.276	0.246	0.219	0.205
GC36/36	Cover CENTR36/CENTR36	0.386	0.343	0.306	0.286
GC25/25T	Cover D-SUB25/D-SUB25 with opening	0.368	0.327	0.292	0.273

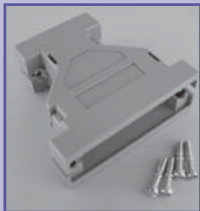

GC9/25



CENxxSF

		1-9	10-99	100+
CEN24BFR	Centronic 24p female angled for PCB	0.621	0.554	0.518
CEN36PM	Centronic 24p male solder	0.632	0.564	0.527
CEN36SF	Centronic 36p female flat cable	0.819	0.731	0.683
CEN36BFR	Centronic 36p female angled for PCB	1.060	0.945	0.883
CEN50PM	Centronic 50p male solder	1.496	1.334	1.247
CEN50SF	Centronic 50p female flat cable	2.352	2.097	1.960
CEN50BFR	Centronic 50p female angled for PCB	2.418	2.156	2.015

		1-9	10-99	100-499	500+
IDC10DH	IDC (flat cable) socket connector 10c	0.080	0.071	0.063	0.059
IDC14DH	IDC socket connector 14c	0.111	0.098	0.088	0.082
IDC16DH	IDC socket connector 16c	0.113	0.100	0.089	0.084
IDC20DH	IDC socket connector 20c	0.118	0.105	0.093	0.087
IDC26DH	IDC socket connector 26c	0.118	0.105	0.094	0.088
IDC34DH	IDC socket connector 34c	0.129	0.115	0.103	0.096
IDC40DH	IDC socket connector 40c	0.138	0.123	0.110	0.102
IDC50DH	IDC socket connector 50c	0.158	0.140	0.125	0.117
IDC64DH	IDC socket connector 64c	0.219	0.194	0.173	0.162



IDCxxDH

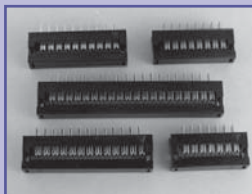

PCTxx



ECxx

		1-9	10-99	100-499	500+
PCT14	Transition Plug Connector(fl.cable)2x7	0.179	0.152	0.146	0.132
PCT16	Transition Plug Connector(fl.cable) 2x8	0.179	0.153	0.146	0.133
PCT20	Transition Plug Connector(fl.cable)2x10	0.255	0.217	0.208	0.189
PCT26	Transition Plug Connector(fl.cable)2x13	0.269	0.229	0.219	0.199
PCT34	Transition Plug Connector(fl.cable)2x17	0.289	0.246	0.235	0.214
PCT40	Transition Plug Connector(fl.cable)2x20	0.377	0.321	0.307	0.279

Connectors

		1-9	10-99	100-499	500+
EC20	Edge Connector for flat cable 20c	0.182	0.155	0.149	0.135
EC34	Edge Connector for flat cable 34c	0.184	0.157	0.150	0.136
EC40	Edge Connector for flat cable 40c	0.530	0.452	0.432	0.393

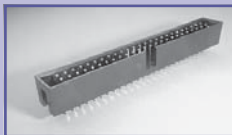

BHxxS



BHxxS

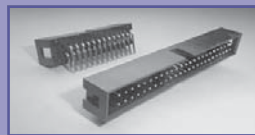

BHxxR

BH6S	Box Header Connector 2x3	0.059	0.051	0.046	0.044
BH20S	Box Header Connector 2x10	0.073	0.062	0.056	0.054
BH26S	Box Header Connector 2x13	0.087	0.074	0.068	0.064
BH34S	Box Header Connector 2x17	0.093	0.079	0.073	0.069
BH40S	Box Header Connector 2x20	0.100	0.085	0.078	0.074
BH50S	Box Header Connector 2x25	0.132	0.113	0.103	0.098

BH20R	Box Header Connector right angle 2x10	0.150	0.128	0.117	0.111
BH26R	Box Header Connector right angle 2x13	0.164	0.140	0.127	0.121
BH34R	Box Header Connector right angle 2x17	0.211	0.180	0.164	0.156
BH40R	Box Header Connector right angle 2x20	0.241	0.205	0.187	0.179
BH50R	Box Header Connector right angle 2x25	0.301	0.256	0.234	0.223

PN1X8	Board to B. Socket Straight 8.5mm 1x8	0.075	0.067	0.059	0.056
PN1X10	Board to B. Socket Straight 8.5mm 1x10	0.078	0.069	0.062	0.058
PN1X20	Board to B. Socket Straight 8.5mm 1x20	0.146	0.130	0.116	0.108
PN1X24	Board to B. Socket Straight 8.5mm 1x24	0.177	0.157	0.140	0.131
PN1X40	Board to B. Socket Straight 8.5mm 1x40	0.293	0.260	0.232	0.217

PN2X8	Board to B. Socket Straight 8.5mm 2x8	0.219	0.195	0.174	0.162
PN2X10	Board to B. Socket Straight 8.5mm 2x10	0.144	0.128	0.114	0.107
PN2X15	Board to B. Socket Straight 8.5mm 2x15	0.345	0.307	0.273	0.256
PN2X16	Board to B. Socket Straight 8.5mm 2x16	0.377	0.335	0.299	0.279
PN2X20	Board to B. Socket Straight 8.5mm 2x20	0.425	0.378	0.337	0.315
PN2X40	Board to B. Socket Straight 8.5mm 2x40	0.555	0.493	0.440	0.411

PR2X15	Board to B. Socket R.angle 8.5mm 1x15	0.365	0.325	0.289	0.271
PR2X20	Board to B. Socket R.angle 8.5mm 1x15	0.573	0.509	0.454	0.424

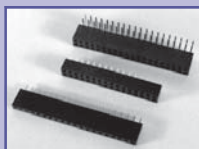

PNxx/PRxx

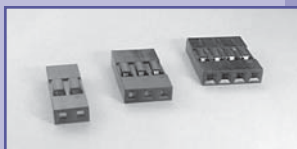

PNB1Xxx



PNB2Xxx

PNB1X2	2.54 mm Wire to Board Connector 1x2	0.033	0.029	0.026	0.024
PNB1X3	2.54 mm Wire to Board Connector 1x3	0.034	0.030	0.027	0.025
PNB1X4	2.54 mm Wire to Board Connector 1x4	0.039	0.035	0.031	0.029
PNB1X6	2.54 mm Wire to Board Connector 1x6	0.054	0.048	0.042	0.040
PNB1X10	2.54 mm Wire to Board Connector 1x10	0.094	0.084	0.075	0.070
PNB2X2	2.54 mm Wire to Board Connector 2x2	0.072	0.064	0.057	0.053
PNB2X3	2.54 mm Wire to Board Connector 2x3	0.107	0.095	0.085	0.080
PNB2X5	2.54 mm Wire to Board Connector 2x5	0.113	0.101	0.090	0.084
PNB2X6	2.54 mm Wire to Board Connector 2x6	0.190	0.169	0.151	0.141
PNB2X10	2.54 mm Wire to Board Connector 2x10	0.181	0.161	0.144	0.134
PPLUG	Polarizing Plug for PNB Connectors	0.021	0.018	0.016	0.015

DILF14	DIP Plug Connector 14p	0.378	0.336	0.300	0.280
DILF16	DIP Plug Connector 16p	0.381	0.339	0.302	0.283
DILF18	DIP Plug Connector 18p	0.435	0.387	0.345	0.323
DILF20	DIP Plug Connector 20p	0.486	0.432	0.385	0.360

Connectors		1-9	10-99	100-499	500+
DILF24	<i>DIP Plug Connector 24p</i>	0.601	0.534	0.476	0.445
DILF28	<i>DIP Plug Connector 28p</i>	0.900	0.800	0.713	0.666
DILF32	<i>DIP Plug Connector 32p</i>	0.926	0.823	0.734	0.686
DILF40	<i>DIP Plug Connector 40p</i>	0.933	0.829	0.740	0.691
BNCRG58	<i>BNC Connector 50 Ohm , RG58</i>	0.362	0.321	0.287	0.268
BNCRG59	<i>BNC Connector 75 Ohm , RG59</i>	0.299	0.266	0.237	0.222
BNCRG62	<i>BNC Connector 83 Ohm , RG62</i>	0.643	0.571	0.509	0.476
BNCTERM50	<i>BNC Terminator 50 Ohm</i>	0.445	0.395	0.352	0.329
BNCTERM75	<i>BNC Terminator 75 Ohm</i>	0.744	0.661	0.590	0.551
BNCT	<i>BNC T Connector</i>	0.612	0.544	0.485	0.453
HN1X40	<i>Single row pin header 1x40 , 2.5mm</i>	0.059	0.053	0.047	0.044
HN2X18	<i>Double row pin header 2x18, 2.5mm</i>	0.043	0.038	0.034	0.032
HN2X40	<i>Double row pin header 2x40, 2.5mm</i>	0.120	0.106	0.095	0.089
HR1X40	<i>Single row pin header 1x40 , 2.5mm, 90 °</i>	0.116	0.103	0.092	0.086
HR2X40	<i>Double row pin header 2x40, 2.5mm, 90 °</i>	0.311	0.277	0.247	0.231



HN2Xxx

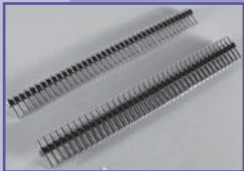

HR1X40 HR2X40

		1-9	10-99	100-499	500+
HN1X20-2.0	<i>Single row pin header 1x20 , 2mm,</i>	0.139	0.124	0.111	0.103
HN2X20-2.0	<i>Double row pin header 2x20, 2mm</i>	0.279	0.248	0.221	0.206
KB5W	<i>DIN5 connector PCB</i>	0.377	0.335	0.299	0.279
SCART21	<i>Connector SCART</i>	0.748	0.638	0.575	
AC PLUG 6A 250V	<i>AC Plug 6A 250V</i>	0.750	0.640	0.577	
AP340	<i>Stereo Plug 3.5mm</i>	0.174	0.149	0.134	
BP201		0.140	0.120	0.108	
DIN5P	<i>DIN5 plug</i>	0.265	0.226	0.204	
GC2141	<i>DIN5P F/MINI DIN6P M</i>	1.334	1.139	1.026	
YAS2020	<i>Power Jack 10A 250V</i>	0.448	0.382	0.344	
TV1101 M	<i>TV Plug</i>	0.164	0.145	0.130	0.121
TV1102 F	<i>TV Jack</i>	0.160	0.142	0.127	0.118
YDJ-1132	<i>DC Power Jack 2.5mm lead wire terminals</i>	0.577	0.513	0.458	0.428
YDJ1136	<i>DC Power Jack 2.5mm P.C.B. terminals</i>	0.186	0.165	0.147	0.138
YPJ-8168X	<i>Phone Jack 3.5mm</i>	0.260	0.231	0.206	0.192
BH322A	<i>Battery holder for 2 "AA"</i>	0.203	0.180	0.156	
BH341A	<i>Battery holder for 4 "AA"</i>	0.403	0.356	0.310	
BS-TC	<i>9V battery snap (crimping type)</i>	0.093	0.080	0.077	0.067
PC1215	<i>Fuse holder for fuse 5x20mm</i>	0.349	0.309	0.269	
C702 10M 008 206 4	<i>connector ISO smart card low profile</i>	1.259	1.142	0.971	0.899



SCART21



Battery holder

DIN41 612 C EURO Connectors HARTING		1-9	10-99	100+
DINC96MR	<i>conn. DIN 41612C 96 male angled</i>	1.064	0.911	0.851
DINC64MR	<i>conn. DIN 41612C 64 A-C male angled</i>	0.819	0.701	0.655
DINC32MR	<i>conn. DIN 41612C 32 A-C male angled</i>	0.911	0.780	0.729
DINC64FS4.5	<i>conn. DIN 41612C 64 female solder 4.5mm</i>	0.778	0.666	0.622
DINC96FW13	<i>conn. DIN 41612C 96 female wrap13mm</i>	2.343	2.006	1.875
DINC64FW13	<i>conn. DIN 41612C 64 female wrap13mm</i>	1.801	1.542	1.441

Connectors

1-9 10-99 100-499 500+



TPLxx



TSxPxC

TPL4P	Telephone Modular Plug 4p	0.034	0.025	0.022	0.021
TPL6P	Telephone Modular Plug 6p	0.048	0.036	0.031	0.029
TPL6P4C	Telephone Modular Plug 6p 4c	0.041	0.030	0.026	0.025
TPL6PMP	Telephone Modular Plug 6p MP	0.080	0.056	0.052	0.048
TPL8P(RJ45)	Modular Plug 8p RJ45	0.090	0.072	0.066	0.061
TS6P4C-PCB	Telephone PCB mount Jack 6p4c	0.202	0.179	0.164	0.150
TS6P6C-PCB	Telephone PCB mount Jack 6p6c	0.211	0.188	0.172	0.156
TS8P8C-PCB	Jack PCB RJ45	0.272	0.241	0.221	0.201
MJ6	Jumper 2.54/6mm	0.019	0.008	0.005	0.004
PWL4S	Connector PCB 3.96mm 4P 7A/250V	0.034	0.031	0.027	0.026
PWL6S	Connector PCB 3.96mm 6P 7A/250V	0.051	0.045	0.040	0.038
PWL6R	Connector r.angle PCB 3.96mm 6P 7A/250V	0.066	0.058	0.052	0.049
PHU3	Crimp Terminal Conn. 3.96mm 3P 7A/250V	0.042	0.037	0.033	0.031
PHU4	Crimp Terminal Conn. 3.96mm 4P 7A/250V	0.052	0.046	0.041	0.038
PHU6	Crimp Terminal Conn. 3.96mm 6P 7A/250V	0.072	0.064	0.057	0.053
WF2R	Connector 90° PCB 2.54mm 2P 3A/250V	0.013	0.011	0.010	0.009
WF2S	Connector PCB 2.54mm 2P 3A/250V	0.011	0.009	0.008	0.008
WF3R	Connector 90° PCB 2.54mm 3P 3A/250V	0.019	0.017	0.015	0.014
WF3S	Connector PCB 2.54mm 3P 3A/250V	0.016	0.014	0.013	0.012
WF4R	Connector 90° PCB 2.54mm 4P 3A/250V	0.025	0.022	0.020	0.018
WF4S	Connector PCB 2.54mm 4P 3A/250V	0.021	0.019	0.017	0.016
WF5R	Connector 90° PCB 2.54mm 5P 3A/250V	0.031	0.028	0.025	0.023
WF5S	Connector PCB 2.54mm 5P 3A/250V	0.026	0.024	0.021	0.020
WF6R	Connector 90° PCB 2.54mm 6P 3A/250V	0.038	0.034	0.030	0.028
WF6S	Connector 90° PCB 2.54mm 6P 3A/250V	0.033	0.029	0.026	0.024
HU2	Crimp Terminal Conn. 2.54mm 2P 3A/250V	0.015	0.013	0.012	0.011
HU3	Crimp Terminal Conn. 2.54mm 3P 3A/250V	0.022	0.020	0.018	0.016
HU4	Crimp Terminal Conn. 2.54mm 4P 3A/250V	0.029	0.026	0.023	0.022
HU5	Crimp Terminal Conn. 2.54mm 5P 3A/250V	0.038	0.034	0.030	0.028
HU6	Crimp Terminal Conn. 2.54mm 6P 3A/250V	0.044	0.039	0.035	0.033



HUx



WFxS/R

		1-9	10-99	100-499	500+
AC2	Connector PCB 7.5(5.0)mm 2P 3A/250V	0.032	0.028	0.025	0.023
AC3	Connector PCB 7.5(5.0)mm 3P 3A/250V	0.045	0.040	0.036	0.034
AC4	Connector PCB 7.5(5.0)mm 4P 3A/250V	0.058	0.052	0.046	0.043
AC5	Connector PCB 7.5(5.0)mm 5P 3A/250V	0.069	0.062	0.055	0.051
AC6	Connector PCB 7.5(5.0)mm 6P 3A/250V	0.115	0.102	0.091	0.085
ACH2	Crimp Term.Conn. 7.5(5.0)mm 2P 3A/250V	0.034	0.030	0.027	0.025
ACH3	Crimp Term.Conn. 7.5(5.0)mm 3P 3A/250V	0.053	0.047	0.042	0.039
ACH4	Crimp Term.Conn. 7.5(5.0)mm 4P 3A/250V	0.064	0.057	0.051	0.047
ACH5	Crimp Term.Conn. 7.5(5.0)mm 5P 3A/250V	0.082	0.073	0.065	0.061
ACH6	Crimp Term.Conn. 7.5(5.0)mm 6P 3A/250V	0.104	0.093	0.083	0.077

Connectors

		1-9	10-99	100-499	500+
FF10Z9R	Flat Flexible Cable Conn. 9p 1mm 90°	0.204	0.186	0.163	0.151
FF10Z9S	Flat Flexible Cable Conn. 9p 1mm	0.204	0.186	0.163	0.151
FF10L14S	Flat Flexible Cable Conn. 14p 1mm	0.211	0.191	0.163	0.151
FF10Z14RD	Flat Flexible Cable Conn. 14p 1mm 90° downside	0.251	0.227	0.193	0.179
FF12Z20R	Flat Flexible Cable Conn. 20p 1.25mm	0.526	0.479	0.421	0.390
FF12Z20S	Flat Flexible Cable Conn. 20p 1.25mm	0.526	0.479	0.421	0.390
FF25L6R	Flat Flexible Cable Conn. 6p 2.54mm 90°	0.077	0.070	0.060	0.055
FF25L6S	Flat Flexible Cable Conn. 6p 2.54mm	0.077	0.070	0.060	0.055
FF25L8R	Flat Flexible Cable Conn. 8p 2.54mm 90°	0.087	0.079	0.067	0.062
FF25L8S	Flat Flexible Cable Conn. 8p 2.54mm	0.101	0.092	0.078	0.072
FF25L9R	Flat Flexible Cable Conn. 9p 2.54mm 90°	0.096	0.087	0.074	0.069
FF25L9S	Flat Flexible Cable Conn. 9p 2.54mm	0.096	0.087	0.074	0.069



FF10ZxxR



FF10ZxS



FF10LxxR



FF12ZxxR



FF12ZxS



FF25LxR



FF25LxS

HS02	Crimp Term.Conn.2.50mm 2P 3A/250V 90°	0.014	0.012	0.011	0.010
HS03	Crimp Term.Conn.2.50mm 3P 3A/250V 90°	0.021	0.019	0.016	0.015
HS04	Crimp Term.Conn.2.50mm 4P 3A/250V 90°	0.027	0.025	0.021	0.020
HS05	Crimp Term.Conn.2.50mm 5P 3A/250V 90°	0.037	0.033	0.028	0.026
HS06	Crimp Term.Conn.2.50mm 6P 3A/250V 90°	0.043	0.039	0.033	0.031



HSxx

WS02R	Connector PCB 2.50mm 2P 3A/250V	0.012	0.011	0.009	0.008
WS03R	Connector PCB 2.50mm 3P 3A/250V	0.026	0.024	0.020	0.019
WS04R	Connector PCB 2.50mm 4P 3A/250V	0.023	0.021	0.018	0.017
WS05R	Connector PCB 2.50mm 5P 3A/250V	0.035	0.032	0.027	0.025
WS06R	Connector PCB 2.50mm 6P 3A/250V	0.043	0.039	0.033	0.031



WSxxR

PWA10R	DIP Solder Headers ,90°, 4.20mm 2X5P 7A	0.427	0.388	0.330	0.305
PWA14R	DIP Solder Headers ,90°, 4.20mm 2X4P 6A	0.562	0.510	0.433	0.401
PWA20R	DIP Solder Headers ,90°, 4.20mm 2X10P 6A	0.638	0.579	0.492	0.456
PHA10	Receptacle connector, 4.20mm 2X5P 7A	0.231	0.210	0.178	0.165
PHA14	Receptacle connector, 4.20mm 2X7P 6A	0.312	0.283	0.241	0.223
PHA20	Receptacle connector, 4.20mm 2X10P 6A	0.432	0.392	0.333	0.308

PHD2	Wire to Board Connector 3.96mm 2P 7A/250V	0.039	0.036	0.030	0.028
PHD3	Wire to Board Connector 3.96mm 3P 7A/250V	0.059	0.053	0.045	0.042
PHD5	Wire to Board Connector 3.96mm 5P 7A/250V	0.098	0.089	0.076	0.070
PHD6	Wire to Board Connector 3.96mm 6P 7A/250V	0.117	0.107	0.091	0.084
PHD10	Wire to Board Connector 3.96mm 10P 7A/250V	0.196	0.178	0.151	0.140

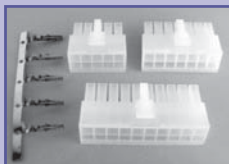

PHAx

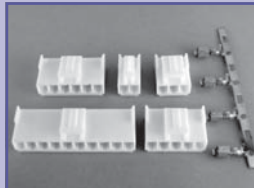

PHDxx

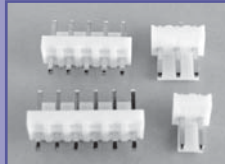

PWDxxS/R

Connectors		1-9	10-99	100-499	500+
PWD2S	Pin Header 3.96mm 2P 7A/250V	0.024	0.022	0.018	0.017
PWD2R	Pin Header 90°, 3.96mm 2P 7A/250V	0.028	0.026	0.022	0.020
PWD3S	Pin Header 3.96mm 3P 7A/250V	0.036	0.032	0.028	0.026
PWD3R	Pin Header 90°, 3.96mm 3P 7A/250V	0.042	0.038	0.033	0.030
PWD5S	Pin Header 3.96mm 5P 7A/250V	0.060	0.054	0.046	0.043
PWD5R	Pin Header 90°, 3.96mm 5P 7A/250V	0.073	0.066	0.056	0.052
PWD6S	Pin Header 3.96mm 6P 7A/250V	0.074	0.067	0.057	0.053
PWD6R	Pin Header 90°, 3.96mm 6P 7A/250V	0.092	0.084	0.071	0.066
PWD10S	Pin Header 3.96mm 10P 7A/250V	0.124	0.112	0.096	0.089
PWD10R	Pin Header 90°, 3.96mm 10P 7A/250V	0.152	0.138	0.117	0.109
C150-072P		3.484	3.097	2.761	2.580

Cable Ties		1-9	10-99	100-999	1000+
CT075-00	Cable Ties 75 mm	0.010	0.008	0.007	0.005
CT100(CV100)	Cable Ties 100mm x 2.5MM	0.016	0.012	0.010	0.008
CT0140-00	Cable Ties 140mm	0.019	0.015	0.014	0.011
CT165(CV165)	Cable Ties 165mm x 2.5MM	0.027	0.021	0.020	0.016
CTO200-025	Cable Ties 200mm x 2.5MM	0.028	0.022	0.021	0.017
CTO200-032	Cable Ties 200mm x 3.2MM	0.038	0.032	0.029	0.024
CTO250-048	Cable Ties 250mm x 4.8MM	0.056	0.050	0.043	0.040
CTO280-048	Cable Ties 280mm x 4.8MM	0.059	0.053	0.045	0.042
CT330(CV330)	Cable Ties 331mm x 3.6MM	0.065	0.059	0.050	0.046
TV100	Cable Ties 100mm	0.018	0.014	0.012	0.009
TV180	Cable Ties 180mm	0.044	0.035	0.032	0.026
TV280	Cable Ties 280mm	0.061	0.055	0.047	0.043

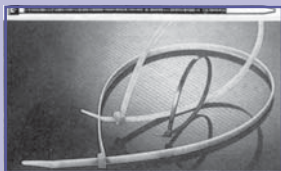

CTxxx-xx



TVxxx

Heat Shrinking Sleeve		1-4	5-24	25-99	100+
F32-10	Heat Shrinking Sleeve ϕ 10mm	0.928	0.846	0.743	0.688
F32-5	Heat Shrinking Sleeve ϕ 5mm	0.574	0.523	0.459	0.425
F32-7	Heat Shrinking Sleeve ϕ 7mm	0.708	0.646	0.567	0.525

Mechanical accessories		1-9	10-99	100-999	1000+
CS0610	Circuit Board Support 9.6mm	0.040	0.036	0.031	0.029
CS0813	Circuit Board Support 12.7mm	0.046	0.041	0.035	0.033
CS1016	Circuit Board Support 15.9mm	0.070	0.063	0.054	0.050
CS1219	Circuit Board Support 19.1mm	0.072	0.066	0.056	0.052
SB8	Snap Bushing ϕ 8	0.028	0.025	0.022	0.020
SB10	Snap Bushing ϕ 10	0.031	0.028	0.024	0.022
SR5R2	Snap Bushing with changeable diameter	0.054	0.049	0.041	0.038
PG16	Nylon Cable Gland PG-16	0.675	0.578	0.540	
PG20	Nylon Cable Gland PG-20	0.884	0.756	0.707	
PG1610	Nylon Cable Gland PG-1610	0.872	0.747	0.698	
PG2013	Nylon Cable Gland PG-2013	1.126	0.963	0.900	



CSxxxx



SBxx



PG16



PG20

Mechanical accessories

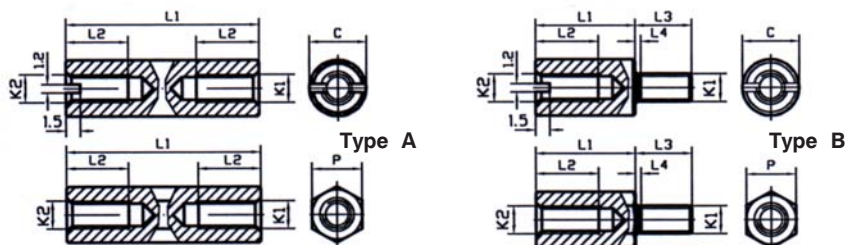

Thread	C	P	L1	L3	L2	L2	Material	Coating
M2	4: 4.5	4: 4.5	5: 6: 7: 8: 9: 10 12: 15	5	L2=L1	L1=5/L2=4 L1>5/L2=5	M F	- Z
M2.5	5:5.5	5:5.5	5:6:7:8:9:10: 12:15:20:25: 30:35:40:45: 50:55:60	6	L1<20/L2=L1 L1>15/L2=6	L1=5/L2=4 L1=6/L2=5 L1>6/L2=6	M F	- Z O
M3	5:5.5 6	5:5.5 6	5:6:7:8:9:10: 12:15:20:25: 30:35:40:45: 50:55:60	6	L1<20/L2=L1 L1>15/L2=6	L1=5/L2=4 L1=6/L2=5 L1>6/L2=6	M F	- Z O
M4	6:7: 7.5	6:7:	8:9:10:12:15: 20:25:30:35: 40:45:50:55: 60	7	L1<20/L2=L1 L1>15/L2=7	L1=8/L2=6 L1>8/L2=7	M F	- Z O

Brass - M
Steel - F
Aluminium - A
Zinc - Z
Oxidation - O



* - Non-compulsary parameter

KF6M3B4/3-10 Spacer, round, outer dia 6, brass, Zn-plated, Type B, outer thread M4, inner thread M3, length 10mm.

K5MA3-5 Spacer, hexagonal 5, brass, Type A, thread M3, length 5.

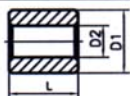

L=3:4:5:6:7:8:9:10:12
D1=5:5.5:6:7:7.5:8
D2=2.8:3.3:4.2
Materials M;F

DF8F04-12

Bush, round, outer dia 8, iron, oxidated, inne dia 4.2, length 12 mm.

	P	L1	L2		
M3	6	30: 35: 40: 45: 50: 55: 60	15: 16.5	M F	Z O
M4	7	33: 40: 45: 50: 55: 60	16.5	M F	Z O

KGMA4-60

Spacer, folded, brass, Type A, inner thread M4, length 60.

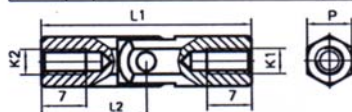

Materials M;F

MOTOMAT[®]
Mechanical Systems

Orders different from the above specifications
are also accepted.

Mechanical accessories

AL sinks, folded, for TO220, TO3P, SOT32 and Etc.

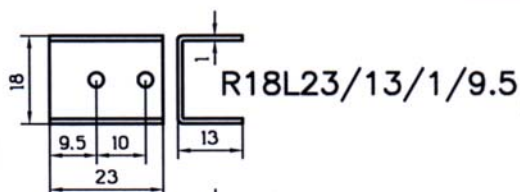
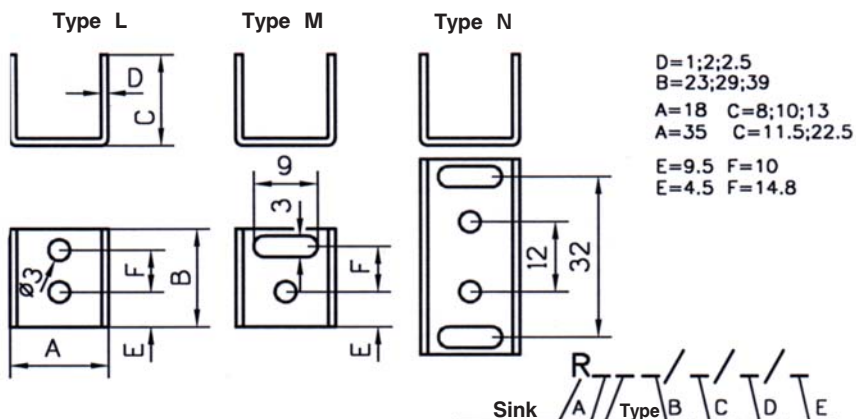

- Sink, width 18mm, Type L, length 23mm, height 13mm, thickness of the material 1mm, distance of the first opening from the edge 9.5mm.

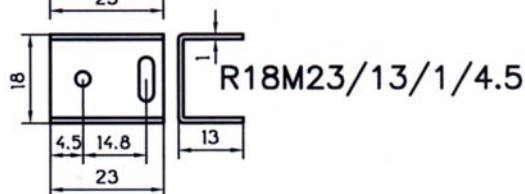

- Sink, width 18mm, type M, length 23mm, height 13mm, thickness of the material 1mm, distance of the first opening from the edge 4.5mm.

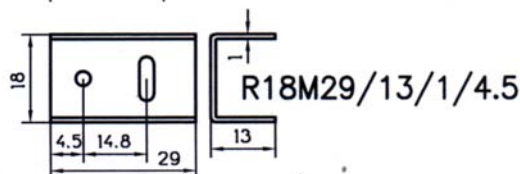

- Sink, width 18mm, Type M, length 29mm, height 13mm, thickness of the material 1mm, distance of the first opening from the edge 4.5mm.

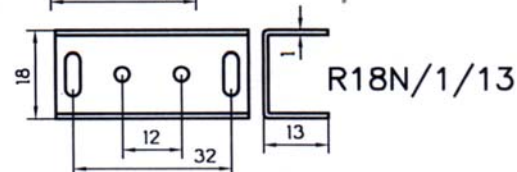

- Sink, width 18mm, Type N, height 13mm, thickness of the material 1mm.

MOTOMAT[®]
Mechanical Systems

Orders different from the above specifications
are also accepted.

Bobbins

		1-4	5-24	25-99	100+
E1274HDSF	EF12.6 x 7 x 4 (Hor) DS	0.127	0.113	0.104	0.094
E1274HBFF	EF12.6 x 7 x 4 Box With Feet	0.085	0.075	0.069	0.063
E1685HDSF	EF16 x 8 x 5 (Hor) DS	0.132	0.117	0.107	0.098
E1685HBFF	EF16 x 8 x 5 Box With Feet	0.091	0.081	0.074	0.067
E2010HDSG	EF20 x 10 x 6 (Hor) DS	0.201	0.178	0.164	0.149
E2010HPRF	EF20 (Hor) SS Primary Margin	0.215	0.191	0.176	0.160
E2010HSCF	EF20 (Hor) Secondary Cover	0.114	0.102	0.093	0.085
E2010HSPF	EF20 (Hor) Shield Plate	0.075	0.066	0.061	0.055
E2010VDSG	EF20 x 10 x 6 (Ver) DS	0.205	0.182	0.167	0.152
E2513HDEF	EF25 x 13 x 7 (Hor) DS (8 Pin)	0.222	0.197	0.181	0.164
E3015HDSG	E30 x 15 x 7 (Hor) DS	0.250	0.222	0.203	0.185
U30075DSF	UI 30 x 7.5 DS	0.275	0.244	0.224	0.203
U30075BSG	UI 30 x 7.5 Box	0.309	0.275	0.252	0.229
U30105DSF	UI 30 x 10.5 DS	0.280	0.249	0.228	0.207
U30105BSG	UI 30 x 10.5 Box	0.323	0.287	0.263	0.239
U39080DSF	UI 39 x 8.0 DS	0.312	0.277	0.254	0.231
U39080BSG	UI 39 x 8.0 Box	0.249	0.221	0.203	0.184
U39135DSF	UI 39 x 13.5 DS	0.325	0.289	0.265	0.240
U39135BSG	UI 39 x 13.5 Box	0.428	0.381	0.349	0.317
M30105DSG	MEI 30 x 10.5 DS Standard (23mm)	0.221	0.197	0.180	0.164
M30105BSG	MEI 30 x 10.5 Box Standard	0.176	0.156	0.143	0.130
M30125DSG	MEI 30 x 12.5 DS Standard (25mm)	0.223	0.198	0.181	0.165
M30125BSG	MEI 30 x 12.5 Box Standard	0.180	0.160	0.147	0.133
M30155DSG	MEI 30 x 15.5 DS Standard (28mm)	0.233	0.207	0.190	0.172
M30155BSG	MEI 30 x 15.5 Box Standard	0.143	0.127	0.116	0.106
M30180DSG	MEI 30 x 18.0 DS Standard (30.5mm)	0.237	0.211	0.193	0.175
M30180BSG	MEI 30 x 18.0 Box Standard	0.197	0.175	0.160	0.146
M38075SDG	MEI 38 x 7.5 SDS	0.250	0.222	0.204	0.185
M38136DSG	MEI 38 x 13.6 DS	0.256	0.228	0.209	0.190
M38200DSG	MEI 38 x 20 DS	0.284	0.252	0.231	0.210
M42148DSG	MEI 42 x 14.8 DS	0.292	0.260	0.238	0.216
M48168DSG	MEI 48 x 16.8 DS	0.311	0.276	0.253	0.230
M48208DSG	MEI 48 x 20.8 DS	0.330	0.293	0.269	0.244
M54188DSG	MEI 54 x 18.8 DS	0.391	0.348	0.319	0.290
M54255DSG	MEI 54 x 25.5 DS	0.402	0.358	0.328	0.298
SP-EF 32-1352-12B	50132091012A Coil Former	0.498	0.443	0.406	0.369
SP-RM14-1074-12B	522140010112 Coil Former	0.858	0.763	0.699	0.636
SP-E 30/11-1562-12B	51230111012U Coil Former	0.525	0.466	0.427	0.389
HK-RM 14-1309	700001401309 Long	0.245	0.218	0.200	0.182

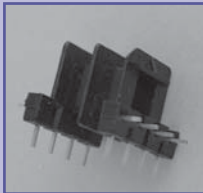

Exxxx

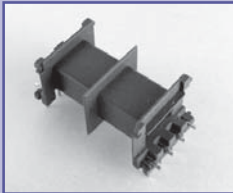

Uxxxx



Mxxxx

Switches

		1-9	10-99	100-499	500+
SS-12F15G3		0.090	0.067	0.057	0.048
SS-12F15G8		0.081	0.061	0.052	0.043
SS-12F15G9		0.090	0.067	0.057	0.048
SS-12F23G8		0.108	0.081	0.068	0.057
SS-12F44G8		0.083	0.063	0.053	0.044
SS-22F01G3		0.119	0.089	0.076	0.065
SS-22F01G9		0.123	0.092	0.078	0.067
SS-22F01AT12		0.141	0.106	0.090	0.077
SS-22F07G7		0.129	0.097	0.082	0.071
SS-22F07G9		0.131	0.098	0.083	0.072
SS-22F07AT9		0.146	0.109	0.093	0.080
SS-22F12G7		0.135	0.101	0.085	0.074
SS-22F12AT9		0.151	0.113	0.096	0.083
SS-22F25G3		0.124	0.093	0.079	0.068



SS-22F01G3



SS-22F01G9



SS-22F01AT12



SS-22F12G7

Switches

SS-22F25G9
 SS-22F32G3
 SS-22J01G0
 SS-22J01G9
 SS-22H02G4
 SS-22H02G7
 SS-23D03G4
 SS-23E01G3
 SS-23E01G7
 SS-23E01AT7
 SS-23F02G7
 SS-23H02G9
 SS-23H07G7
 SS-24F01G7
 SS-24F01AT7
 SS-24H04G7
 SS-24H04AT9
 SS-42F01G7
 SS-42H04G7
 SS-42H08G7
 SK-22F01G4
 SK-22F01G9
 SK-22F01AC8
 SK-22F01AT9
 SK-23E01G7
 SK-24F01G9



SS-22F07G7



SS-22F07AT9



SS-22F25G3



SS-22H02G4



SS-23H07G7



SS-24F01G7



SS-24H04AT9



SK-22F01G4

R13-23AB
 R13-23BB
 R13-66AB
 R13-66AW
 R13-66DB
 R13-130AB
 R13-136AB
 SA1131
 SB2095
 TA101A1
 TA103A1
 TA201A1
 TA203A1

switch 2p SPST OFF(ON) 13x34mm 3A/250V
 switch 2p SPST ON-OFF 13x34mm 1.5A/250V
 switch 2p SPST ON-OFF 13x18mm 6A/250V white
 switch 2p SPST ON-OFF 13x18mm 6A/250V black
 switch 2p SPDT ON-OFF-ON 21x15mm 3A/250V
 switch 2p SPST ON-OFF 25x19mm 6A/250V
 switch 2p SPST ON-OFF 25x18mm 6A/250V
 SA1131
 switch 4p DPST ON-OFF 18x32.4mm 10A/250V
 switch 2p SPST ON-OFF 9x6mm 3A/250V
 switch 2p SPST ON-OFF-ON 9x6mm 3A/250V
 switch 2p SPST ON-OFF 3P SPDT 9x6mm 3A/250V
 switch 2p SPST ON-OFF-ON 6P DPDT 9x6mm 3A/250V

1-9	10-99	100-499	500+
0.127	0.095	0.081	0.070
0.120	0.090	0.076	0.066
0.107	0.080	0.068	0.058
0.115	0.087	0.073	0.063
0.202	0.151	0.128	0.110
0.203	0.152	0.129	0.111
0.168	0.144	0.128	0.110
0.208	0.178	0.159	0.136
0.210	0.180	0.160	0.138
0.243	0.208	0.185	0.159
0.185	0.159	0.141	0.121
0.222	0.190	0.169	0.146
0.260	0.223	0.198	0.171
0.260	0.223	0.198	0.171
0.278	0.238	0.212	0.182
0.267	0.229	0.204	0.175
0.278	0.238	0.212	0.182
0.260	0.223	0.198	0.171
0.223	0.198	0.171	
0.244	0.209	0.186	0.160
0.127	0.095	0.081	0.070
0.129	0.097	0.082	0.071
0.144	0.108	0.092	0.079
0.141	0.106	0.090	0.077
0.251	0.188	0.160	0.137
0.280	0.210	0.178	0.153



R13-23xx



R13-66xx



R13-136AB



TA101A1

RS02
 RS04
 RS06
 RS07
 RS08
 RST04
 RST08
 ERD116CS
 ERD216CS
 ED1112S-12

DIP switch 2p
 DIP switch 4p
 DIP switch 6p
 DIP switch 7p
 DIP switch 8p
 DIP switch 4p 3 states
 DIP switch 8p 3 states
 HEX switch flat
 HEX switch axial
 rotary type encoder



RSxx

1-9	10-99	100-499	500+
0.366	0.336	0.318	0.300
0.396	0.363	0.344	0.324
0.422	0.387	0.366	0.346
0.484	0.444	0.420	0.396
0.422	0.387	0.367	0.346
0.818	0.751	0.711	0.671
1.042	0.957	0.906	0.854
1.416	1.329	1.242	
1.554	1.459	1.363	
1.151	1.026	0.959	

Switches

- TS-061 (TS-1)** *Tact switch 6x6 horizontal 4.4 mm*
- TS-062 (TS-2)** *Tact switch 6x6 horizontal 5.1 mm*
- TS-06E (TS-3)** *Tact switch 6x6 horizontal 7.0 mm*
- TS-064 (TS-4)** *Tact switch 6x6 horizontal 9.5 mm*
- TS-06D (TS-7G)** *Tact switch 6x6 horizontal 13 mm*

1-9 10-99 100-499 500+

0.053	0.045	0.041	0.039
0.053	0.045	0.041	0.039
0.055	0.047	0.043	0.041
0.051	0.043	0.040	0.038
0.067	0.057	0.052	0.050



TS-061(TS-1)



TS-062(TS-2)



TS-06E(TS-3)



TS-064(TS-4)



TS-06D(TS-7G)

- P6-1Y0** *push button key sw. yellow SPDT 12.4mm*
- P6-1L0** *push button key sw. blue SPDT 12.4mm*
- P6-1R1** *push button key sw. red SPST 12.4mm*
- P6-1R0** *push button key sw. red SPDT 12.4mm*
- P6-1E0** *push button key sw. green SPDT 12.4mm*
- P6-1B0** *push button key sw. black SPDT 12.4mm*
- P6-1W0** *push button key sw. white SPDT 12.4mm*

1-9 10-99 100-499 500+

0.486	0.435	0.420	0.389
0.486	0.435	0.420	0.389
0.486	0.435	0.420	0.389
0.486	0.435	0.420	0.389
0.486	0.435	0.420	0.389
0.486	0.435	0.420	0.389
0.486	0.435	0.420	0.389

- P1-0S** *push switch non lock 8x8, 2 contacts*
- P1-1S** *push switch lock 8x8, 2 contacts*
- P1-XX-1B** *top button sq.7x7x8mm black*
- P1-XX-1E** *top button sq.7x7x8mm green*
- P1-XX-1L** *top button sq.7x7x8mm blue*
- P1-XX-1R** *top button sq.7x7x8mm red*
- P1-XX-1W** *top button sq.7x7x8mm white*
- P1-XX-1Y** *top button sq.7x7x8mm yellow*
- P1-XX-3B** *top button round φ7x8mm black*
- P1-XX-3E** *top button round φ7x8mm green*
- P1-XX-3L** *top button round φ7x8mm blue*
- P1-XX-3R** *top button round φ7x8mm red*
- P1-XX-3W** *top button round φ7x8mm white*
- P1-XX-3Y** *top button round φ7x8mm yellow*

0.333	0.298	0.288	0.266
0.351	0.314	0.303	0.281
0.059	0.052	0.051	0.047
0.059	0.052	0.051	0.047
0.059	0.052	0.051	0.047
0.059	0.052	0.051	0.047
0.059	0.052	0.051	0.047
0.059	0.052	0.051	0.047
0.059	0.052	0.051	0.047
0.059	0.052	0.051	0.047
0.059	0.052	0.051	0.047
0.059	0.052	0.051	0.047
0.059	0.052	0.051	0.047
0.059	0.052	0.051	0.047

- P2-0S-RB** *push button sw. non lock red*
- P2-0S-EB** *push button sw. non lock green*
- P2-0S-YB** *push button sw. non lock yellow*
- P2-0S-RB-R** *push button sw. non lock red, red LED*
- P2-0S-EB-E** *push button sw. non lock green, gr. LED*
- P2-0S-LG-E** *push button sw. non lock blue, gr. LED*
- P2-0S-YB-Y** *push button sw. non lock yellow, yel. LED*
- P2-1S-RB** *push button sw. lock red*
- P2-1S-EB** *push button sw. lock green*
- P2-1S-YB** *push button sw. lock yellow*
- P2-1S-RB-R** *push button sw. lock red, red LED*
- P2-1S-EB-E** *push button sw. lock green, gr. LED*
- P2-1S-YB-Y** *push button sw. lock yellow, yel. LED*

0.593	0.531	0.512	0.474
0.593	0.531	0.512	0.474
0.593	0.531	0.512	0.474
0.753	0.674	0.650	0.602
0.753	0.674	0.650	0.602
0.753	0.674	0.650	0.602
0.753	0.674	0.650	0.602
0.646	0.578	0.558	0.516
0.646	0.578	0.558	0.516
0.646	0.578	0.558	0.516
0.811	0.726	0.700	0.649
0.811	0.726	0.700	0.649
0.811	0.726	0.700	0.649



P1-XX-1x



P1-xS



P1-XX-3x

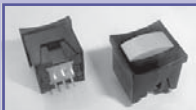

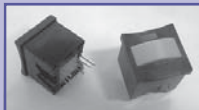

P2-xS-xx



P2-xS-xx-x

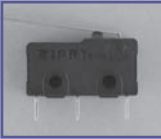

P6-xxx

Switches			1-9	10-99	100-499	500+	
SM-05S-03P		micro sw. 5A/250V AC 19.5x9.5x6.4mm, with lever	0.428	0.396	0.358	0.317	
VM-05S-00D0		micro sw. 5A/250V AC	0.671	0.601	0.580	0.537	
VM-05S-02D0		micro sw. 5A/250V AC with lever 27mm	0.707	0.633	0.611	0.565	
VMO10S0D0		micro sw. 10A/250V AC	0.643	0.576	0.555	0.514	
VMO10S02D0		micro sw. 10A/250V AC with lever 27mm	0.670	0.600	0.579	0.536	
							
SM-05S-03P	VMxxS-00D0	VMxxS-02D0	TF-0284				
				1-4	5-24	25-99	100+
TF0284	keypad			1.625	1.456	1.404	1.300
Indicator Lights			1-4	5-24	25-99	100+	
N-703	220V	RED	Indicator Light 12 mm Neon 220V	0.624	0.532	0.486	0.463
N-705L	12V	RED	Indicator Light 10 mm LED, 12V	0.588	0.501	0.458	0.436
N-705L	12V	GREEN	Indicator Light 10 mm LED, 12V	0.631	0.538	0.491	0.467
N-708L	12V	RED	Indicator Light 12 mm LED, 12V	0.638	0.543	0.496	0.472
N-802	220V	RED	Indicator Light 12x12 Neon 220V	0.359	0.306	0.279	0.266
N-802	220V	ORANGE	Indicator Light 12x12 Neon 220V	0.384	0.327	0.298	0.284
N-802P	12V	RED	Indicator Light 12x12 mm , 12V	0.439	0.374	0.342	0.325
N-802P	12V	ORANGE	Indicator Light 12x12 mm , 12V	0.439	0.374	0.342	0.325
N-804	220V	RED	Indicator Light 14 mm Neon 220V	0.359	0.306	0.279	0.266
N-804	220V	ORANGE	Indicator Light 14 mm Neon 220V	0.387	0.329	0.301	0.286
N-804	220V	O.GREEN	Indicator Light 14 mm Neon 220V	0.625	0.533	0.486	0.463
N-804	220V	N GREEN	Indicator Light 14 mm Neon 220V	0.365	0.311	0.284	0.270
N-804P	12V	RED	Indicator Light 14 mm , 12V	0.450	0.383	0.350	0.333
N-804P	12V	GREEN	Indicator Light 14 mm , 12V	0.446	0.380	0.347	0.330
N-809	220V	RED	Indicator Light 19 mm Neon 220V	0.398	0.339	0.309	0.295
N-809P-12V	RED		Indicator Light 19 mm , 12V	0.577	0.492	0.449	0.428
N-810-220V	RED		Indicator Light 20 mm Neon 220V	0.421	0.359	0.327	0.312
N-810P-12V	RED		Indicator Light 20 mm , 12V	0.532	0.453	0.414	0.394
N-813-12V	RED		Indicator Light 23x23 mm , 12V	0.719	0.613	0.559	0.533
N-813-220V	RED		Indicator Light 23x23 mm Neon 220V	0.524	0.446	0.407	0.388
N-814	220V	RED	Indicator Light 9 mm Neon 220V	0.359	0.306	0.279	0.266
N-814	220V	O. GREEN	Indicator Light 9 mm Neon 220V	0.632	0.538	0.491	0.468
N-814	220V	N GREEN	Indicator Light 9 mm Neon 220V	0.381	0.324	0.296	0.282
N-814	220V	ORANGE	Indicator Light 9 mm Neon 220V	0.337	0.287	0.262	0.250
N-814L-12V	RED		Indicator Light 9 mm LED, 12V	0.428	0.365	0.333	0.317
N-814L-12V	GREEN		Indicator Light 9 mm LED, 12V	0.473	0.403	0.368	0.350
N-814L-12V	ORANGE		Indicator Light 9 mm LED, 12V	0.451	0.384	0.351	0.334
N-814P-12V	RED		Indicator Light 9 mm , 12V	0.451	0.384	0.351	0.334
N-814P-12V	GREEN		Indicator Light 9 mm , 12V	0.451	0.384	0.351	0.334
N-814P-12V	ORANGE		Indicator Light 9 mm , 12V	0.451	0.384	0.351	0.334
N-815	220V	RED	Indicator Light 9x9 mm Neon 220V	0.367	0.313	0.286	0.272
N-815	220V	GREEN	Indicator Light 9x9 mm Neon 220V	0.388	0.330	0.302	0.287
N-815	220V	ORANGE	Indicator Light 9x9 mm Neon 220V	0.367	0.313	0.286	0.272
N-815L-12V	RED		Indicator Light 9x9 mm LED, 12V	0.461	0.393	0.359	0.342
N-815L-12V	GREEN		Indicator Light 9x9 mm LED, 12V	0.407	0.347	0.317	0.301
N-815L-12V	ORANGE		Indicator Light 9x9 mm LED, 12V	0.448	0.381	0.348	0.332
N-815P-12V	RED		Indicator Light 9x9 mm , 12V	0.451	0.384	0.351	0.334
N-815P-12V	GREEN		Indicator Light 9x9 mm , 12V	0.454	0.387	0.353	0.337
N-815P-12V	ORANGE		Indicator Light 9x9 mm , 12V	0.458	0.390	0.356	0.339
N-816	220V	RED	Indicator Light 10 mm Neon 220V	0.488	0.415	0.379	0.361
N-816	220V	GREEN	Indicator Light 10 mm Neon 220V	0.488	0.415	0.379	0.361
N-816L-12V	RED		Indicator Light 10 mm LED, 12V	0.623	0.531	0.485	0.462
N-816P-12V	RED		Indicator Light 10 mm , 12V	0.524	0.447	0.408	0.388
RTM3020		LED Holder ϕ 3mm Metal		0.523	0.446	0.407	0.388

Buzzers and Microphones

		1-24	25-99	100+
PB1221P	1.1-1.7V, 2048Hz, ϕ 12mm	0.238	0.230	0.202
PB3112	30Vp-p, 500-10KHz, ϕ 35mm	0.462	0.446	0.391
PF21N30P	3-30VDC, 3kHz, ϕ 24mm	1.276	1.233	1.082
PFD21N30P	3-30VDC, 3kHz, ϕ 24mm	1.466	1.416	1.242
PK12N40P	3-15VDC, 4.1kHz, ϕ 13.8mm	1.090	1.053	0.924
PK12N40PA	3-15VDC, 4.1kHz, ϕ 13.8mm	0.955	0.922	0.809
PK12N40PE	3-15VDC, 4.1kHz, ϕ 13.8mm	0.674	0.651	0.571
PK16N04WA-06V	4-8VDC, 0.4kHz, ϕ 22.5mm	1.396	1.349	1.183
PK20N38P	3-28VDC, 3.8kHz, ϕ 23.4mm	0.941	0.909	0.798
PK21N30P	1.5-30VDC, 3kHz, ϕ 24mm	0.933	0.901	0.791
PL21N30P	3-28VDC, 3kHz, ϕ 24mm	1.291	1.248	1.094
PLD21N30P	3-30VDC, 3kHz, ϕ 24mm	1.478	1.428	1.253
PLD27N25P	3-28VDC, 2.5kHz, ϕ 30mm	1.996	1.928	1.691
PMZ12490BD0	4.9kHz, 17nF, ϕ 12mm	0.167	0.161	0.141
PMZ15580BD0	5.8kHz, 10nF, ϕ 15mm	0.102	0.099	0.087
PMZ20380BI0	3.8kHz, 25nF, ϕ 20mm	0.138	0.133	0.117
PMZ35260BS	2.6kHz, 30nF, ϕ 35mm	0.267	0.258	0.226
PMZ50280BJ0	2.8kHz, 35nF, ϕ 50mm	0.320	0.310	0.272
PS520	12VDC, 2.5-3.5KHz, ϕ 37mm, constant tone	3.444	3.327	2.919
PS583	6-14VDC, 1.5-3.5KHz, ϕ 50mm	4.206	4.063	3.564
PT1240P	20Vp-p, 4.1KHz, ϕ 13.8mm	0.590	0.570	0.500
PT1250W	25Vp-p, 4.8KHz, ϕ 13.8mm	0.507	0.490	0.430
PT1540W	25Vp-p, 4KHz, ϕ 17mm	0.350	0.338	0.297
PT1540P	25Vp-p, 4KHz, ϕ 17mm	0.275	0.265	0.233
PT2030P	25Vp-p, 2-5KHz, ϕ 23mm	0.629	0.607	0.533
PT2038W	30Vp-p, 3.8KHz, ϕ 24mm	0.360	0.348	0.305
PT2040P	30Vp-p, 4KHz, ϕ 22mm	0.382	0.369	0.324
PT2130FP	1.5-30VDC, 3-5KHz, ϕ 24mm	0.496	0.479	0.420
PT3110P	30Vp-p, 0.6-1.6KHz, ϕ 34.5mm, tel.ringer	0.615	0.594	0.521
PT3110W	30Vp-p, 0.6-1.6KHz, ϕ 34.5mm, tel.ringer	0.360	0.348	0.305
PT4176P	30Vp-p, telephone ringer, ϕ 44mm	0.885	0.855	0.750
ECM30B	Microphone Condenser -61dB 9.83mm	0.239	0.231	0.202
ECM60PC	Microphone Condenser -64dB 9.83mm	0.245	0.236	0.207
TH310	Dynamic Transm./Receiver 150 Ohm ϕ 31mm	0.978	0.945	0.829

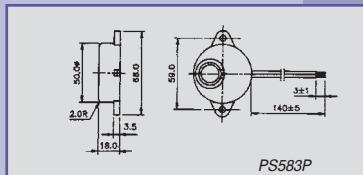
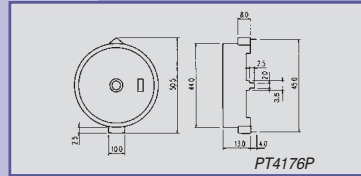
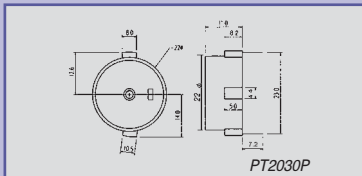
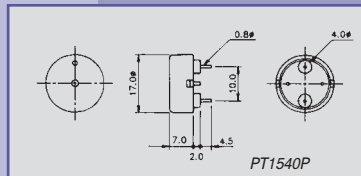
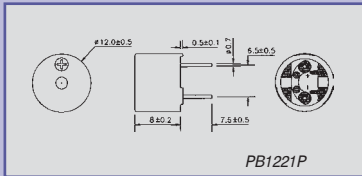

Crystals		1-9	10-99	100-499	500+
CT32768	32.768kHz 3X8 mm 30ppm 12.5pF	0.087	0.078	0.073	0.065
CT32768 SMD	32.768kHz SMD	0.463	0.427	0.362	
1.000MHz	crystal 1.000MHz HC49U	1.170	1.075	0.959	
1.8432 MHz	crystal 1.8432 MHz HC49U	0.513	0.472	0.400	
3.2768MHz	crystal 3.2768 MHz HC49U	0.221	0.201	0.177	0.164
3.5795MHz	crystal 3.5795MHz HC49U	0.221	0.201	0.177	0.164
3.6864MHz	crystal 3.6864MHz HC49U	0.239	0.217	0.191	0.177
4.000MHz	crystal 4.000MHz HC49U	0.221	0.201	0.177	0.164
4.000MHz HC-49S	crystal 4.000MHz HC49S	0.279	0.255	0.224	0.207
4.6080MHz	crystal 4.6080MHz HC49U	0.289	0.263	0.231	0.214
4.1943MHz	crystal 4.1943MHz HC49U	0.244	0.222	0.195	0.181
4.4336MHz	crystal 4.4336MHz HC49U	0.251	0.229	0.201	0.186
4.9152MHz	crystal 4.9152MHz HC49U	0.284	0.258	0.227	0.210
5.000MHz	crystal 5.000MHz HC49U	0.289	0.263	0.231	0.214
6.000MHz	crystal 6.000MHz HC49U	0.311	0.283	0.248	0.230
6.400MHz	crystal 6.400MHz HC49U	0.221	0.201	0.177	0.164
7.20MHz	crystal 7.20MHz HC49U	0.311	0.283	0.248	0.230
8.000MHz	crystal 8.000MHz HC49U	0.221	0.201	0.177	0.164
8.867MHz	crystal 8.867MHz HC49U	0.289	0.263	0.231	0.214
10.000MHz	crystal 10.000MHz HC49U	0.221	0.201	0.177	0.164
10.000MHz HC-49S	crystal 10.000MHz HC49S	0.279	0.255	0.224	0.207
10.245MHz	crystal 10.245MHz HC49U	0.221	0.201	0.177	0.164
11.059MHz	crystal 11.059MHz HC49U	0.234	0.213	0.187	0.173
11.059MHz HC-49S	crystal 11.059MHz HC49S	0.279	0.255	0.224	0.207
12.000MHz	crystal 12.000MHz HC49U	0.221	0.201	0.177	0.164
12.000MHz HC-49S	crystal 12.000MHz HC49S	0.279	0.255	0.224	0.207
16.000MHz	crystal 16.000MHz HC49U	0.225	0.205	0.180	0.166
16.000MHz HC-49S	crystal 12.000MHz HC49S	0.279	0.255	0.224	0.207
16.670MHz	crystal 16.670MHz HC49U	0.000	0.000	0.000	0.000
17.900MHz	crystal 17.900MHz HC49U	0.000	0.000	0.000	0.000
18.432MHz	crystal 18.432MHz HC49U	0.221	0.201	0.177	0.164
20.000MHz	crystal 20.000MHz HC49U	0.221	0.202	0.177	0.164
20.000MHz HC-49S	crystal 20.000MHz HC49S	0.255	0.232	0.204	0.189
24.000MHz Fund	crystal 24.000MHz Fund HC49U	0.264	0.240	0.211	0.195
Quartz Oscillators		1-24	25-99	100+	
OSC14.318MHz		0.547	0.502	0.449	
OSC16.00MHz		0.547	0.502	0.449	
OSC20.00MHz		0.547	0.502	0.449	
Ceramic Resonators and Filters		1-9	10-99	100-499	500+
CR1000	Cer.Res.1MHz 0.5%/25C, +/-0.3% -20+80C	0.238	0.201	0.179	0.149
CRM0358	Cer.Res.3.58MHz 0.5%/25C, +/-0.3% -20+80C	0.083	0.070	0.062	0.052
CRM0400	Cer.res.4MHz 0.5%/25C, +/-0.3% -20+80C	0.102	0.086	0.077	0.064
CRMX0400	Cer.r.4MHz 0.5%/25C, +/-0.5% -20+80C, 2x30pF	0.131	0.110	0.098	0.082
CRM0800	Cer.res.8MHz 0.5%/25C, +/-0.5% -20+80C	0.124	0.105	0.093	0.078
MSU455FA	Cer.filter 455KHz +/-2kHz 3dB BW 10kHz	0.184	0.155	0.138	0.115
CF5.5MHz	Cer.filter 5.5MHz	0.177	0.157	0.136	
CF6.0MHz	Cer.filter 6.0MHz	0.177	0.157	0.136	
CF6.5MHz	Cer.filter6.5MHz	0.131	0.116	0.101	
CF10.7MHz	Cer.filter 10.7MHz	0.113	0.095	0.085	0.071
Ferrite Cores KASCHKE		1-4	5-24	25-99	100+
E13/4 K2006	AL 850 f 10-100kHz Ae 12.4mm2 Br 0.2T	0.232	0.198	0.189	0.172
E20/6 (EF20/5.9) K2004	AL 1300 f 10-100kHz Ae 32mm2 Br 0.2T	0.241	0.205	0.197	0.179
E20/6 (EF20/5.9) K2006	AL 1300 f 10-100kHz Ae 32mm2 Br 0.2T	0.286	0.243	0.233	0.212
E20/11(EF20/11) K2006	AL 2600 f 25-300kHz Ae 60mm2 Br 0.2T	0.297	0.253	0.242	0.220
E25/7(EF25/7.5) K2006	AL 3200 f 25-300kHz Ae 52mm2 Br 0.2T	0.235	0.200	0.191	0.174
E25/11(11mL1) K2006	AL 3200 f 25-300kHz Ae 76.5mm2 Br 0.2T	0.197	0.168	0.161	0.146
E30/11 K2006	AL 2700 f 25-300kHz Ae 91.2mm2 Br 0.2T	0.407	0.346	0.331	0.301
E32/9 (EF32/9.5) K2006	AL 2200 f 25-300kHz Ae 83mm2 Br 0.2T	0.422	0.360	0.344	0.313
E42/20 K2004	AL 5100 f 25-300kHz Ae 233mm2 Br 0.2T	0.821	0.699	0.669	0.608
E55/21 K2004	AL 5800 f 10-100kHz Ae 350mm2 Br 0.2T	1.751	1.549	1.482	1.347
E65/27 K2004	AL 7200 f 10-100kHz Ae 540mm2 Br 0.2T	3.092	2.735	2.616	2.378
E80/20 K2004	AL 4150 f 10-100kHz Ae 390mm2 Br 0.2T	3.234	2.898	2.794	2.587
E100/28 K2004	AL 5500 f 10-100kHz Ae 785 mm2 Br 0.2T	9.612	8.612	8.304	7.689

Ferrite Cores KASCHKE		1-4	5-24	25-99	100+
R6.3/3.8/2.5 K4000	AL 1000 Ae 31.2mm ³	0.123	0.104	0.097	0.088
R6.3/3.8/2.5 K10000	AL 2500 Ae 31.2mm ³	0.144	0.123	0.117	0.107
R8/4/3 K10000	AL 4150 Ae 5.73mm ³	0.159	0.136	0.130	0.118
R10/6/4 K10000	AL 4050 Ae 7.75mm ³	0.176	0.150	0.144	0.131
R25/15/10 L K2004	AL 2000 f 20-100kHz Ae 48.7mm ³	0.411	0.364	0.348	0.316
R34/20.5/12.5 K2004	AL 2500 f 20-100kHz Ae 82.5mm ²	1.243	1.099	1.051	0.956
R40/24/16 L K2006	AL 3400 f 25-300kHz Ae 124.7mm ³	1.616	1.430	1.368	1.243
RM14-OML K2006 set	AL 3400 f 25-300kHz Ae 124.7mm ³	2.246	1.987	1.900	1.728
R.F. Coils		1-9	10-99	100-499	500+
BFCS-5 0.33 uH 8218	0.33uH+/-3%min, Q30/25MHz	0.233	0.211	0.180	0.166
BFCS-5 0.47 uH 8219	0.47uH+/-3%min, Q30/25MHz	0.233	0.211	0.180	0.166
BFCS-5 1.0 uH 8220	1uH+/-3%min, Q30/25MHz	0.233	0.211	0.180	0.166
AF5 1mH/120pF 8221	1mH+/-3%min, 120pF+/-5%, Q35/252kHz	0.287	0.260	0.221	0.205
KHS-6 0.1 uH 1241	0.1uH+/-3%min, Q30/25MHz	0.270	0.245	0.208	0.193
KHS-6 0.18uH 1242	0.18uH+/-3%min, Q40/25MHz	0.270	0.245	0.208	0.193
KHS-6 1.0 uH 2593	1.0uH+/-6%min, Q50/25.2MHz	0.270	0.245	0.208	0.193
KHS-6 10 uH 1070	10uH+/-6%min, Q30/25.2MHz	0.270	0.245	0.208	0.193
KHS-6 2.7uH 1243	2.7uH+/-3%min, Q35/25MHz	0.270	0.245	0.208	0.193
KHS-7 0.33uH/12pF 8222	0.33uH+/-6%min, 12pF+/-10%, Q55/25MHz	0.270	0.245	0.208	0.193
FT39 1 1/2 - 845741	1 1/2 turns, for 433 MHz, Qmin 40/100MHz	0.091	0.083	0.070	0.065
FT39 2 1/2 - 863019	2 1/2 turns	0.091	0.083	0.070	0.065
FT39 3 1/2 - 863020	3 1/2 turns	0.091	0.083	0.070	0.065
OS45 150uH 0846	150uH+/-6%min, Q65/1MHz	0.132	0.120	0.102	0.095
OS45 470uH 1034	470uH+/-6%min, Q40/796kHz	0.133	0.121	0.103	0.095
OS45 1.0mH 1033	1mH+/-6%min, Q60/796kHz	0.137	0.124	0.106	0.098
Fixed Inductors		1-9	10-99	100-499	500+
CL1.0uH CEC	inductor 1.0uH 0.8 ohm 270mA 20%	0.040	0.036	0.031	0.029
CL2.2uH CEC	inductor 2.2uH 1.2 ohm 230mA 20%	0.040	0.036	0.031	0.029
CL0.1uH CECS	inductor 0.1uH 0.14 ohm 400mA 20%	0.053	0.048	0.041	0.038
CL0.22uH CECS	inductor 0.22uH 0.22 ohm 400mA 20%	0.053	0.048	0.041	0.038
CL0.47uH CECS	inductor 0.47uH 0.31 ohm 330mA 20%	0.053	0.048	0.041	0.038
CL1.0uH CECS	inductor 1.0uH 0.61 ohm 265mA 20%	0.053	0.048	0.041	0.038
CL2.2uH CECS	inductor 2.2uH 0.89 ohm 215mA 10%	0.053	0.048	0.041	0.038
CL3.3uH CECS	inductor 3.3uH 1.08 ohm 205mA 10%	0.053	0.048	0.041	0.038
CL4.7uH CECS	inductor 4.7uH 1.28 ohm 175mA 10%	0.053	0.048	0.041	0.038
CL10uH CECS	inductor 10uH 2.71 ohm 140mA 10%	0.053	0.048	0.041	0.038
CL22uH CECS	inductor 22uH 4.04 ohm 115mA 10%	0.053	0.048	0.041	0.038
CL47uH CECS	inductor 47uH 7.85 ohm 75mA 10%	0.053	0.048	0.041	0.038
CL100uH CECS	inductor 100uH 12.7 ohm 50mA 10%	0.053	0.048	0.041	0.038
CL220uH CECS	inductor 220uH 20.6 ohm 31mA 10%	0.053	0.048	0.041	0.038
CL1.0uH CECL	inductor 1.0uH 0.18 ohm 1500mA 20%	0.048	0.044	0.037	0.035
CL1.5uH CECL	inductor 1.5uH 0.22 ohm 1350mA 20%	0.048	0.044	0.037	0.035
CL2.2uH CECL	inductor 2.2uH 0.27 ohm 1180mA 20%	0.048	0.044	0.037	0.035
CL3.3uH CECL	inductor 3.3uH 0.34 ohm 1050mA 10%	0.048	0.044	0.037	0.035
CL4.7uH CECL	inductor 4.7uH 0.38 ohm 930mA 10%	0.048	0.044	0.037	0.035
CL6.8uH CECL	inductor 6.8uH 0.45 ohm 860mA 10%	0.048	0.044	0.037	0.035

Fixed Inductors

			1-9	10-99	100-499	500+
CL10uH	CECL	inductor 10uH 0.6 ohm 680mA 10%	0.048	0.044	0.037	0.035
CL15uH	CECL	inductor 15uH 0.74 ohm 620mA 10%	0.048	0.044	0.037	0.035
CL22uH	CECL	inductor 22uH 0.85 ohm 500mA 10%	0.048	0.044	0.037	0.035
CL33uH	CECL	inductor 33uH 1.1 ohm 485mA 10%	0.048	0.044	0.037	0.035
CL47uH	CECL	inductor 47uH 2.1 ohm 375mA 10%	0.048	0.044	0.037	0.035
CL68uH	CECL	inductor 68uH 2.5 ohm 330mA 10%	0.048	0.044	0.037	0.035
CL100uH	CECL	inductor 100uH 3.8 ohm 260mA 10%	0.048	0.044	0.037	0.035
CL150uH	CECL	inductor 150uH 5 ohm 225mA 10%	0.048	0.044	0.037	0.035
CL220uH	CECL	inductor 220uH 6.15 ohm 200mA 10%	0.048	0.044	0.037	0.035
CL330uH	CECL	inductor 330uH 7.7 ohm 175mA 10%	0.048	0.044	0.037	0.035
CL470uH	CECL	inductor 470uH 11.9 ohm 155mA 10%	0.048	0.044	0.037	0.035
CL680uH	CECL	inductor 680uH 15.1 ohm 140mA 10%	0.048	0.044	0.037	0.035
CL1.0mH	CECL	inductor 1mH 21 ohm 115mA 10%	0.048	0.044	0.037	0.035
CL1.5mH	CECL	inductor 1.5mH 44.5 ohm 80mA 10%	0.048	0.044	0.037	0.035

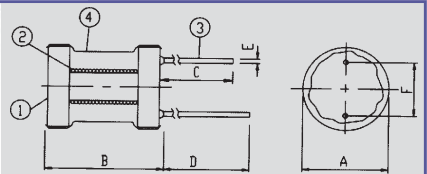

DIMENSION (UNIT :mm)

MODEL	A	B	C	D	E	F
SW45	4.2	7.0	10	15	0.5	1.8
SW68	6.2	9.5	10	15	0.6	3.0
CW8A	9	13	5	10	15	0.6

MATERIAL FOR CHOKE COILS

PRODUCT	MATERIAL
1. Core	Ferrite core
2. Wire	Polyurethane enameled copper wires
3. Lead wire	Soldered copper wires
4. Tube	Heat shrinkable tube, PVC or UL
5. Glue	Epoxy resin

			1-9	10-99	100-499	500+
CL1.0uH	SW45	inductor 1.0uH 0.1 ohm 1400mA 10%	0.065	0.059	0.050	0.046
CL1.5uH	SW45	inductor 1.5uH 0.15 ohm 1200mA 10%	0.065	0.059	0.050	0.046
CL2.2uH	SW45	inductor 2.2uH 0.2 ohm 1100mA 10%	0.065	0.059	0.050	0.046
CL3.3uH	SW45	inductor 3.3uH 0.22 ohm 1000mA 10%	0.065	0.059	0.050	0.046
CL4.7uH	SW45	inductor 4.7uH 0.26 ohm 800mA 10%	0.065	0.059	0.050	0.046
CL6.8uH	SW45	inductor 6.8uH 0.3 ohm 800mA 10%	0.065	0.059	0.050	0.046
CL10uH	SW45	inductor 10uH 0.46 ohm 700mA 10%	0.065	0.059	0.050	0.046
CL15uH	SW45	inductor 15uH 0.55 ohm 600mA 10%	0.065	0.059	0.050	0.046
CL22uH	SW45	inductor 22uH 0.72 ohm 500mA 10%	0.065	0.059	0.050	0.046
CL33uH	SW45	inductor 33uH 0.87 ohm 400mA 10%	0.065	0.059	0.050	0.046
CL47uH	SW45	inductor 47uH 1 ohm 400mA 10%	0.065	0.059	0.050	0.046
CL68uH	SW45	inductor 68uH 1.9 ohm 300mA 10%	0.065	0.059	0.050	0.046
CL100uH	SW45	inductor 100uH 3 ohm 200mA 10%	0.065	0.059	0.050	0.046
CL150uH	SW45	inductor 150uH 4.5 ohm 200mA 10%	0.065	0.059	0.050	0.046
CL220uH	SW45	inductor 220uH 5.8 ohm 200mA 10%	0.065	0.059	0.050	0.046
CL330uH	SW45	inductor 330uH 7 ohm 150mA 10%	0.065	0.059	0.050	0.046
CL470uH	SW45	inductor 470uH 8 ohm 120mA 10%	0.065	0.059	0.050	0.046
CL680uH	SW45	inductor 680uH 9.5 ohm 120mA 10%	0.065	0.059	0.050	0.046
CL1.0mH	SW45	inductor 1mH 17 ohm 100mA 10%	0.065	0.059	0.050	0.046
CL1.5mH	SW45	inductor 1.5mH 22 ohm 80mA 10%	0.065	0.059	0.050	0.046
CL2.2mH	SW45	inductor 2.2mH 26 ohm 60mA 10%	0.065	0.059	0.050	0.046

Fixed Inductors			1-9	10-99	100-499	500+	
CL10uH	SW68	inductor 10uH 0.09 ohm 1300mA 10%	0.086	0.078	0.066	0.061	
CL15uH	SW68	inductor 15uH 0.11 ohm 1050mA 10%	0.086	0.078	0.066	0.061	
CL22uH	SW68	inductor 22uH 0.12 ohm 960mA 10%	0.086	0.078	0.066	0.061	
CL33uH	SW68	inductor 33uH 0.19 ohm 800mA 10%	0.086	0.078	0.066	0.061	
CL47uH	SW68	inductor 47uH 0.23 ohm 830mA 10%	0.086	0.078	0.066	0.061	
CL68uH	SW68	inductor 68uH 0.37 ohm 750mA 10%	0.086	0.078	0.066	0.061	
CL100uH	SW68	inductor 100uH 0.44 ohm 710mA 10%	0.086	0.078	0.066	0.061	
CL150uH	SW68	inductor 150uH 0.73 ohm 600mA 10%	0.086	0.078	0.066	0.061	
CL220uH	SW68	inductor 220uH 0.92 ohm 450mA 10%	0.086	0.078	0.066	0.061	
CL330uH	SW68	inductor 330uH 0.15 ohm 400mA 10%	0.086	0.078	0.066	0.061	
CL470uH	SW68	inductor 470uH 0.82 ohm 340mA 10%	0.086	0.078	0.066	0.061	
CL680uH	SW68	inductor 680uH 3.25 ohm 250mA 10%	0.086	0.078	0.066	0.061	
CL1.0mH	SW68	inductor 1mH 4.55 ohm 210mA 10%	0.086	0.078	0.066	0.061	
CL1.5mH	SW68	inductor 1.5mH 7.54 ohm 180mA 10%	0.086	0.078	0.066	0.061	
CL2.2mH	SW68	inductor 2.2mH 8.32 ohm 150mA 10%	0.086	0.078	0.066	0.061	
CL3.3mH	SW68	inductor 3.3mH 10.92 ohm 130mA 10%	0.086	0.078	0.066	0.061	
CL4.7mH	SW68	inductor 4.7mH 17.81 ohm 85mA 10%	0.086	0.078	0.066	0.061	
CL6.8mH	SW68	inductor 6.8mH 27.3 ohm 65mA 10%	0.086	0.078	0.066	0.061	
CL10mH	SW68	inductor 10mH 39 ohm 58mA 10%	0.086	0.078	0.066	0.061	
CL15mH	SW68	inductor 15mH 65 ohm 53mA 10%	0.086	0.078	0.066	0.061	
CL22mH	SW68	inductor 22mH 82.55 ohm 46mA 10%	0.086	0.078	0.066	0.061	
CL33mH	SW68	inductor 33mH 135.2 ohm 38mA 10%	0.086	0.078	0.066	0.061	
CL47mH	SW68	inductor 47mH 172.9 ohm 35mA 10%	0.086	0.078	0.066	0.061	
CL100uH	CW8A	axial choke coil 100uH 0.29 ohm 1200mA 10%	0.116	0.105	0.090	0.083	
CL100uH	RBQE	inductor 100uH 0.06 ohm 3000mA 20%	0.416	0.368	0.320		
CL220uH	RBQE	inductor 220uH 0.099 ohm 3000mA 20%	0.452	0.400	0.348		
CL330uH	RBQE	inductor 330uH 0.144 ohm 1000mA 20%	0.445	0.393	0.342		
Varistors			1-9	10-99	100-499	500+	
VAR 7K391	250V AC	var. 7mm390V/1mA Uacmax250V/Udcmax320V	0.071	0.057	0.053	0.050	
VAR10K391	250V AC	var. 10mm390V/1mA Uacmax250V/Udcmax320V	0.110	0.088	0.081	0.078	
VAR14K391	250V AC	var. 14mm390V/1mA Uacmax250V/Udcmax320V	0.207	0.167	0.154	0.147	
VAR12K471	300V AC	var. 12mm470V/1mA Uacmax300V/Udcmax385V	0.179	0.145	0.133	0.127	
Resistors			1-19	20-99	100-499	500-4999	5000+
Resistor carbon film 0.125W 5%							
RW125CF	1.0E	resistor carbon film 0.125W 5%300ppm1.0E	0.0091	0.0036	0.0023	0.0020	0.0018
RW125CF	1.5E	resistor carbon film 0.125W 5%300ppm1.5E	0.0091	0.0036	0.0023	0.0020	0.0018
RW125CF	2.2E	resistor carbon film 0.125W 5%300ppm2.2E	0.0091	0.0036	0.0023	0.0020	0.0018
RW125CF	3.3E	resistor carbon film 0.125W 5%300ppm3.3E	0.0091	0.0036	0.0023	0.0020	0.0018
RW125CF	4.7E	resistor carbon film 0.125W 5%300ppm4.7E	0.0091	0.0036	0.0023	0.0020	0.0018
RW125CF	6.8E	resistor carbon film 0.125W 5%300ppm6.8E	0.0091	0.0036	0.0023	0.0020	0.0018
RW125CF	10E	resistor carbon film 0.125W 5%450ppm10E	0.0091	0.0036	0.0023	0.0020	0.0018
RW125CF	15E	resistor carbon film 0.125W 5%450ppm15E	0.0091	0.0036	0.0023	0.0020	0.0018
RW125CF	22E	resistor carbon film 0.125W 5%450ppm22E	0.0091	0.0036	0.0023	0.0020	0.0018
RW125CF	33E	resistor carbon film 0.125W 5%450ppm33E	0.0091	0.0036	0.0023	0.0020	0.0018
RW125CF	47E	resistor carbon film 0.125W 5%450ppm47E	0.0091	0.0036	0.0023	0.0020	0.0018
RW125CF	68E	resistor carbon film 0.125W 5%450ppm68E	0.0091	0.0036	0.0023	0.0020	0.0018
RW125CF	75E	resistor carbon film 0.125W 5%450ppm75E	0.0091	0.0036	0.0023	0.0020	0.0018
RW125CF	100E	resistor carbon film 0.125W 5%450ppm100E	0.0091	0.0036	0.0023	0.0020	0.0018
RW125CF	150E	resistor carbon film 0.125W 5%450ppm150E	0.0091	0.0036	0.0023	0.0020	0.0018
RW125CF	220E	resistor carbon film 0.125W 5%450ppm220E	0.0091	0.0036	0.0023	0.0020	0.0018
RW125CF	270E	resistor carbon film 0.125W 5%450ppm270E	0.0091	0.0036	0.0023	0.0020	0.0018
RW125CF	330E	resistor carbon film 0.125W 5%450ppm330E	0.0091	0.0036	0.0023	0.0020	0.0018
RW125CF	470E	resistor carbon film 0.125W 5%450ppm470E	0.0091	0.0036	0.0023	0.0020	0.0018
RW125CF	560E	resistor carbon film 0.125W 5%450ppm560E	0.0091	0.0036	0.0023	0.0020	0.0018
RW125CF	680E	resistor carbon film 0.125W 5%450ppm680E	0.0091	0.0036	0.0023	0.0020	0.0018
RW125CF	820E	resistor carbon film 0.125W 5%450ppm820E	0.0091	0.0036	0.0023	0.0020	0.0018
RW125CF	1.0K	resistor carbon film 0.125W 5%450ppm1.0K	0.0091	0.0036	0.0023	0.0020	0.0018
RW125CF	1.2K	resistor carbon film 0.125W 5%450ppm1.2K	0.0091	0.0036	0.0023	0.0020	0.0018
RW125CF	1.5K	resistor carbon film 0.125W 5%450ppm1.5K	0.0091	0.0036	0.0023	0.0020	0.0018
RW125CF	1.8K	resistor carbon film 0.125W 5%450ppm1.8K	0.0091	0.0036	0.0023	0.0020	0.0018
RW125CF	2.0K	resistor carbon film 0.125W 5%450ppm2.0K	0.0091	0.0036	0.0023	0.0020	0.0018
RW125CF	2.2K	resistor carbon film 0.125W 5%450ppm2.2K	0.0091	0.0036	0.0023	0.0020	0.0018
RW125CF	2.7K	resistor carbon film 0.125W 5%450ppm2.7K	0.0091	0.0036	0.0023	0.0020	0.0018

Resistors

		1-19	20-99	100-499	500-4999	5000+
RW6MF 82K	resistor metal film 0.6W 5%200ppm 82K	0.0119	0.0084	0.0073	0.0069	0.0060
RW6MF 100K	resistor metal film 0.6W 5%200ppm 100K	0.0119	0.0084	0.0073	0.0069	0.0060
RW6MF 120K	resistor metal film 0.6W 5%200ppm 120K	0.0119	0.0084	0.0073	0.0069	0.0060
RW6MF 150K	resistor metal film 0.6W 5%200ppm 150K	0.0119	0.0084	0.0073	0.0069	0.0060
RW6MF 180K	resistor metal film 0.6W 5%200ppm 180K	0.0119	0.0084	0.0073	0.0069	0.0060
RW6MF 220K	resistor metal film 0.6W 5%200ppm 220K	0.0119	0.0084	0.0073	0.0069	0.0060
RW6MF 270K	resistor metal film 0.6W 5%200ppm 270K	0.0119	0.0084	0.0073	0.0069	0.0060
RW6MF 330K	resistor metal film 0.6W 5%200ppm 330K	0.0119	0.0084	0.0073	0.0069	0.0060
RW6MF 390K	resistor metal film 0.6W 5%200ppm 390K	0.0119	0.0084	0.0073	0.0069	0.0060
RW6MF 470K	resistor metal film 0.6W 5%200ppm 470K	0.0119	0.0084	0.0073	0.0069	0.0060
RW6MF 560K	resistor metal film 0.6W 5%200ppm 560K	0.0119	0.0084	0.0073	0.0069	0.0060
RW6MF 680K	resistor metal film 0.6W 5%200ppm 680K	0.0119	0.0084	0.0073	0.0069	0.0060
RW6MF 820K	resistor metal film 0.6W 5%200ppm 820K	0.0119	0.0084	0.0073	0.0069	0.0060
RW6MF 1.0M	resistor metal film 0.6W 5%200ppm 1.0M	0.0119	0.0084	0.0073	0.0069	0.0060
<u>Resistor metal oxide 1W 5%</u>						
R1WMO 0.33E	resistor metal oxide 1W 5% 350ppm 0.33E	0.0321	0.0225	0.0196	0.0184	0.0160
R1WMO 0.47E	resistor metal oxide 1W 5% 350ppm 0.47E	0.0321	0.0225	0.0196	0.0184	0.0160
R1WMO 0.68E	resistor metal oxide 1W 5% 350ppm 0.68E	0.0321	0.0225	0.0196	0.0184	0.0160
<u>Resistor carbon film 1W 5%</u>						
R1WCF 1.0E	resistor carbon film 1W 5% 300ppm 1.0E	0.0267	0.0187	0.0163	0.0153	0.0133
R1WCF 1.2E	resistor carbon film 1W 5% 300ppm 1.2E	0.0267	0.0187	0.0163	0.0153	0.0133
R1WCF 1.5E	resistor carbon film 1W 5% 300ppm 1.5E	0.0267	0.0187	0.0163	0.0153	0.0133
R1WCF 1.8E	resistor carbon film 1W 5% 300ppm 1.8E	0.0267	0.0187	0.0163	0.0153	0.0133
R1WCF 2.2E	resistor carbon film 1W 5% 300ppm 2.2E	0.0267	0.0187	0.0163	0.0153	0.0133
R1WCF 2.7E	resistor carbon film 1W 5% 300ppm 2.7E	0.0267	0.0187	0.0163	0.0153	0.0133
R1WCF 3.3E	resistor carbon film 1W 5% 300ppm 3.3E	0.0267	0.0187	0.0163	0.0153	0.0133
R1WCF 3.9E	resistor carbon film 1W 5% 300ppm 3.9E	0.0267	0.0187	0.0163	0.0153	0.0133
R1WCF 4.7E	resistor carbon film 1W 5% 300ppm 4.7E	0.0267	0.0187	0.0163	0.0153	0.0133
R1WCF 5.6E	resistor carbon film 1W 5% 300ppm 5.6E	0.0267	0.0187	0.0163	0.0153	0.0133
R1WCF 6.8E	resistor carbon film 1W 5% 300ppm 6.8E	0.0267	0.0187	0.0163	0.0153	0.0133
R1WCF 8.2E	resistor carbon film 1W 5% 300ppm 8.2E	0.0267	0.0187	0.0163	0.0153	0.0133
R1WCF 10E	resistor carbon film 1W 5% 300ppm 10E	0.0267	0.0187	0.0163	0.0153	0.0133
R1WCF 15E	resistor carbon film 1W 5% 450ppm 15E	0.0267	0.0187	0.0163	0.0153	0.0133
R1WCF 22E	resistor carbon film 1W 5% 450ppm 22E	0.0267	0.0187	0.0163	0.0153	0.0133
R1WCF 33E	resistor carbon film 1W 5% 450ppm 33E	0.0267	0.0187	0.0163	0.0153	0.0133
R1WCF 47E	resistor carbon film 1W 5% 450ppm 47E	0.0267	0.0187	0.0163	0.0153	0.0133
R1WCF 68E	resistor carbon film 1W 5% 450ppm 68E	0.0267	0.0187	0.0163	0.0153	0.0133
R1WCF 100E	resistor carbon film 1W 5% 450ppm 100E	0.0267	0.0187	0.0163	0.0153	0.0133
R1WCF 150E	resistor carbon film 1W 5% 450ppm 150E	0.0267	0.0187	0.0163	0.0153	0.0133
R1WCF 220E	resistor carbon film 1W 5% 450ppm 220E	0.0267	0.0187	0.0163	0.0153	0.0133
R1WCF 330E	resistor carbon film 1W 5% 450ppm 330E	0.0267	0.0187	0.0163	0.0153	0.0133
R1WCF 470E	resistor carbon film 1W 5% 450ppm 470E	0.0267	0.0187	0.0163	0.0153	0.0133
R1WCF 560E	resistor carbon film 1W 5% 450ppm 560E	0.0267	0.0187	0.0163	0.0153	0.0133
R1WCF 680E	resistor carbon film 1W 5% 450ppm 680E	0.0267	0.0187	0.0163	0.0153	0.0133
R1WCF 820E	resistor carbon film 1W 5% 450ppm 820E	0.0267	0.0187	0.0163	0.0153	0.0133
R1WCF 1.0K	resistor carbon film 1W 5% 450ppm 1.0K	0.0267	0.0187	0.0163	0.0153	0.0133
R1WCF 1.5K	resistor carbon film 1W 5% 450ppm 1.5K	0.0267	0.0187	0.0163	0.0153	0.0133
R1WCF 2.2K	resistor carbon film 1W 5% 450ppm 2.2K	0.0267	0.0187	0.0163	0.0153	0.0133
R1WCF 3.0K	resistor carbon film 1W 5% 450ppm 3.0K	0.0267	0.0187	0.0163	0.0153	0.0133
R1WCF 3.3K	resistor carbon film 1W 5% 450ppm 3.3K	0.0267	0.0187	0.0163	0.0153	0.0133
R1WCF 4.7K	resistor carbon film 1W 5% 450ppm 4.7K	0.0267	0.0187	0.0163	0.0153	0.0133
R1WCF 6.8K	resistor carbon film 1W 5% 450ppm 6.8K	0.0267	0.0187	0.0163	0.0153	0.0133
R1WCF 7.5K	resistor carbon film 1W 5% 450ppm 7.5K	0.0267	0.0187	0.0163	0.0153	0.0133
R1WCF 10K	resistor carbon film 1W 5% 450ppm 10K	0.0267	0.0187	0.0163	0.0153	0.0133
R1WCF 12K	resistor carbon film 1W 5% 450ppm 12K	0.0267	0.0187	0.0163	0.0153	0.0133
R1WCF 15K	resistor carbon film 1W 5% 450ppm 15K	0.0267	0.0187	0.0163	0.0153	0.0133
R1WCF 22K	resistor carbon film 1W 5% 450ppm 22K	0.0267	0.0187	0.0163	0.0153	0.0133
R1WCF 33K	resistor carbon film 1W 5% 450ppm 33K	0.0267	0.0187	0.0163	0.0153	0.0133
R1WCF 47K	resistor carbon film 1W 5% 450ppm 47K	0.0267	0.0187	0.0163	0.0153	0.0133
R1WCF 68K	resistor carbon film 1W 5% 450ppm 68K	0.0267	0.0187	0.0163	0.0153	0.0133
R1WCF 100K	resistor carbon film 1W 5% 700ppm 100K	0.0267	0.0187	0.0163	0.0153	0.0133
R1WCF 150K	resistor carbon film 1W 5% 700ppm 150K	0.0267	0.0187	0.0163	0.0153	0.0133
R1WCF 220K	resistor carbon film 1W 5% 700ppm 220K	0.0267	0.0187	0.0163	0.0153	0.0133
R1WCF 330K	resistor carbon film 1W 5% 700ppm 330K	0.0267	0.0187	0.0163	0.0153	0.0133

Resistors

Resistor metal oxide 2W 5%

	1-19	20-99	100-499	500-4999	5000+
R2WMO 0.33E resistor metal oxide 2W 5% 350ppm 0.33E	0.0492	0.0344	0.0300	0.0283	0.0246
R2WMO 0.47E resistor metal oxide 2W 5% 350ppm 0.47E	0.0492	0.0344	0.0300	0.0283	0.0246
R2WMO 0.68E resistor metal oxide 2W 5% 350ppm 0.68E	0.0492	0.0344	0.0300	0.0283	0.0246

Resistor carbon film 2W 5%

R2WCF 1.0E resistor carbon film 2W 5% 300ppm 1.0E	0.0432	0.0302	0.0263	0.0248	0.0216
R2WCF 1.5E resistor carbon film 2W 5% 300ppm 1.5E	0.0432	0.0302	0.0263	0.0248	0.0216
R2WCF 2.2E resistor carbon film 2W 5% 300ppm 2.2E	0.0432	0.0302	0.0263	0.0248	0.0216
R2WCF 3.3E resistor carbon film 2W 5% 300ppm 3.3E	0.0432	0.0302	0.0263	0.0248	0.0216
R2WCF 4.7E resistor carbon film 2W 5% 300ppm 4.7E	0.0432	0.0302	0.0263	0.0248	0.0216
R2WCF 6.8E resistor carbon film 2W 5% 300ppm 6.8E	0.0432	0.0302	0.0263	0.0248	0.0216
R2WCF 10E resistor carbon film 2W 5% 300ppm 10E	0.0432	0.0302	0.0263	0.0248	0.0216
R2WCF 15E resistor carbon film 2W 5% 450ppm 15E	0.0432	0.0302	0.0263	0.0248	0.0216
R2WCF 22E resistor carbon film 2W 5% 450ppm 22E	0.0432	0.0302	0.0263	0.0248	0.0216
R2WCF 33E resistor carbon film 2W 5% 450ppm 33E	0.0432	0.0302	0.0263	0.0248	0.0216
R2WCF 47E resistor carbon film 2W 5% 450ppm 47E	0.0432	0.0302	0.0263	0.0248	0.0216
R2WCF 68E resistor carbon film 2W 5% 450ppm 68E	0.0432	0.0302	0.0263	0.0248	0.0216
R2WCF 100E resistor carbon film 2W 5% 450ppm 100E	0.0432	0.0302	0.0263	0.0248	0.0216
R2WCF 150E resistor carbon film 2W 5% 450ppm 150E	0.0432	0.0302	0.0263	0.0248	0.0216
R2WCF 220E resistor carbon film 2W 5% 450ppm 220E	0.0432	0.0302	0.0263	0.0248	0.0216
R2WCF 330E resistor carbon film 2W 5% 450ppm 330E	0.0432	0.0302	0.0263	0.0248	0.0216
R2WCF 470E resistor carbon film 2W 5% 450ppm 470E	0.0432	0.0302	0.0263	0.0248	0.0216
R2WCF 680E resistor carbon film 2W 5% 450ppm 680E	0.0432	0.0302	0.0263	0.0248	0.0216
R2WCF 1.0K resistor carbon film 2W 5% 450ppm 1.0K	0.0432	0.0302	0.0263	0.0248	0.0216
R2WCF 1.5K resistor carbon film 2W 5% 450ppm 1.5K	0.0432	0.0302	0.0263	0.0248	0.0216
R2WCF 2.2K resistor carbon film 2W 5% 450ppm 2.2K	0.0432	0.0302	0.0263	0.0248	0.0216
R2WCF 3.3K resistor carbon film 2W 5% 450ppm 3.3K	0.0432	0.0302	0.0263	0.0248	0.0216
R2WCF 4.7K resistor carbon film 2W 5% 450ppm 4.7K	0.0432	0.0302	0.0263	0.0248	0.0216
R2WCF 6.8K resistor carbon film 2W 5% 450ppm 6.8K	0.0432	0.0302	0.0263	0.0248	0.0216
R2WCF 10K resistor carbon film 2W 5% 450ppm 10K	0.0432	0.0302	0.0263	0.0248	0.0216
R2WCF 15K resistor carbon film 2W 5% 450ppm 15K	0.0432	0.0302	0.0263	0.0248	0.0216
R2WCF 22K resistor carbon film 2W 5% 450ppm 22K	0.0432	0.0302	0.0263	0.0248	0.0216
R2WCF 33K resistor carbon film 2W 5% 450ppm 33K	0.0432	0.0302	0.0263	0.0248	0.0216
R2WCF 47K resistor carbon film 2W 5% 450ppm 47K	0.0432	0.0302	0.0263	0.0248	0.0216
R2WCF 68K resistor carbon film 2W 5% 450ppm 68K	0.0432	0.0302	0.0263	0.0248	0.0216
R2WCF 100K resistor carbon film 2W 5% 700ppm 100K	0.0432	0.0302	0.0263	0.0248	0.0216

Resistor cement wire wound type 5W 5%

	1-4	5-24	25-99	100-499	500+
R5WCEM 0.10E resistor cement wire wound 5W 5% 0.10E	0.1056	0.0803	0.0777	0.0725	0.0648
R5WCEM 0.12E resistor cement wire wound 5W 5% 0.12E	0.1056	0.0803	0.0777	0.0725	0.0648
R5WCEM 0.15E resistor cement wire wound 5W 5% 0.15E	0.1056	0.0803	0.0777	0.0725	0.0648
R5WCEM 0.18E resistor cement wire wound 5W 5% 0.18E	0.1056	0.0803	0.0777	0.0725	0.0648
R5WCEM 0.22E resistor cement wire wound 5W 5% 0.22E	0.1056	0.0803	0.0777	0.0725	0.0648
R5WCEM 0.27E resistor cement wire wound 5W 5% 0.27E	0.1056	0.0803	0.0777	0.0725	0.0648
R5WCEM 0.33E resistor cement wire wound 5W 5% 0.33E	0.1056	0.0803	0.0777	0.0725	0.0648
R5WCEM 0.39E resistor cement wire wound 5W 5% 0.39E	0.1056	0.0803	0.0777	0.0725	0.0648
R5WCEM 0.47E resistor cement wire wound 5W 5% 0.47E	0.1056	0.0803	0.0777	0.0725	0.0648
R5WCEM 0.56E resistor cement wire wound 5W 5% 0.56E	0.1056	0.0803	0.0777	0.0725	0.0648
R5WCEM 0.68E resistor cement wire wound 5W 5% 0.68E	0.1056	0.0803	0.0777	0.0725	0.0648
R5WCEM 0.82E resistor cement wire wound 5W 5% 0.82E	0.1056	0.0803	0.0777	0.0725	0.0648
R5WCEM 1.0E resistor cement wire wound 5W 5% 1.0E	0.1056	0.0803	0.0777	0.0725	0.0648
R5WCEM 1.2E resistor cement wire wound 5W 5% 1.2E	0.1056	0.0803	0.0777	0.0725	0.0648
R5WCEM 1.5E resistor cement wire wound 5W 5% 1.5E	0.1056	0.0803	0.0777	0.0725	0.0648
R5WCEM 1.8E resistor cement wire wound 5W 5% 1.8E	0.1056	0.0803	0.0777	0.0725	0.0648
R5WCEM 2.0E resistor cement wire wound 5W 5% 2.0E	0.1056	0.0803	0.0777	0.0725	0.0648
R5WCEM 2.2E resistor cement wire wound 5W 5% 2.2E	0.1056	0.0803	0.0777	0.0725	0.0648
R5WCEM 2.7E resistor cement wire wound 5W 5% 2.7E	0.1056	0.0803	0.0777	0.0725	0.0648
R5WCEM 3.3E resistor cement wire wound 5W 5% 3.3E	0.1056	0.0803	0.0777	0.0725	0.0648
R5WCEM 3.9E resistor cement wire wound 5W 5% 3.9E	0.1056	0.0803	0.0777	0.0725	0.0648
R5WCEM 4.7E resistor cement wire wound 5W 5% 4.7E	0.1056	0.0803	0.0777	0.0725	0.0648
R5WCEM 5.6E resistor cement wire wound 5W 5% 5.6E	0.1056	0.0803	0.0777	0.0725	0.0648
R5WCEM 6.8E resistor cement wire wound 5W 5% 6.8E	0.1056	0.0803	0.0777	0.0725	0.0648
R5WCEM 8.2E resistor cement wire wound 5W 5% 8.2E	0.1056	0.0803	0.0777	0.0725	0.0648
R5WCEM 10E resistor cement wire wound 5W 5% 10E	0.1056	0.0803	0.0777	0.0725	0.0648
R5WCEM 12E resistor cement wire wound 5W 5% 12E	0.1056	0.0803	0.0777	0.0725	0.0648
R5WCEM 15E resistor cement wire wound 5W 5% 15E	0.1056	0.0803	0.0777	0.0725	0.0648
R5WCEM 18E resistor cement wire wound 5W 5% 18E	0.1056	0.0803	0.0777	0.0725	0.0648

Резисторы		1-4	5-24	25-99	100-499	500+
Resistor cement wire wound type 10W 5%						
R10WCEM 1.0K	resistor cement layered type 10W 5% 1.0K	0.2364	0.1798	0.1740	0.1624	0.1450
R10WCEM 1.5K	resistor cement layered type 10W 5% 1.5K	0.2364	0.1798	0.1740	0.1624	0.1450
R10WCEM 2.2K	resistor cement layered type 10W 5% 2.2K	0.2364	0.1798	0.1740	0.1624	0.1450
R10WCEM 3.3K	resistor cement layered type 10W 5% 3.3K	0.2364	0.1798	0.1740	0.1624	0.1450
R10WCEM 4.7K	resistor cement layered type 10W 5% 4.7K	0.2364	0.1798	0.1740	0.1624	0.1450
R10WCEM 6.8K	resistor cement layered type 10W 5% 6.8K	0.2364	0.1798	0.1740	0.1624	0.1450
R10WCEM 10K	resistor cement layered type 10W 5% 10K	0.2364	0.1798	0.1740	0.1624	0.1450
R40W 22E	resistor wire wound 40W 5% 22E	4.6820	4.1950	4.0450	3.7460	
R40W 47E	resistor wire wound 40W 5% 47E	4.6820	4.1950	4.0450	3.7460	
R100W 1K	resistor wire wound 100W 5% 1K	9.9230	8.8910	8.5730	7.9380	
Resistor Networks						
		1-9	10-99	100-499	500+	2000+
RA8A9 100R	8 resistors with 9 terminals (SIP) 100 Ohm	0.058	0.051	0.049	0.046	0.041
RA8A9 220R	8 resistors with 9 terminals (SIP) 220 Ohm	0.058	0.051	0.049	0.046	0.041
RA8A9 330R	8 resistors with 9 terminals (SIP) 330 Ohm	0.058	0.051	0.049	0.046	0.041
RA8A9 470R	8 resistors with 9 terminals (SIP) 470 Ohm	0.058	0.051	0.049	0.046	0.041
RA8A9 680R	8 resistors with 9 terminals (SIP) 680 Ohm	0.058	0.051	0.049	0.046	0.041
RA8A9 1.0K	8 resistors with 9 terminals (SIP) 1K	0.058	0.051	0.049	0.046	0.041
RA8A9 2.2K	8 resistors with 9 terminals (SIP) 2.2K	0.058	0.051	0.049	0.046	0.041
RA8A9 3.3K	8 resistors with 9 terminals (SIP) 3.3K	0.058	0.051	0.049	0.046	0.041
RA8A9 4.7K	8 resistors with 9 terminals (SIP) 4.7K	0.058	0.051	0.049	0.046	0.041
RA8A9 10K	8 resistors with 9 terminals (SIP) 10K	0.058	0.051	0.049	0.046	0.041
RA8A9 22K	8 resistors with 9 terminals (SIP) 22K	0.058	0.051	0.049	0.046	0.041
RA8B8 330	8 resistors with 8 terminals (SIP) 330 Ohm	0.097	0.086	0.084	0.078	0.070
RA8B8 470	8 resistors with 8 terminals (SIP) 470 Ohm	0.097	0.086	0.084	0.078	0.070
RA8B8 1K	8 resistors with 8 terminals (SIP) 1K	0.097	0.086	0.084	0.078	0.070
RA8B8 2.2K	4 resistors with 8 terminals (SIP) 2.2K	0.075	0.066	0.064	0.060	0.054
RA8B8 4.7K	8 resistors with 8 terminals (SIP) 4.7K	0.097	0.086	0.084	0.078	0.070
RA8B8 10K	8 resistors with 8 terminals (SIP) 10K	0.097	0.086	0.084	0.078	0.070
R- Trimmers						
		1-9	10-99	100-499	500+	
PT6h(625MC)100R	100mW 6mm	0.109	0.090	0.085	0.075	
PT6h(625MC)500R		0.109	0.090	0.085	0.075	
PT6h(625MC)1K		0.099	0.082	0.077	0.068	
PT6h(625MC)5K		0.099	0.082	0.077	0.068	
PT6h(625MC)10K		0.099	0.082	0.077	0.068	
PT6h(625MC)20K		0.099	0.082	0.077	0.068	
PT6h(625MC)50K		0.099	0.082	0.077	0.068	
PT6h(625MC)100K		0.099	0.082	0.077	0.068	
PT6h(625MC)500K		0.099	0.082	0.077	0.068	
PT6h(625MC)1M		0.099	0.082	0.077	0.068	
PT6v(A)100R		0.203	0.169	0.158	0.140	
PT6v(655MCL)500R		0.099	0.082	0.077	0.068	
PT6v(655MCL)1K		0.099	0.082	0.077	0.068	
PT6v(655MCL)5K		0.099	0.082	0.077	0.068	
PT6v(655MCL)10K		0.099	0.082	0.077	0.068	
PT6v(655MCL)20K		0.099	0.082	0.077	0.068	
PT6v(655MCL)50K		0.099	0.082	0.077	0.068	
PT6v(655MCL)100K		0.099	0.082	0.077	0.068	
PT6v(655MCL)500K		0.099	0.082	0.077	0.068	
BOURNS 3323 10K		0.493	0.440	0.420	0.382	
BOURNS 3323 1K	0.5W 1/4" 6.35mm square	0.492	0.438	0.419	0.381	
BOURNS 3323 5K		0.493	0.440	0.420	0.382	
BOURNS 3006P 10K	0.75W 100ppm/C 19x4.8mm 15turns	0.434	0.366	0.341	0.310	
BOURNS 3006P 1K	0.75W 100ppm/C 19x4.8mm 15turns	0.433	0.365	0.341	0.310	
BOURNS 3006P 50K	0.75W 100ppm/C 19x4.8mm 15turns	0.434	0.366	0.341	0.310	
BOURNS 3006P 5K	0.75W 100ppm/C 19x4.8mm 15turns	0.438	0.369	0.344	0.313	
BOURNS 3296X 100R	0.5W 100ppm/C 9.5x4.8mm 25turns	0.641	0.541	0.504	0.458	
BOURNS 3296X 100K	0.5W 100ppm/C 9.5x4.8mm 25turns	0.641	0.541	0.504	0.458	
BOURNS 3296X 10K	0.5W 100ppm/C 9.5x4.8mm 25turns	0.640	0.539	0.503	0.457	
BOURNS 3296X 1K	0.5W 100ppm/C 9.5x4.8mm 25turns	0.640	0.539	0.503	0.457	
BOURNS 3296X 200R	0.5W 100ppm/C 9.5x4.8mm 25turns	0.713	0.601	0.560	0.509	
BOURNS 3296X 200K	0.5W 100ppm/C 9.5x4.8mm 25turns	0.713	0.601	0.560	0.509	
BOURNS 3296X 20K	0.5W 100ppm/C 9.5x4.8mm 25turns	0.641	0.541	0.504	0.458	



PT6h



PT6v

R-Trimmers		1-9	10-99	100-499	500+
BOURNS 3296X 2K	0.5W 100ppm/C 9.5x4.8mm 25turns	0.641	0.541	0.504	0.458
BOURNS 3296X 500R	0.5W 100ppm/C 9.5x4.8mm 25turns	0.641	0.541	0.504	0.458
BOURNS 3296X 500K	0.5W 100ppm/C 9.5x4.8mm 25turns	0.713	0.601	0.560	0.509
BOURNS 3296X 50K	0.5W 100ppm/C 9.5x4.8mm 25turns	0.641	0.541	0.504	0.458
BOURNS 3296X 5K	0.5W 100ppm/C 9.5x4.8mm 25turns	0.641	0.541	0.504	0.458
BOURNS 3296W 100R	0.5W 100ppm/C 9.5x4.8mm 25turns	0.641	0.541	0.504	0.458
BOURNS 3296W 100K	0.5W 100ppm/C 9.5x4.8mm 25turns	0.641	0.541	0.504	0.458
BOURNS 3296W 10K	0.5W 100ppm/C 9.5x4.8mm 25turns	0.641	0.541	0.504	0.458
BOURNS 3296W 1K	0.5W 100ppm/C 9.5x4.8mm 25turns	0.643	0.542	0.505	0.459
BOURNS 3296W 1M	0.5W 100ppm/C 9.5x4.8mm 25turns	0.641	0.541	0.504	0.458
BOURNS 3296W 200R	0.5W 100ppm/C 9.5x4.8mm 25turns	0.652	0.549	0.512	0.466
BOURNS 3296W 200K	0.5W 100ppm/C 9.5x4.8mm 25turns	0.641	0.541	0.504	0.458
BOURNS 3296W 20K	0.5W 100ppm/C 9.5x4.8mm 25turns	0.641	0.541	0.504	0.458
BOURNS 3296W 2K	0.5W 100ppm/C 9.5x4.8mm 25turns	0.641	0.541	0.504	0.458
BOURNS 3296W 500R	0.5W 100ppm/C 9.5x4.8mm 25turns	0.641	0.541	0.504	0.458
BOURNS 3296W 500K	0.5W 100ppm/C 9.5x4.8mm 25turns	0.634	0.534	0.498	0.453
BOURNS 3296W 50K	0.5W 100ppm/C 9.5x4.8mm 25turns	0.641	0.541	0.504	0.458
BOURNS 3296W 5K	0.5W 100ppm/C 9.5x4.8mm 25turns	0.634	0.534	0.498	0.453
BOURNS 3299 500R					
PT6KH 2.5K	0.15W ϕ 10mm PIHER	0.177	0.157	0.140	0.131
PT10LH 1K	0.15W ϕ 10mm PIHER	0.177	0.157	0.140	0.131
PT10LH 10K	0.15W ϕ 10mm PIHER	0.177	0.157	0.140	0.131
PT10LH 100K	0.15W ϕ 10mm PIHER	0.177	0.157	0.140	0.131
PT10LH 5K	0.15W ϕ 10mm PIHER	0.177	0.157	0.140	0.131
PT10LH 50K	0.15W ϕ 10mm PIHER	0.177	0.157	0.140	0.131
PT10LV 1K	0.15W ϕ 10mm PIHER	0.177	0.157	0.140	0.131
PT10LV 10K	0.15W ϕ 10mm PIHER	0.177	0.157	0.140	0.131
PT10LV 100K	0.15W ϕ 10mm PIHER	0.177	0.157	0.140	0.131
PT10LV 250K	0.15W ϕ 10mm PIHER	0.177	0.157	0.140	0.131
PT10LV 5K	0.15W ϕ 10mm PIHER	0.177	0.157	0.140	0.131
PT10LV 50K	0.15W ϕ 10mm PIHER	0.177	0.157	0.140	0.131
PT15LH 1K	0.25W ϕ 15mm PIHER	0.203	0.181	0.161	0.151
PT15LH 5K	0.25W ϕ 15mm PIHER	0.203	0.181	0.161	0.151
PT15LH 10K	0.25W ϕ 15mm PIHER	0.203	0.181	0.161	0.151
PT15LH 50K	0.25W ϕ 15mm PIHER	0.203	0.181	0.161	0.151
PT15LH 100K	0.25W ϕ 15mm PIHER	0.203	0.181	0.161	0.151
PT15LH 2.2M	0.25W ϕ 15mm PIHER	0.203	0.181	0.161	0.151
PT15LV 1K	0.25W ϕ 15mm PIHER	0.203	0.181	0.161	0.151
PT15LV 5K	0.25W ϕ 15mm PIHER	0.203	0.181	0.161	0.151
PT15LV 10K	0.25W ϕ 15mm PIHER	0.203	0.181	0.161	0.151
PT15LV 25K	0.25W ϕ 15mm PIHER	0.203	0.181	0.161	0.151
PT15LV 50K	0.25W ϕ 15mm PIHER	0.203	0.181	0.161	0.151
PT15NV 1K	0.25W ϕ 15mm PIHER	0.203	0.181	0.161	0.151
PT15NV 5K	0.25W ϕ 15mm PIHER	0.203	0.181	0.161	0.151
PT15NV 10K	0.25W ϕ 15mm PIHER	0.203	0.181	0.161	0.151
PT15NV 25K	0.25W ϕ 15mm PIHER	0.203	0.181	0.161	0.151
TRV625MC 1K	trimmer vert.6mm 1K	0.118	0.105	0.096	0.087
TRV625MC 5K	trimmer vert.6mm 4.7K	0.118	0.105	0.096	0.087
TRV625MC 10K	trimmer vert.6mm 10K	0.118	0.105	0.096	0.087
TRV625MC 20K	trimmer vert.6mm 22K	0.171	0.152	0.140	0.127
TRV625MC 50K	trimmer vert.6mm 47K	0.118	0.105	0.096	0.087
TRV625MC 100K	trimmer vert.6mm 100K	0.118	0.105	0.096	0.087
TRV625MC 200K	trimmer vert.6mm 220K	0.171	0.152	0.140	0.127
TRH655MCL 1K	trimmer horiz.6mm 1K	0.118	0.105	0.096	0.087
TRH655MCL 5K	trimmer horiz.6mm 5K	0.118	0.105	0.096	0.087
TRH655MCL 10K	trimmer horiz.6mm 10K	0.118	0.105	0.096	0.087
TRH655MCL 20K	trimmer horiz.6mm 20K	0.171	0.152	0.140	0.127
TRH655MCL 50K	trimmer horiz.6mm 50K	0.118	0.105	0.096	0.087
TRH655MCL 100K	trimmer horiz.6mm 100K	0.118	0.105	0.096	0.087
TRH655MCL 200K	trimmer horiz.6mm 200K	0.171	0.152	0.140	0.127
TRH115 4K7	shaft rotary trimmer 4.7K	0.279	0.248	0.228	0.207
TRH115 10K	shaft rotary trimmer 10K	0.279	0.248	0.228	0.207
TRMVR 4K7 SMD ROHM	SMD trimmer 4.7K	0.107	0.095	0.087	0.079
TRMVR 10K SMD ROHM	SMD trimmer 10K	0.107	0.095	0.087	0.079
TRMVR 100K SMD ROHM	SMD trimmer 100K	0.107	0.095	0.087	0.079



PT10LH



PT10LV



PT15LH



PT15LV



PT15NV

Potentiometers

		1-9	10-99	100-499	500+
POT16K1-LIN1K	potentiometer 1K	0.395	0.329	0.308	0.272
POT16K1-LIN5K	potentiometer 5K	0.395	0.329	0.308	0.272
POT16K1-LIN10K	potentiometer 10K	0.400	0.333	0.312	0.276
POT16K1-LIN50K	potentiometer 50K	0.395	0.329	0.308	0.272
POT16K1-LIN100K	potentiometer 100K	0.395	0.329	0.308	0.272
POT16K1-LIN500K	potentiometer 500K	0.428	0.356	0.333	0.295
POTSW16KN1-LIN10K	potentiometer 10K	0.568	0.473	0.443	0.392
POT16T1-LIN2x10K	dual pot. horizontal 10K 20% linear	0.589	0.509	0.476	0.421
POT16T1-LIN2x22K	dual pot. horizontal 22K 20% linear	0.589	0.509	0.476	0.421
POT16T1-LIN2x47K	dual pot. horizontal 47K 20% linear	0.589	0.509	0.476	0.421
POT16T1-LIN2x100K	dual pot. horizontal 100K 20% linear	0.589	0.509	0.476	0.421
POT16T1-LOG2x10K	dual pot. horizontal 10K 20% log	0.605	0.523	0.488	0.432
POT16T1-LOG2x22K	dual pot. horizontal 22K 20% log	0.605	0.523	0.488	0.432
POT16T1-LOG2x47K	dual pot. horizontal 47K 20% log	0.605	0.523	0.488	0.432
POT16T1-LOG2x100K	dual pot. horizontal 100K 20% log	0.605	0.523	0.488	0.432
POT16T1-ALOG2x250K	dual pot. horizontal 250K 20% alog	0.858	0.741	0.692	0.613
POT16T3-R-LIN2x10K	dual pot. vertical 10K 20% linear	0.599	0.518	0.483	0.428
POT16T3-R-LIN2x22K	dual pot. vertical 22K 20% linear	0.599	0.518	0.483	0.428
POT16T3-R-LIN2x47K	dual pot. vertical 47K 20% linear	0.599	0.518	0.483	0.428
POT16T3-R-LIN2x100K	dual pot. vertical 100K 20% linear	0.599	0.518	0.483	0.428
POTSL60V3-LIN10K	Slide potentiometer 10K 20% linear	0.623	0.538	0.503	0.445
POTSL60V3-LIN47K	Slide potentiometer 47K 20% linear	0.623	0.538	0.503	0.445
POTSL60V3-LIN100K	Slide potentiometer 10K 20% linear	0.623	0.538	0.503	0.445
POTSL60V3-LOG10K	Slide potentiometer 10K 20% log	0.623	0.538	0.503	0.445
POTSL60V3-LOG47K	Slide potentiometer 47K 20% log	0.623	0.538	0.503	0.445
POTSL60V3-LOG100K	Slide potentiometer 10K 20% log	0.623	0.538	0.503	0.445
		1-4	5-24	25-99	100+
POTRK2122G-LIN2x20K	snap-in potentiometer 20K 20% linear	4.539	4.067	3.922	3.632
POTRK2122G-LIN2x50K	snap-in potentiometer 50K 20% linear	4.539	4.067	3.922	3.632
POTRK2122G-LIN2x100K	snap-in potentiometer 100K 20% linear	4.539	4.067	3.922	3.632
POTRK2122G-LOG2x22K	snap-in potentiometer 22K 20% log	4.539	4.067	3.922	3.632
POTRK2122G-LOG2x47K	snap-in potentiometer 47K 20% log	4.539	4.067	3.922	3.632
POTRK2122G-LOG2x10K	snap-in potentiometer 10K 20% log	4.539	4.067	3.922	3.632

Trimmer Capacitors

		1-9	10-99	100-499	500+
CVN605 5pF	trimmer-cap. 2 - 5pF Q>500(1MHz)	0.101	0.084	0.078	0.069
CVN610 10pF	trimmer-cap. 3 - 10pF Q>500(1MHz)	0.103	0.086	0.081	0.071
CVN630 30pF	trimmer-cap. 6.2 - 30pF Q>500(1MHz)	0.106	0.088	0.082	0.073
CVN650 50pF	trimmer-cap. 9.8 - 50pF Q>300(1MHz)	0.113	0.094	0.088	0.078



CVN605

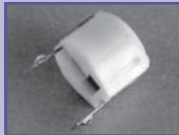

CVN610



CVN630



CVN650

Tantalum Capacitors

	1-9	10-99	100-499	500-1999	2000+
TANT 1uF 35V	0.101	0.091	0.084	0.078	0.072
TANT 2.2uF 16V	0.084	0.075	0.069	0.064	0.060
TANT 3.3uF 15V	0.116	0.104	0.096	0.089	0.083
TANT 4.7uF 16V	0.108	0.097	0.089	0.083	0.077
TANT 10uF 16V	0.125	0.112	0.103	0.096	0.089
TANT 15uF 20V	0.153	0.138	0.127	0.118	0.109
TANT 22uF 16V	0.286	0.267	0.248	0.230	0.215
TANT 33uF 10V	0.159	0.148	0.137	0.128	0.119
TANT 47uF 16V	0.594	0.554	0.514	0.478	0.447

Capacitors MPT111

	1-9	10-99	100-499	500+	2000+
1nF 100V	0.032	0.029	0.027	0.025	0.023
1.5nF 100V	0.032	0.029	0.027	0.025	0.023
2.2nF 100V	0.032	0.029	0.027	0.025	0.023
4.7nF 100V	0.032	0.029	0.026	0.024	0.023

Capacitors MPT111			1-9	10-99	100-499	500+	2000+
10nF 100V			0.034	0.030	0.028	0.026	0.024
22nF 63V			0.032	0.029	0.027	0.025	0.023
22nF 100V			0.034	0.030	0.028	0.026	0.024
33nF 63V			0.032	0.029	0.027	0.025	0.023
33nF 100V			0.035	0.032	0.029	0.027	0.025
47nF 63V			0.030	0.027	0.025	0.023	0.021
47nF 100V			0.035	0.032	0.029	0.027	0.025
68nF 63V			0.036	0.032	0.029	0.027	0.025
68nF 100V			0.037	0.033	0.030	0.028	0.026
100nF 63V			0.034	0.030	0.028	0.026	0.024
100nF 100V			0.056	0.050	0.046	0.043	0.040
150nF 63V			0.068	0.061	0.056	0.052	0.048
330nF 63V			0.097	0.087	0.080	0.075	0.069
470nF 63V			0.110	0.099	0.091	0.085	0.079
Capacitors MPT221			1-9	10-99	100-499	500+	2000+
4.7nF 400V 10%			0.038	0.034	0.032	0.029	0.027
10nF 63V 10%			0.041	0.037	0.034	0.032	0.029
47nF 250V 20%			0.037	0.033	0.030	0.028	0.026
47nF 630V 10%			0.059	0.053	0.049	0.045	0.042
100nF 250V 10%			0.040	0.036	0.033	0.031	0.029
100nF 250V 20%			0.038	0.034	0.031	0.029	0.027
100nF 400V 10%			0.055	0.050	0.046	0.043	0.039
100nF 400V 20%			0.054	0.048	0.044	0.041	0.038
220nF 160V 10%			0.060	0.054	0.050	0.047	0.043
220nF 250V 20%			0.057	0.051	0.047	0.044	0.041
220nF 400V 10%			0.092	0.083	0.076	0.071	0.066
220nF 400V 20%			0.102	0.092	0.085	0.079	0.073
470nF 250V 10%			0.119	0.107	0.098	0.092	0.085
470nF 250V 20%			0.091	0.082	0.075	0.070	0.065
470nF 400V 10%			0.150	0.135	0.125	0.116	0.107
470nF 400V 20%			0.123	0.111	0.102	0.095	0.088
1uF 160V 10%			0.150	0.135	0.125	0.116	0.107
1uF 250V 10%			0.176	0.158	0.145	0.135	0.125
1uF 250V 20%			0.136	0.123	0.113	0.105	0.097
1uF 400V 10%			0.265	0.238	0.220	0.204	0.189
1.5uF 250V 10%			0.150	0.135	0.124	0.116	0.107
2.2uF 250V 20%			0.239	0.215	0.198	0.184	0.171
Capacitors WIMA			1-9	10-99	100-499	500+	2000+
1.5nF 1000V 5% MKP10		Polypropylene Cap. 4x9x13 RM10	0.113	0.102	0.094	0.087	0.081
3.3nF 1000V 5% MKP10		Polypropylene Cap. 4x9x13 RM10	0.131	0.118	0.109	0.101	0.094
10nF 400V 10% MKP10		Polypropylene Cap. 4x9x10 RM7.5	0.102	0.092	0.085	0.079	0.073
10nF 1000V 10% MKP10		Polypropylene Cap. 5x11x13 RM10	0.152	0.137	0.126	0.117	0.109
22nF 400V 10% MKP10		Polypropylene Cap. 4x9.5x13 RM10	0.155	0.139	0.128	0.119	0.110
47nF 400V 10% MKP10		Polypropylene Cap. 5x11x18 RM15	0.187	0.168	0.155	0.144	0.133
100nF 400V 10% MKP10		Polypropylene Cap. 7x14x18 RM15	0.207	0.186	0.172	0.160	0.148
220nF 400V 10% MKP10		Polypropylene Cap. 7x16.5x26.5 RM22.5	0.376	0.338	0.311	0.290	0.268
470nF 400V 10% MKP10		Polypropylene Cap. 10.5x19x26.5 RM22.5	0.490	0.441	0.406	0.378	0.350
1.0uF 400V 10% MKP10		Polypropylene Cap. 13x24x31.5 RM27.5	1.046	0.942	0.867	0.807	0.747
1.0nF 400V 10% FKS2		Polyester Cap. 2.5x6.5x7.2 RM5	0.048	0.043	0.040	0.037	0.034
1.5nF 400V 10% FKS2		Polyester Cap. 2.5x6.5x7.2 RM5	0.048	0.043	0.040	0.037	0.034
2.2nF 400V 10% FKS2		Polyester Cap. 2.5x6.5x7.2 RM5	0.048	0.043	0.040	0.037	0.034
3.3nF 400V 10% FKS2		Polyester Cap. 2.5x6.5x7.2 RM5	0.048	0.043	0.040	0.037	0.034
4.7nF 400V 10% FKS2		Polyester Cap. 2.5x6.5x7.2 RM5	0.048	0.043	0.040	0.037	0.034
6.8nF 400V 10% FKS2		Polyester Cap. 3x7.5x7.2 RM5	0.056	0.051	0.047	0.044	0.040
10nF 250V 10% FKS2		Polyester Cap. 3x7.5x7.2 RM5	0.052	0.047	0.043	0.040	0.037
10nF 400V 10% FKS2		Polyester Cap. 3.5x8.5x7.2 RM5	0.069	0.063	0.058	0.054	0.050
15nF 250V 10% MKS2		Polyester Cap. 2.5x6.5x7.2 RM5	0.058	0.052	0.048	0.045	0.042
15nF 400V 10% MKS4		Polyester Cap. 4x9x10 RM7.5	0.078	0.070	0.064	0.060	0.056
22nF 250V 10% MKS2		Polyester Cap. 3x7.5x7.2 RM5	0.066	0.059	0.055	0.051	0.047
22nF 400V 10% MKS4		Polyester Cap. 4.5x9.5x10.3 RM7.5	0.085	0.077	0.071	0.066	0.061
33nF 250V 10% MKS2		Polyester Cap. 3.5x8.5x7.2 RM5	0.071	0.064	0.059	0.055	0.051
33nF 400V 10% MKS4		Polyester Cap. 5x10.5x10.3 RM7.5	0.086	0.078	0.072	0.067	0.062
47nF 250V 10% MKS2		Polyester Cap. 4.5x9.5x7.2 RM5	0.075	0.067	0.062	0.058	0.053
47nF 400V 10% MKS4		Polyester Cap. 5.7x12.5x10.3 RM7.5	0.096	0.087	0.080	0.074	0.069

Capacitors WIMA			1-9	10-99	100-499	500+	2000+
68nF 250V 10% MKS2	Polyester Cap. 5x10x7.2 RM5		0.081	0.073	0.067	0.062	0.058
68nF 400V 10% MKS4	Polyester Cap. 5x11x13 RM10		0.106	0.096	0.088	0.082	0.076
100nF 63V 10% MKS02	Polyester Cap. 3x7.5x4.6 RM2.5		0.117	0.105	0.097	0.090	0.083
100nF 250V 10% MKS2	Polyester Cap. 5.5x11.5x7.2 RM5		0.096	0.086	0.079	0.074	0.068
100nF 400V 10% MKS4	Polyester Cap. 6x12.5x13 RM10		0.116	0.105	0.096	0.090	0.083
150nF 250V 10% MKS4	Polyester Cap. 5x10.5x10.3 RM7.5		0.100	0.090	0.083	0.077	0.071
150nF 400V 10% MKS4	Polyester Cap. 6x12.5x18 RM15		0.162	0.145	0.134	0.125	0.115
220nF 250V 10% MKS4	Polyester Cap. 5x10.5x10.3 RM7.5		0.114	0.102	0.094	0.088	0.081
220nF 400V 10% MKS4	Polyester Cap. 7x14x18 RM15		0.212	0.190	0.175	0.163	0.151
330nF 250V 10% MKS4	Polyester Cap. 5.7x12.5x10.3 RM7.5		0.135	0.121	0.112	0.104	0.096
330nF 400V 10% MKS4	Polyester Cap. 8x15x18 RM15		0.245	0.220	0.203	0.189	0.175
470nF 100V 10% MKS4	Polyester Cap. 5x10.5x10.3 RM7.5		0.141	0.127	0.117	0.109	0.101
470nF 250V 10% MKS4	Polyester Cap. 6x12.5x18 RM15		0.186	0.167	0.154	0.144	0.133
470nF 400V 10% MKS4	Polyester Cap. 7x16.5x26.5 RM22.5		0.313	0.281	0.259	0.241	0.223
680nF 250V 10% MKS4	Polyester Cap. 7x14x18 RM15		0.243	0.219	0.201	0.187	0.173
680nF 400V 10% MKS4	Polyester Cap. 10.5x19x26.5 RM22.5		0.431	0.388	0.357	0.333	0.308
1.0uF 63V 10% MKS2	Polyester Cap. 5x10x7.2 RM5		0.192	0.173	0.159	0.148	0.137
1.0uF 100V 10% MKS4	Polyester Cap. 5.7x12.5x10.3 RM7.5		0.210	0.189	0.174	0.162	0.150
1.0uF 250V 10% MKS4	Polyester Cap. 9x16x18 RM15		0.275	0.247	0.228	0.212	0.196
1.0uF 400V 10% MKS4	Polyester Cap. 11x21x26.5 RM22.5		0.471	0.424	0.390	0.363	0.336
1.5uF 63V 10% MKS4	Polyester Cap. 5x11x13 RM10		0.270	0.243	0.224	0.208	0.193
1.5uF 250V 10% MKS4	Polyester Cap. 7x16.5x26.5 RM22.5		0.414	0.373	0.343	0.319	0.296
2.2uF 100V 10% MKS4	Polyester Cap. 8x15x18 RM15		0.397	0.357	0.329	0.306	0.283
2.2uF 250V 10% MKS4	Polyester Cap. 10.5x19x26.5 RM22.5		0.533	0.480	0.442	0.411	0.381
3.3uF 63V 10% MKS4	Polyester Cap. 7x14x18 RM15		0.516	0.465	0.428	0.398	0.369
4.7uF 63V 10% MKS4	Polyester Cap. 8x15x18 RM15		0.646	0.582	0.536	0.499	0.462
6.8uF 63V 10% MKS4	Polyester Cap. 7x16.5x26.5 RM22.5		0.932	0.839	0.772	0.719	0.666
10uF 63V 10% MKS4	Polyester Cap. 8.5x18.5x26.5 RM22.5		1.377	1.239	1.141	1.062	0.983
MKT 0.22uF 250V			0.137	0.123	0.113	0.106	0.098
MKT 0.33uF 250V			0.182	0.164	0.151	0.141	0.130
MKT 0.47uF 250V			0.185	0.167	0.153	0.143	0.132
MKT 0.47uF 400V			0.259	0.233	0.215	0.200	0.185
MKT 0.68uF 250V			0.287	0.258	0.238	0.221	0.205
MKT 1uF 250V			0.253	0.228	0.210	0.195	0.181
MKT 1uF 400V			0.408	0.367	0.338	0.314	0.291
Electrolytic capacitors			1-9	10-99	100-499	500+	2000+
0.47uF 63V	electrolyt.cap.EA-7 0.47uF 63V 5x11 mm		0.019	0.012	0.011	0.010	0.009
0.47uF 100V	electrolyt.cap.EA-7 0.47uF 100V 5x11 mm		0.019	0.012	0.011	0.010	0.009
1.0uF 10V	electrolyt.cap.EA-7 1.0uF 10V 5x11 mm		0.019	0.012	0.011	0.010	0.009
1.0uF 16V	electrolyt.cap.EA-7 1.0uF 16V 5x11 mm		0.019	0.012	0.011	0.010	0.009
1.0uF 25V	electrolyt.cap.EA-7 1.0uF 25V 5x11 mm		0.019	0.012	0.011	0.010	0.009
1.0uF 35V	electrolyt.cap.EA-7 1.0uF 35V 5x11 mm		0.019	0.012	0.011	0.010	0.009
1.0uF 50V	electrolyt.cap.EA-7 1.0uF 50V 5x11 mm		0.019	0.012	0.011	0.010	0.009
1.0uF 63V	electrolyt.cap.EA-7 1.0uF 63V 5x11 mm		0.019	0.012	0.011	0.010	0.009
1.0uF 100V	electrolyt.cap.EA-7 1.0uF 100V 5x11 mm		0.019	0.012	0.011	0.010	0.009
2.2uF 10V	electrolyt.cap.EA-7 2.2uF 10V 5x11 mm		0.019	0.012	0.011	0.010	0.009
2.2uF 16V	electrolyt.cap.EA-7 2.2uF 16V 5x11 mm		0.019	0.012	0.011	0.010	0.009
2.2uF 25V	electrolyt.cap.EA-7 2.2uF 25V 5x11 mm		0.019	0.012	0.011	0.010	0.009
2.2uF 35V	electrolyt.cap.EA-7 2.2uF 35V 5x11 mm		0.019	0.012	0.011	0.010	0.009
2.2uF 50V	electrolyt.cap.EA-7 2.2uF 50V 5x11 mm		0.019	0.012	0.011	0.010	0.009
2.2uF 63V	electrolyt.cap.EA-7 2.2uF 63V 5x11 mm		0.019	0.012	0.011	0.010	0.009
2.2uF 100V	electrolyt.cap.EA-7 2.2uF 100V 5x11 mm		0.019	0.012	0.011	0.010	0.009
3.3uF 10V	electrolyt.cap.EA-7 3.3uF 10V 5x11 mm		0.019	0.012	0.011	0.010	0.009
3.3uF 16V	electrolyt.cap.EA-7 3.3uF 16V 5x11 mm		0.019	0.012	0.011	0.010	0.009
3.3uF 25V	electrolyt.cap.EA-7 3.3uF 25V 5x11 mm		0.019	0.012	0.011	0.010	0.009
3.3uF 35V	electrolyt.cap.EA-7 3.3uF 35V 5x11 mm		0.019	0.012	0.011	0.010	0.009
3.3uF 50V	electrolyt.cap.EA-7 3.3uF 50V 5x11 mm		0.019	0.012	0.011	0.010	0.009
3.3uF 63V	electrolyt.cap.EA-7 3.3uF 63V 5x11 mm		0.019	0.012	0.011	0.010	0.009
3.3uF 100V	electrolyt.cap.EA-7 3.3uF 100V 5x11 mm		0.019	0.012	0.011	0.010	0.009
4.7uF 16V	electrolyt.cap.EA-7 4.7uF 16V 5x11 mm		0.019	0.012	0.011	0.010	0.009
4.7uF 25V	electrolyt.cap.EA-7 4.7uF 25V 5x11 mm		0.019	0.012	0.011	0.010	0.009
4.7uF 35V	electrolyt.cap.EA-7 4.7uF 35V 5x11 mm		0.019	0.012	0.011	0.010	0.009
4.7uF 50V	electrolyt.cap.EA-7 4.7uF 50V 5x11 mm		0.019	0.012	0.011	0.010	0.009
4.7uF 63V	electrolyt.cap.EA-7 4.7uF 63V 5x11 mm		0.019	0.012	0.011	0.010	0.009

<i>Electrolytic capacitors</i>		1-9	10-99	100-499	500+	2000+
4.7uF 100V	<i>electrolyt.cap.EA-7 4.7uF 100V 5x11 mm</i>	0.022	0.015	0.013	0.012	0.011
10uF 16V	<i>electrolyt.cap.EA-7 10uF 16V 5x11 mm</i>	0.021	0.014	0.012	0.012	0.011
10uF 25V	<i>electrolyt.cap.EA-7 10uF 25V 5x11 mm</i>	0.022	0.014	0.013	0.012	0.011
10uF 35V	<i>electrolyt.cap.EA-7 10uF 35V 5x11 mm</i>	0.022	0.014	0.013	0.012	0.011
10uF 50V	<i>electrolyt.cap.EA-7 10uF 50V 5x11 mm</i>	0.022	0.015	0.013	0.012	0.011
10uF 63V	<i>electrolyt.cap.EA-7 10uF 63V 5x11 mm</i>	0.023	0.015	0.013	0.012	0.011
10uF 100V	<i>electrolyt.cap.EA-7 10uF 100V 6.3x11 mm</i>	0.028	0.020	0.019	0.017	0.016
22uF 10V	<i>electrolyt.cap.EA-7 22uF 10V 5x11 mm</i>	0.023	0.015	0.013	0.012	0.011
22uF 16V	<i>electrolyt.cap.EA-7 22uF 16V 5x11 mm</i>	0.023	0.015	0.013	0.012	0.011
22uF 25V	<i>electrolyt.cap.EA-7 22uF 25V 5x11 mm</i>	0.023	0.015	0.013	0.012	0.011
22uF 35V	<i>electrolyt.cap.EA-7 22uF 35V 5x11 mm</i>	0.024	0.016	0.014	0.013	0.012
22uF 50V	<i>electrolyt.cap.EA-7 22uF 50V 6.3x11 mm</i>	0.024	0.016	0.014	0.013	0.012
22uF 63V	<i>electrolyt.cap.EA-7 22uF 63V 6.3x11 mm</i>	0.028	0.020	0.019	0.017	0.016
22uF 100V	<i>electrolyt.cap.EA-7 22uF 100V 8x11.5 mm</i>	0.037	0.030	0.027	0.025	0.023
33uF 10V	<i>electrolyt.cap.EA-7 33uF 10V 5x11 mm</i>	0.023	0.015	0.014	0.013	0.012
33uF 16V	<i>electrolyt.cap.EA-7 33uF 16V 5x11 mm</i>	0.024	0.016	0.014	0.013	0.012
33uF 25V	<i>electrolyt.cap.EA-7 33uF 25V 5x11 mm</i>	0.024	0.016	0.014	0.013	0.012
33uF 35V	<i>electrolyt.cap.EA-7 33uF 35V 6.3x11 mm</i>	0.025	0.017	0.015	0.014	0.013
33uF 50V	<i>electrolyt.cap.EA-7 33uF 50V 6.3x11 mm</i>	0.028	0.020	0.019	0.017	0.016
33uF 63V	<i>electrolyt.cap.EA-7 33uF 63V 8x11.5 mm</i>	0.039	0.032	0.029	0.027	0.025
33uF 100V	<i>electrolyt.cap.EA-7 33uF 100V 10x16.5 mm</i>	0.068	0.054	0.050	0.046	0.042
47uF 10V	<i>electrolyt.cap.EA-7 47uF 10V 5x11 mm</i>	0.025	0.017	0.015	0.014	0.013
47uF 16V	<i>electrolyt.cap.EA-7 47uF 16V 5x11 mm</i>	0.026	0.017	0.015	0.014	0.013
47uF 25V	<i>electrolyt.cap.EA-7 47uF 25V 6.3x11 mm</i>	0.030	0.019	0.017	0.016	0.015
47uF 35V	<i>electrolyt.cap.EA-7 47uF 35V 6.3x11 mm</i>	0.031	0.022	0.020	0.019	0.017
47uF 50V	<i>electrolyt.cap.EA-7 47uF 50V 8x11.5 mm</i>	0.035	0.025	0.023	0.021	0.020
47uF 63V	<i>electrolyt.cap.EA-7 47uF 63V 8x11.5 mm</i>	0.044	0.035	0.032	0.029	0.027
47uF 63V JAMICON	<i>electrolyt.cap. 47uF 63V 6.3x11 mm JAMICON</i>	0.026	0.021	0.019	0.018	0.016
47uF 100V	<i>electrolyt.cap.EA-7 47uF 100V 10x16.5 mm</i>	0.062	0.056	0.051	0.048	0.044
100uF 6.3V	<i>electrolyt.cap.EA-7 100uF 6.3V 5x11 mm</i>	0.027	0.018	0.016	0.015	0.014
100uF 10V	<i>electrolyt.cap.EA-7 100uF 10V 5x11 mm</i>	0.028	0.018	0.016	0.015	0.014
100uF 16V	<i>electrolyt.cap.EA-7 100uF 16V 6.3x11 mm</i>	0.032	0.021	0.019	0.017	0.016
100uF 25V	<i>electrolyt.cap.EA-7 100uF 25V 8x11.5 mm</i>	0.038	0.026	0.025	0.023	0.021
100uF 35V	<i>electrolyt.cap.EA-7 100uF 35V 8x11.5 mm</i>	0.045	0.036	0.033	0.030	0.028
100uF 50V	<i>electrolyt.cap.EA-7 100uF 50V 8x14 mm</i>	0.050	0.040	0.037	0.034	0.032
100uF 50V JAMICON	<i>electrolyt.cap. 100uF 50V 8x11 mm JAMICON</i>	0.043	0.035	0.032	0.029	0.027
100uF 63V	<i>electrolyt.cap.EA-7 100uF 63V 10x16.5 mm</i>	0.071	0.064	0.059	0.055	0.051
100uF 100V	<i>electrolyt.cap.EA-7 100uF 100V 12.5x20.5 mm</i>	0.125	0.113	0.104	0.097	0.090
220uF 6.3V	<i>electrolyt.cap.EA-7 220uF 6.3V 6.3x11 mm</i>	0.032	0.022	0.020	0.019	0.018
220uF 10V	<i>electrolyt.cap.EA-7 220uF 10V 6.3x11 mm</i>	0.032	0.023	0.021	0.019	0.018
220uF 16V	<i>electrolyt.cap.EA-7 220uF 16V 8x11.5 mm</i>	0.041	0.029	0.027	0.025	0.023
220uF 25V	<i>electrolyt.cap.EA-7 220uF 25V 8x14 mm</i>	0.049	0.039	0.036	0.033	0.031
220uF 35V	<i>electrolyt.cap.EA-7 220uF 35V 10x16.5 mm</i>	0.063	0.050	0.046	0.042	0.039
220uF 35V JAMICON	<i>electrolyt.cap. 220uF 35V 8x11 mm JAMICON</i>	0.043	0.035	0.032	0.029	0.027
220uF 50V	<i>electrolyt.cap.EA-7 220uF 50V 10x20.5 mm</i>	0.093	0.074	0.068	0.063	0.058
220uF 63V	<i>electrolyt.cap.EA-7 220uF 63V 12.5x20.5 mm</i>	0.117	0.105	0.097	0.090	0.083
220uF 100V	<i>electrolyt.cap.EA-7 220uF 100V 16x25 mm</i>	0.026	0.023	0.021	0.020	0.018
330uF 6.3V	<i>electrolyt.cap.EA-7 330uF 6.3V 8x11.5 mm</i>	0.046	0.032	0.030	0.027	0.025
330uF 10V	<i>electrolyt.cap.EA-7 330uF 10V 8x11.5 mm</i>	0.047	0.033	0.031	0.028	0.026
330uF 16V	<i>electrolyt.cap.EA-7 330uF 16V 8x14 mm</i>	0.053	0.037	0.035	0.032	0.030
330uF 25V	<i>electrolyt.cap.EA-7 330uF 25V 10x16.5 mm</i>	0.060	0.048	0.044	0.040	0.037
330uF 35V	<i>electrolyt.cap.EA-7 330uF 35V 10x20.5 mm</i>	0.089	0.071	0.065	0.060	0.055
330uF 50V	<i>electrolyt.cap.EA-7 330uF 50V 12.5x20.5 mm</i>	0.112	0.101	0.093	0.087	0.080
330uF 63V	<i>electrolyt.cap.EA-7 330uF 63V 12.5x24.5 mm</i>	0.160	0.144	0.133	0.124	0.114
330uF 100V	<i>electrolyt.cap.EA-7 330uF 100V 16x31.5 mm</i>	0.356	0.320	0.295	0.274	0.254
470uF 6.3V	<i>electrolyt.cap.EA-7 470uF 6.3V 8x14 mm</i>	0.050	0.035	0.033	0.030	0.028
470uF 10V	<i>electrolyt.cap.EA-7 470uF 10V 8x14 mm</i>	0.052	0.037	0.034	0.031	0.029
470uF 16V	<i>electrolyt.cap.EA-7 470uF 16V 10x16.5 mm</i>	0.059	0.047	0.043	0.040	0.037
470uF 25V	<i>electrolyt.cap.EA-7 470uF 25V 10x20.5 mm</i>	0.089	0.071	0.065	0.060	0.055
470uF 35V	<i>electrolyt.cap.EA-7 470uF 35V 10x20.5 mm</i>	0.111	0.088	0.081	0.075	0.069
470uF 50V	<i>electrolyt.cap.EA-7 470uF 50V 12.5x24.5 mm</i>	0.163	0.148	0.126	0.117	
470uF 63V	<i>electrolyt.cap.EA-7 470uF 63V 12.5x24.5 mm</i>	0.226	0.205	0.174	0.161	
470uF 100V	<i>electrolyt.cap.EA-7 470uF 100V 16x35.5 mm</i>	0.416	0.370	0.330	0.308	
1000uF 6.3V	<i>electrolyt.cap.EA-7 1000uF 6.3V 10x16.5 mm</i>	0.073	0.058	0.053	0.049	0.045
1000uF 10V	<i>electrolyt.cap.EA-7 1000uF 10V 10x16.5 mm</i>	0.075	0.060	0.055	0.051	0.047
1000uF 16V	<i>electrolyt.cap.EA-7 1000uF 16V 10x20.5 mm</i>	0.072	0.065	0.060	0.056	0.052
1000uF 25V	<i>electrolyt.cap.EA-7 1000uF 25V 12.5x20.5 mm</i>	0.133	0.121	0.102	0.095	
1000uF 35V	<i>electrolyt.cap.EA-7 1000uF 35V 12.5x24.5 mm</i>	0.162	0.147	0.125	0.116	

Electrolytic capacitors		1-9	10-99	100-499	500+	2000+
1000uF 50V	electrolyt.cap.EA-7 1000uF 50V 16x25 mm	0.283	0.257	0.219	0.202	
1000uF 63V	electrolyt.cap.EA-7 1000uF 63V 16x35.5 mm	0.370	0.335	0.285	0.264	
2200uF 6.3V	electrolyt.cap.EA-7 2200uF 6.3V 12.5x20.5 mm	0.129	0.117	0.100	0.092	
2200uF 10V	electrolyt.cap.EA-7 2200uF 10V 12.5x20.5 mm	0.134	0.122	0.104	0.096	
2200uF 16V	electrolyt.cap.EA-7 2200uF 16V 12.5x24.5 mm	0.155	0.141	0.120	0.111	
2200uF 25V	electrolyt.cap.EA-7 2200uF 25V 16x25 mm	0.249	0.221	0.197	0.185	
2200uF 35V	electrolyt.cap.EA-7 2200uF 35V 16x31.5 mm	0.319	0.283	0.253	0.236	
2200uF 50V	electrolyt.cap.EA-7 2200uF 50V 18x37.5 mm	0.599	0.532	0.474	0.443	
3300uF 6.3V	electrolyt.cap.EA-7 3300uF 6.3V 12.5x24.5 mm	0.150	0.133	0.119	0.111	
3300uF 10V	electrolyt.cap.EA-7 3300uF 10V 12.5x24.5 mm	0.154	0.137	0.122	0.114	
3300uF 16V	electrolyt.cap.EA-7 3300uF 16V 16x25 mm	0.251	0.223	0.199	0.186	
3300uF 25V	electrolyt.cap.EA-7 3300uF 25V 16x31.5 mm	0.344	0.306	0.272	0.255	
3300uF 35V	electrolyt.cap.EA-7 3300uF 35V 18x37.5 mm	0.600	0.533	0.476	0.444	
4700uF 6.3V	electrolyt.cap.EA-7 4700uF 6.3V 16x25 mm	0.233	0.207	0.184	0.172	
4700uF 10V	electrolyt.cap.EA-7 4700uF 10V 16x25 mm	0.250	0.223	0.198	0.185	
4700uF 16V	electrolyt.cap.EA-7 4700uF 16V 16x31.5 mm	0.346	0.307	0.274	0.256	
4700uF 25V	electrolyt.cap.EA-7 4700uF 25V 18x37.5 mm	0.508	0.451	0.402	0.376	
6800uF 6.3V	electrolyt.cap.EA-7 6800uF 6.3V 16x25 mm	0.428	0.380	0.339	0.317	
10000uF 10V	electrolyt.cap.EA-7 10000uF 10V 16x31.5 mm	0.829	0.736	0.657	0.614	
10000uF 16V	electrolyt.cap.EA-7 10000uF 16V 18x37.5 mm	1.040	0.924	0.824	0.770	
1F 5.5V	Memory Back-up cap. 1 Farad 5.5V	2.497	2.137	1.997		
Batteries		1-9	10-99	100-499	500+	
3.6V 60mAh	PCB Battery 3.6V 60mAh	1.372	1.271	1.149	1.017	
CR2032-H	Lithium battery, 3V 180mAh, horizontal mount	0.478	0.443	0.400	0.354	
CR2032-V	Lithium battery, 3V 180mAh, vertical mount	0.478	0.443	0.400	0.354	
Development tools						1+
AC004001	PROMATE Serial E2 24,25,93,HCS30X Socket					159.000
AC004004	ICSP Programming Socket for PRO MATE-II					349.000
AC124001	PROMATE PIC12C508/509 DIP/SOIC Socket					129.000
AC164001	PROMATE PIC16C52,54,55,56,57,58A Socket					159.000
AC164010	PROMATE PIC16C61,71,83,84...DIP/SOIC Socket					159.000
AC164012	PROMATE PIC16C62,63,64,65,72,73,74 Socket					159.000
AC164013	PROMATE PIC16C64, 65, 67, 74, 77 PLCC Socket					159.000
AC164014	PROMATE PIC16C64, 65, 67, 74, 77 PQFP Socket					159.000
AC164017	PROMATE II PIC16C62, 63, 66, 642, 72, 73, 76, 773, 87					159.000
AC164024	PICSTART PLUS PIC 17C756 Socket					129.000
AC165213	ICEPIC PIC16C642, 662 Daughter Board					349.000
DM303002	HCS300 Demo/Eval Kit					296.000
DM303003	HCS410 Transponder Demo/Eval Kit					323.000
DV164001	MPLAB In-Circuit Debugger for PIC16F87XX					159.000
DV164002	MPLAB In-Circuit Debugger Module for PIC16F87XX					99.000
DVMCPA	MXDEV 1 Analog Evaluation System Driver Board					169.000
DVA12XP080	PIC12C50X PDIP and SOIC 8 LD Device Adapter					125.000
DVA12XP081	PIC12CE51X,CE67X PDIP,SOIC(207 mil)8 LD Device A					125.000
DVA16XP180	PIC16C52,54,54A,54B,56,56A,58A,58B,55A,55B,62X					125.000
DVA16XP280	PIC16C55,55A,57,57C LD Device Adapter					125.000
DVA16XP282	PIC16C62A, 63, 63A, 642, 66, 72, 72A, 73A, 73B, 76, 77					165.000
DVA16XP401	PIC16C62A, 63, 63A, 642, 66, 72, 72A, 73A, 73B, 76, 77					165.000
DVA18PQ640	PIC18C658 TQFP 64 LD Device Adapter*					225.000
DVA18XL680	PIC18C658 TQFP 64 LD Device Adapter*					225.000
FUZZY TECH Explorer	fuzzyTECH MP PIC16/17 Explorer					239.000
ICE2000	MPLAB-ICE 2000 Univ.Emulator Pod Kit					1525.000
PCM16XAO	PIC12C50X, CE51X, C505, 5X Processor Module					445.000
PCM16XE1	PIC12C50X, CE51X, C505, 5X Processor Module					445.000
PCM16XK0	PIC12C50X, CE51X, C505, 5X Processor Module					445.000
PCM16XQ0	PIC12C50X, CE51X, C505, 5X Processor Module					445.000
PCM18XB0	PIC18CXX8 Processor Module					445.000
PICSTART PLUS	PIC - Microchip Development System					199.000
PROMATE II	Programmer PIC,24CXX,25CXX,93CXX,HCS30X					695.000
SW006010 MPLAB-C17	C Compiler for PIC17CXXX Family					495.000

Development tools

			1+
SW006010	MPLAB-C18	C Compiler for PIC18CXXX Family	495.000
UK303005		DM303003 Upgrade Kit, to HCS412	99.000
DM163001		PICDEM-1 DEMO BOARD	99.000
DM163002		PICDEM-2 DEMO BOARD	99.000
DM163004		PICDEM-net DEMO BOARD	299.000
UK163002		Internet Ready Upgrade Kit for PICDEM-2	9.000
SIMICE5X		PIC12C5xx & 16C5x non real time emulator	114.000
TRAC DEV KIT		Trac Development Kit for 2 TRAC020 IC	436.000

Enclosures

		1-4	5-24	25-99	100+	
DX01	enclosure	W127xL80xH30	2.619	2.305	2.179	2.095
DX02	enclosure	W160xL120xH50	8.683	7.641	7.224	6.946
DX04	enclosure	W260xL210/195xH85/65	34.129	30.947	30.079	28.923
KM13	remote control enclosure		0.719	0.633	0.598	0.575
KM20	enclosure	69X20X9	0.504	0.444	0.420	0.404

Enclosures PacTec www.pactecenclosures.com

		1-4	5-24	25-99	100+	
C-200 KIT BLACK	enclosure	W215.9xL234.95xH61.98	24.799	23.692	22.806	22.142
CB-23 BLACK	enclosure	W215.9xL234.95xH61.98	24.446	23.355	22.481	21.827
CF-125 BLACK	enclosure	W212.34xL231.39xH41.91	16.854	15.997	15.140	14.283
CF-125 PC-BONE	enclosure	W212.34xL231.39xH41.91	16.854	15.997	15.140	14.283
CF-225 BLACK	enclosure	W212.34xL231.39xH67.31	17.500	16.610	15.720	14.830
CF-275 PC-BONE	enclosure	W212.34xL231.39xH80.01	17.809	16.904	15.998	15.093
CLLP-34 BLACK	enclosure	W318.01xL295.66xH89.15 to 108.2	41.117	39.282	37.813	36.712
CLLP-34 PC BONE	enclosure	W318.01xL295.66xH89.15 to 108.2	41.117	39.282	37.813	36.712
CLLP-300 BLACK	enclosure	W318.01xL295.66xH89.15	44.844	42.842	41.241	40.039
CLLP-375 BLACK	enclosure	W318.01xL295.66xH108.2	35.941	34.336	33.053	32.090
CLLPH-300 BLACK	enclosure	W318.01xL295.66xH89.15	61.778	59.021	56.814	55.159
CM69-120 PC-BONE	enclosure	W160.8xL241.3xH35.1	14.910	14.152	13.393	12.635
CM69-120 GREY	enclosure	W160.8xL241.3xH35.1	14.910	14.152	13.393	12.635
CM79-125 PC-BONE	enclosure	W189.23xL237.74xH31.75	15.844	15.038	14.233	13.427
CNL-0006 PC-BONE	enclosure	W 63.5 Blank end/DB-25(CC)	4.916	4.666	4.416	4.166
CR-48 BLACK	enclosure	W119.4xL215.9xH43.9	9.866	8.796	8.413	7.648
DM-2 BLACK	enclosure	W264.2xL291.1xH60.5	24.768	23.663	22.778	22.115
DM-2 PC-BONE	enclosure	W264.2xL291.1xH60.5	24.768	23.663	22.778	22.115
FLX-6030 BLACK	enclosure	W152.4xL76.2xH50.8	6.684	5.959	5.700	5.181
FLX-6030 PC-BONE	enclosure	W152.4xL76.2xH50.8	6.684	5.959	5.700	5.181
FLXT-2535-028 BLACK	enclosure	W63.5xL88.9xH28.45	3.671	3.273	3.130	2.846
FLXT-2535-060 PC-BONE	enclosure	W63.5xL88.9xH28.45	3.671	3.273	3.130	2.846
FLXT-4624-028 BLACK	enclosure	W116.84xL60.96xH33.53	4.067	3.626	3.468	3.153
FLXT-4624-060 PC-BONE	enclosure	W116.84xL60.96xH33.53	4.067	3.626	3.468	3.153
HM-9VB BC BLACK	enclosure	W61.0xL96.5xH25.4 9V PANEL clips	4.588	4.090	3.912	3.557
HM-9VB BLACK	enclosure	W61.0xL96.5xH25.4 9V PANEL	8.850	4.323	4.135	3.759
HM-9VB PC-BONE	enclosure	W61.0xL96.5xH25.4 9V PANEL	8.850	4.323	4.135	3.759
HML-9VB KIT BLACK	enclosure	W69.9xL116.8xH25.4	7.046	6.281	6.008	5.462
HML-9VB KIT PC-BONE	enclosure	W69.9xL116.8xH25.4	7.046	6.281	6.008	5.462
HP-000 BLACK	enclosure	W91.4xL146.1xH257	4.625	4.123	3.944	3.586
HP-9VB BLACK	enclosure	W91.4xL146.1xH257	5.372	4.789	4.581	4.164
HPL-4AA BLACK	enclosure	W101.6xL190.5xH32.8	6.584	5.869	5.614	5.104
HPL-6AA PC-BONE	enclosure	W101.6xL190.5xH32.8	7.992	7.125	6.815	6.196
HPLS-48 PC-BONE	enclosure	W105.9xL215.9xH43.9/65	8.672	7.731	7.395	6.722
HPLS-4AA BLACK	enclosure	W101.6xL190.5xH32.8/57.4	7.581	6.758	6.464	5.876
HPLS-9VB BLACK	enclosure	W101.6xL190.5xH32.8/57.4	6.965	6.209	5.939	5.399
HPLS-9VB PC-BONE	enclosure	W101.6xL190.5xH32.8/57.4	7.026	6.264	5.992	5.447
HPS-9VB BLACK	enclosure	W91.4xL146.1xH32.8/53.1	7.280	6.490	6.208	5.644
HPS-9VB PC-BONE	enclosure	W91.4xL146.1xH32.8/53.1	6.049	5.393	5.158	4.689
HPS-LP BLACK	enclosure	low prof. W91.4xL146.1xH20.6/40.9	7.165	6.387	6.110	5.554
HR-9VB BLACK	enclosure	W82.6xL146.1xH24.1	5.742	5.119	4.897	4.451
HR-9VB PC-BONE	enclosure	W82.6xL146.1xH24.1	5.742	5.119	4.897	4.451
KE-12 BLACK	enclosure	W315.0xL165.1xH38.1	13.939	13.230	12.521	11.813
KE-17 KIT PC-BONE	enclosure	W433.8xL220.5xH70.9	35.011	33.448	32.197	31.259
KE-20 KIT PC-BONE	enclosure	W510.0xL220.5xH70.9	40.572	38.761	37.312	36.225
KEU-10LP BLACK	enclosure	W254.0xL204.0xH51.8	15.673	13.972	13.365	12.610
KEU-10LP PC-BONE	enclosure	W254.0xL204.0xH51.8	15.673	13.972	13.365	12.510

Enclosures PacTec www.pactecenclosures.com

		1-4	5-24	25-99	100+
KEU-7LP BLACK	enclosure W177,8xL127,0xH33	10.759	9.591	9.174	8.340
KEU-5LP BLACK	enclosure W137,2xL137,7xH40,4	7.373	6.573	6.287	5.715
KEU-5LP PC-BONE	enclosure W137,2xL137,7xH40,4	7.373	6.573	6.287	5.715
KR-1 BLACK	enclosure W35,6xL58,4xH11,4	4.172	3.554	3.245	3.090
LH43-200 BLACK	enclosure W114,3xL76,2xH44,45	7.431	6.624	6.336	5.760
LH43-200 PC-BONE	enclosure W114,3xL76,2xH44,45	7.431	6.624	6.336	5.760
LH64-130 BLACK	enclosure W154,43xL108,2xH38,1	10.124	9.025	8.633	7.848
LH64-130 PC-BONE	enclosure W154,43xL108,2xH38,1	10.124	9.025	8.633	7.848
LH96-130 BLACK	enclosure W230,63xL159,0xH38,1	11.939	11.332	10.725	10.118
LH96-130 PC-BONE	enclosure W230,63xL159,0xH38,1	11.939	11.332	10.725	10.118
LH96-200 BLACK	enclosure W230,63xL159,0xH57,15	13.108	12.442	11.775	11.109
LH96-200 PC-BONE	enclosure W230,63xL159,0xH57,15	13.108	12.442	11.775	11.109
PS36-200 BLACK	enclosure W82,04xL148,59xH48,01	7.012	5.973	5.454	5.194
RCS24-9VB/2AA BLACK	enclosure W63,5xL116,84xH22,86	5.757	5.132	4.909	4.463
RCS24-9VB/2AA PC-BONE	enclosure W63,5xL116,84xH22,86	5.757	5.132	4.909	4.463
RM-178 BLACK	enclosure W431,8xL203,26xH43,18	29.681	28.356	27.296	26.501
RM-178 PC-BONE	enclosure W431,8xL203,26xH43,18	29.681	28.356	27.296	26.501
TS BLACK	enclosure W83,57xL184,66xH31,75	8.431	7.516	7.189	6.536
TS PC-BONE	enclosure W83,57xL184,66xH31,75	8.431	7.516	7.189	6.536
TS-9VB/2AA BLACK	enclosure W83,57xL184,66xH34,29	9.224	8.223	7.865	7.150
TS-9VB/2AA PC-BONE	enclosure W83,57xL184,66xH34,29	9.212	8.212	7.855	7.141
TT BLACK	enclosure W112,8/83,6xL216,41xH29,2/38,1	9.551	8.514	8.144	7.404
TT PC-BONE	enclosure W112,8/83,6xL216,41xH29,2/38,1	9.551	8.514	8.144	7.404
TT-1(2) 9VB/4AA BLACK	enclosure W112,8/83,6xL216,41xH29,2/38,1	11.887	10.596	10.136	9.214
TT-9VB/2AA BLACK	enclosure W112,8/83,6xL216,41xH29,2/38,1	10.024	8.936	8.548	7.771
TT-9VB/2AA PC-BONE	enclosure W112,8/83,6xL216,41xH29,2/38,1	10.024	8.936	8.548	7.771
WM-46 PC-BONE	enclosure W95,25xL133,35xH25,40	4.479	3.993	3.819	3.472
WM-56 BLACK	enclosure W154,94xL129,54xH38,1	5.834	5.200	4.974	4.522

Enclosures BERNIC www.bernic.dk

		1-4	5-24	25-99	100+
Series 200:					
BE2069201001	Type 201, grey body / lid	3.251	2.860	2.704	2.600
BE2069201002	Type 201, grey body / clear lid	3.251	2.860	2.704	2.600
BE2069203001	Type 203, grey body / lid	5.705	5.021	4.747	4.564
BE2069205001	Type 205, grey body / lid	6.086	5.356	5.064	4.869
BE2069205002	Type 205, grey body / clear lid	6.086	5.356	5.064	4.869
BE2069212001	Type 212, grey body / lid	7.215	6.349	6.003	5.772
BE2069212002	Type 212, grey body / clear lid	7.215	6.349	6.003	5.772
BE2069214001	Type 214, grey body / lid	11.314	9.956	9.413	9.051
BE2069214232	Type 214, grey body / clear lid	11.314	9.956	9.413	9.051
BE2069218001	Type 218, grey body / lid	14.024	12.341	11.668	11.219
BE2069218002	Type 218, grey body / clear lid	14.024	12.341	11.668	11.219
BE2069232001	Type 232, grey body / lid	15.023	13.220	12.499	12.018
BE2069232002	Type 232, grey body / clear lid	15.023	13.220	12.499	12.018
BE2069238001	Type 238, grey body / lid	22.067	4.000	18.360	17.654
BE2069238002	Type 238, grey body / clear lid	22.067	4.000	18.360	17.654
BE2069265001	Type 265, grey body / lid	8.008	7.047	6.663	6.407
BE2069265002	Type 265, grey body / clear lid	8.008	7.047	6.663	6.407
BE2069287001	Type 265, grey body / lid	12.789	11.255	10.641	10.231
BE2069202501	Type 2025, grey body / lid	20.859	18.356	17.355	16.687
BE2069202502	Type 2025, grey body / clear lid	20.859	18.356	17.355	16.687
Series 301:					
BE0669001301	Type 201, grey body / lid	2.438	2.145	2.028	1.950
Series 350:					
BE4969010351	Complete, 257 for plugable	2.677	2.356	2.228	2.142
BE4969010352	Complete, 605 for fixed or screw-less term.	2.677	2.356	2.228	2.142
BE4969010350	Complete, closed, no terminals	2.677	2.356	2.228	2.142
BE4969001350	Complete, closed, no terminals	0.387	0.341	0.322	0.310
BE4969002350B+C	Complete, closed, no terminals	1.503	1.323	1.251	1.203
Series 400:					
BE2069401001	Type 401, grey, complete	1.939	1.706	1.613	1.551
BE2069403001	Type 403, grey, complete	1.939	1.706	1.613	1.551
BE2069404001	Type 403, grey, complete	2.552	2.246	2.123	2.042

Enclosures BERNIC www.bernic.dk

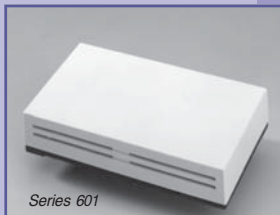
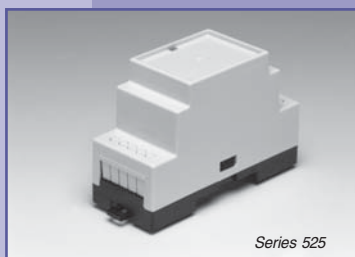
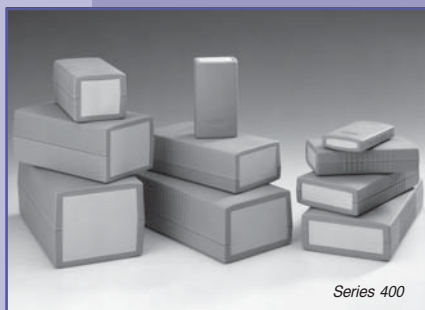
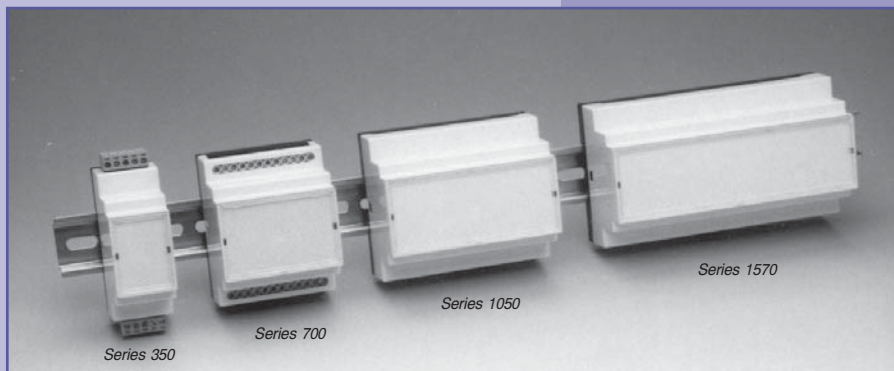

Enclosures BERNIC www.bernic.dk		1-4	5-24	25-99	100+
BE2069407001	Type 407, grey, complete	2.678	2.357	2.228	2.143
BE2069421001	Type 421, grey, complete	6.577	5.788	5.472	5.262
Series 450:					
BE4969003450	Complete, incl. DIN-rail clip and 5 + 7 terminals	6.028	5.304	5.015	4.822
BE4969000450	Top part without terminals	1.196	1.052	0.995	0.956
BE4969002450	Base part, without DIN-rail clip	2.478	2.180	2.061	1.982
BE669000605	DIN-rail clip	0.162	0.143	0.135	0.130
Series 503:					
BE2069000508	Base part, black, RAL 7022	0.854	0.752	0.711	0.683
BE20690040500	Cover, black, RAL 7022	2.227	1.960	1.853	1.782
BE1961310090	Cable screw joint, black, O4 - 8 mm	1.009	0.888	0.839	0.807
Series 525:					
BE4969004525	Complete with 14 terminals/screws	3.791	3.336	3.154	3.033
Series 600:					
BE669000600	Top part	1.587	1.397	1.321	1.270
BE669000609	Base part incl. 2 screws	1.511	1.330	1.257	1.209
BE669000603	Knob without print	0.276	0.243	0.230	0.221
Series 601:					
BE601-COMPL	Top part+Base part, screws	2.999	2.639	2.495	2.399
BE669000602	Top part	1.587	1.397	1.321	1.270
BE669000609	Base part incl. 2 screws	1.511	1.330	1.257	1.209
Series 602:					
BE602-COMPL	Top part, Base part, Screw	3.107	2.734	2.585	2.485
BE669000606	Top part	1.624	1.429	1.351	1.299
BE669001622	Base part with integrated spacer	1.511	1.330	1.257	1.209
BE2069441331	Self-threading screw, part 602	0.094	0.085	0.073	0.067
Series 700:					
BE4969010701	Complete, 257 for plugable	3.107	2.734	2.585	2.485
BE4969010702	Complete, 605 for fixed or screw-less term.	3.107	2.734	2.585	2.485
BE4969010700	Complete, closed, no terminals	3.054	2.687	2.541	2.443
BE4969001700	Complete, closed, no terminals	0.426	0.375	0.354	0.341
BE1155612080	Terminal for 700, 256/12, wire part	3.467	3.051	2.885	2.774
Series 1050:					
BE4969101051	Complete, 257 for plugable	3.823	3.365	3.181	3.059
BE4969101052	Complete, 605 for fixed or screw-less term.	3.823	3.365	3.181	3.059
BE4969101050	Complete, closed, no terminals	3.823	3.365	3.181	3.059
BE4969011050	Transparent lid for Type 1050	0.531	0.467	0.442	0.425
BE4969001050	Type 1050 top part gray/closed	2.016	1.774	1.678	1.613
BE1155618080	Terminal for 1050, 256/18, wire part	5.325	4.686	4.430	4.260
BE4969100041	Type 1050 top part gray/closed	0.774	0.682	0.644	0.620
Series 1000:					
BE4969113102	Type 1131 ABS clear/grey	5.521	4.859	4.594	4.417
BE4969113101	Type 1131 ABS grey/grey	4.861	4.278	4.045	3.889
Series 1168:					
BE4969116802	Complete	4.308	3.791	3.584	3.446
Series 1570:					
BE4969101571	Complete, 257 for plugable	4.354	3.832	3.623	3.483
BE4969101572	Complete, 605 for fixed or screw-less term.	4.354	3.832	3.623	3.483
BE4969101570	Complete, closed, no terminals	4.260	3.749	3.545	3.408
BE4969011570	Transparent lid for Type 1570	0.650	0.572	0.541	0.520
BE4969001570	Type 1570 top part grey/closed	2.309	2.032	1.921	1.847
BE1155613080	Terminal for 1570, 256/13, wire part	3.756	3.306	3.125	3.005
Series 2000:					
BE4969832011	Type 2011S, grey, ABS	3.889	3.422	3.235	3.111
BE4969852011	Type 2011L, grey, ABS	4.770	4.197	3.968	3.816
BE4969842051	Type 2051M, grey, ABS	6.336	5.576	5.271	5.069

Enclosures BERNIC www.bernic.dk

		1-4	5-24	25-99	100+	1000+
BE4969852051	Type 2051L, grey, ABS	7.714	6.789	6.418	6.171	
BE4969842091	Type 2091M, grey, ABS	14.146	12.448	11.769	11.317	
BE4969852091	Type 2091L, grey, ABS	11.929	10.497	9.925	9.543	
Series 2100:						
BE4969118301	Type 21183G, grey	5.761	5.069	4.793	4.609	
BE4969118302	Type 21183B, black	5.761	5.069	4.793	4.609	
BE4969118801	Type 21188G, grey	5.761	5.069	4.793	4.609	
BE4969118802	Type 21188B, black	4.926	4.335	4.098	3.941	
Series 3000:						
BE4969883001	Type 3001, grey, sealed	4.292	3.777	3.571	3.434	
BE4969863001	Type 3001, black, sealed	4.167	3.667	3.467	3.334	
BE4969883041	Type 3041, grey, sealed	5.486	4.827	4.564	4.389	
BE4969863041	Type 3041, black, sealed	5.486	4.827	4.564	4.389	
BE4969883068	Type 3068, grey complete	1.957	1.722	1.628	1.565	
Series 3600:						
BE669000605	DIN-rail clip for 3636	0.162	0.143	0.135	0.130	
BE669000604	DIN-rail clip for type 3670-36158	0.145	0.127	0.120	0.116	
BE4969002350	Type 3635 base without clip/screws	1.204	1.060	1.002	0.963	
BE4969002700	Type 3670 base without clip/screws	1.426	1.255	1.187	1.141	
BE4969021050	Type 36105 base without clip/screws	1.602	1.410	1.333	1.282	
BE4969021570	Type 36157 base without clip/screws	1.744	1.534	1.451	1.395	
Rubber Feet:						
BE4972000672	Adhesive black, O13 mm (One each)	0.059	0.053	0.047	0.044	
BE2069440999	Adhesive black, O11.26 mm (Four each)	0.094	0.084	0.075	0.070	
BE4969624021	Adhesive black, 12.0 x 12.0 x 5.6 mm	0.059	0.053	0.047	0.044	
BE4972001183	Adhesive black, 10.0 x 13.0 x 3.7 mm	0.059	0.053	0.047	0.044	
BE4969611953	O28, center hole O6.0 mm (One each)	0.169	0.150	0.134	0.125	
BE4969611950	O30, center hole O8.0 mm, (One each)	0.169	0.150	0.134	0.125	
Series NOVA						
BE4969063001	Type NOVA63	5.149	4.577	4.081	3.814	
BE4969127001	Type NOVA127	6.283	5.584	4.979	4.654	